

INSTRUCTION

Flat Slim Round
312634.002.76



~ 220 - 240 V 50/60 Hz IP 65 IK02



 5 x 0,75 - 2,5 mm²



Umgebungstemperatur /
temperature ambiante
=> -20 °C ... + 45 °C

 2,50 mm²

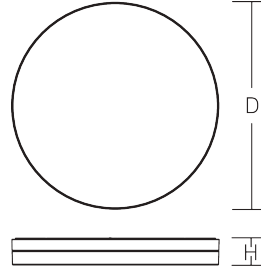

D 480, H 70



4,19 kg



Φ_{lm} [lm]

P_{lm} [W]

P_{lm}

LED

5000

39

1 x 34 W

CCT [K]

CRI

RG lm

EEK lm

3000

80

RG 1

D

I_{max} $\frac{I_{\text{max}}}{2}$
T50

COS φ

10 A / 200 μ s

0,95





Installation erfordert
Elektro-Fachkraft!

Symbole nach ISO 7010



Allgemeine Sicherheitshinweise

- Der elektrische Anschluss muss ordnungsgemäß nach geltenden Normen und den nationalen sowie internationalen Sicherheits- und Unfallverhütungsvorschriften erfolgen.
- Beschädigte Leuchten dürfen nicht betrieben werden.
- Keine Haftung für Schäden durch unsachgemäßen Einsatz.
- Bei Instandsetzung nur Originalteile verwenden.
- Tragfähigkeit der Decke und Befestigungselemente sicherstellen.

Betrieb der Leuchte

- Die unzulässigen Umgebungstemperaturen reduzieren die Lebensdauer der Leuchte, im Extremfall droht der Frühausfall.
- Zur Vermeidung von EMV-Problemen die Durchgangsverdrahtung nicht entlang der Leuchtenverdrahtung führen.
- Steuereingänge von dimmbaren Leuchten mit handelsüblichen für Netzspannung geeigneten Leitungen anschließen.

Manipulationen unserer Produkte sind unzulässig

Veränderung, Umarbeitung, Umkennzeichnung von Produkten sowie deren Verpackung sind unzulässig und verletzen u.a. unsere eingetragenen Warenzeichenrechte. Solche Modifikationen können technische Eigenschaften unserer Produkte negativ beeinflussen, diese zerstören und möglicherweise Folgeschäden an anderen Objekten verursachen. Für durch derartige Modifikationen verursachte Schäden kann der Hersteller in keinem Fall verantwortlich gemacht werden.



Installation requires
a qualified electrician!

Symbols according
to ISO 7010



General Safety Information

- Electric connection must be appropriate according to all applicable standards and other national and international safety and accident prevention regulations.
- Damaged luminaires must not be operated.
- No liability is accepted for damages resulting from improper use.
- Use genuine parts only for repair.
- Ensure stability of the ceiling and fastening elements.

Operation of the luminaire

- Exceeding the permissible ambient temperature will reduce the luminaire's lifecycle, resulting in premature failure in extreme cases.
- Avoid ESD problems by not routing feed-through wiring directly along the wiring of the luminaire.
- Connect control inputs of dimmable luminaires with standard cables suitable for power supply voltage.

Manipulation of our products is not permitted

Modifications, reworking, re-labelling of products as well as their package is not permitted and infringes, amongst others, our registered trademark rights. Such modifications may affect technical properties of our products, damage them and possibly cause consequential damage to other objects. The manufacturer shall not be responsible under any circumstances for damage caused by such modifications.



Bei Fragen zu unseren Symbolen, besuchen Sie folgende Webseite:
If you have any questions about our signs, visit the following website:



https://www.rzb.de/fileadmin/assets/downloads/PDF/RZB_Symbolklaerung.pdf

EEK 

Dieses Produkt enthält eine Lichtquelle der Energieeffizienzklasse D entsprechend Verordnung (EU) 2019/2015

This product contains a light source of energy efficiency class D according to regulation (EU) No 2019/2015

 →  Jede zersprungene Schutzabdeckung ist zu ersetzen. DIN EN 60598

 →  Replace any cracked protective shield. IEC DIN EN 60598

Hinweis zum Einsatz von Leuchten mit D - Kennzeichnung nach EN 60598-2-24
Reference for application of lumiaires with D - marking according to EN 60598-2-24

	<u>Umgebung ohne Staubablagerung</u> <u>Environment without dust deposit</u>
	<u>Umgebung mit nicht elektrisch leitender Staubablagerung</u> <u>Environment with non-electrically conductive dust deposit</u>
	<u>Umgebung mit elektrisch leitender Staubablagerung</u> <u>Environment with electrically conductive dust deposit</u>

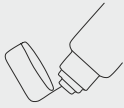

Apply Thinly

Das beigefügte Schmierfett dient als Montagehilfe und ist nur bei Bedarf zu verwenden. Falls Sie beim Aufschrauben des Glases auf die Armatur einen starken Widerstand spüren, geben Sie eine geringe Menge des Fetts auf die Dichtung.

The enclosed grease serves as an assembly aid and should only be used if necessary. If you feel strong resistance when screwing the glass onto the fitting, apply a small amount of the grease to the gasket.

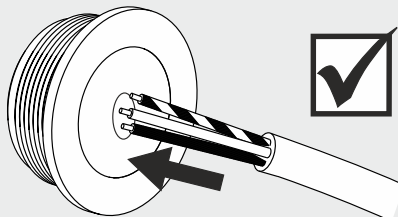

Ersatzteil
Spare part

2x



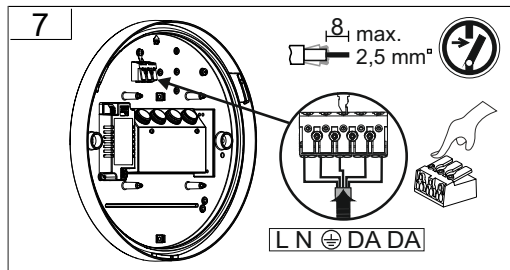
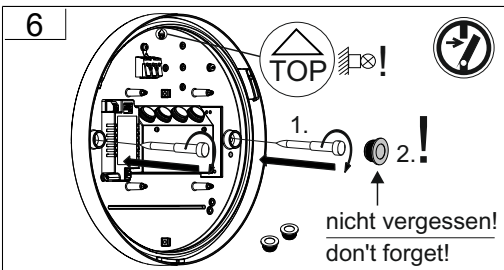
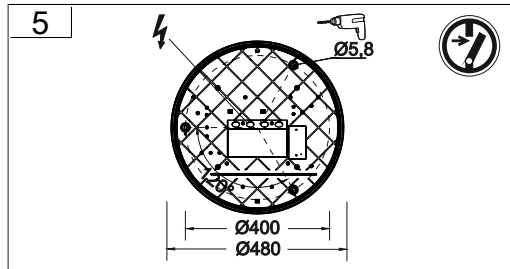
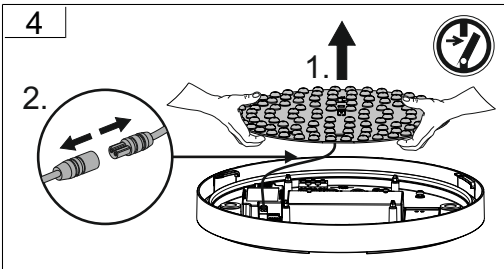
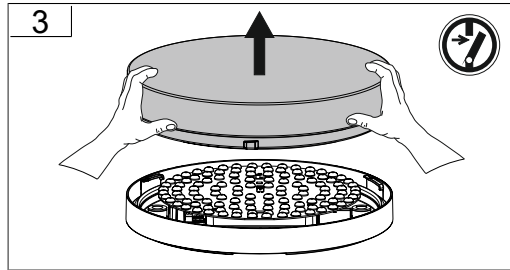
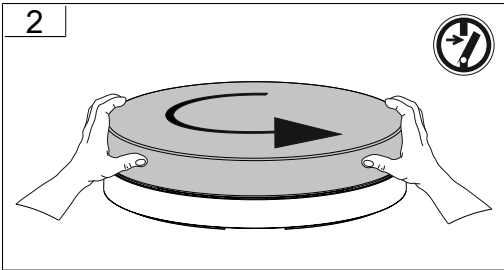

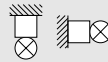

8

Konvertereinstellung / Converter setting

Iout	Pomax	5	4	3	2	1	
500 mA	25 W	-	-	-	on	on	
550 mA	27,5 W	-	-	on	-	-	
600 mA	30 W	-	-	on	-	on	
650 mA	32,5 W	-	-	on	on	-	
700 mA	35 W	-	-	on	on	on	3000K → 3450lm 4000K → 3600lm
750 mA	36 W	on	-	-	-	-	
800 mA	38,5 W	on	-	-	-	on	
850 mA	41 W	on	-	-	on	-	
900 mA	43,5 W	on	-	-	on	on	
950 mA	45,5 W	on	-	on	-	-	
1000 mA	48 W	on	-	on	-	on	
1050 mA	50,4 W	on	-	on	on	-	3000K → 5000lm 4000K → 5150lm
1100 mA	52,8 W	on	-	on	on	on	
1150 mA	53,5 W	on	on	-	on	-	
1200 mA	56 W	on	on	-	on	on	
1250 mA	58 W	on	on	on	-	-	

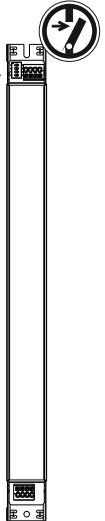

9

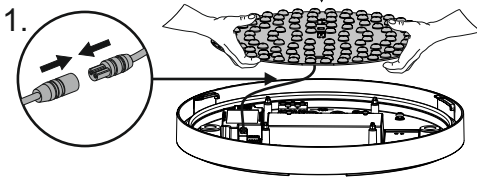

10

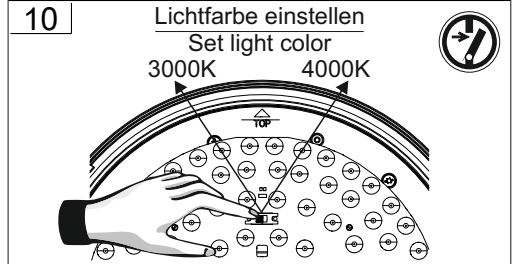

11

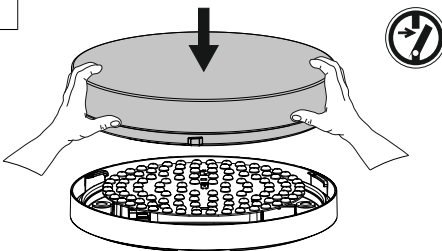

12

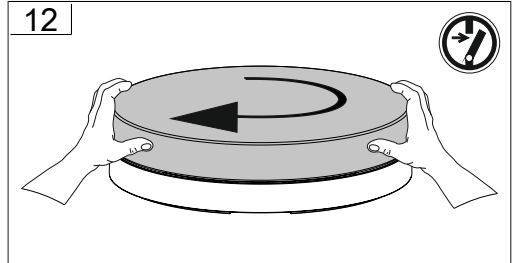

13

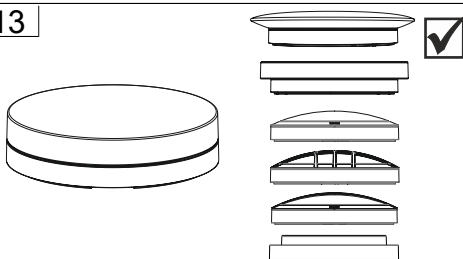

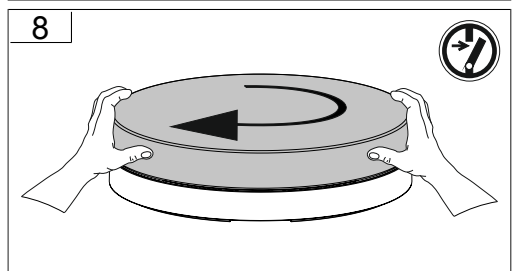
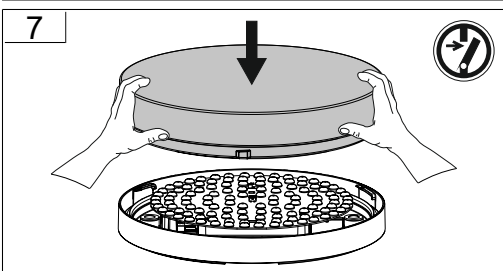
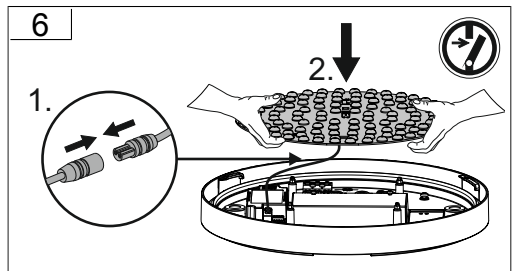
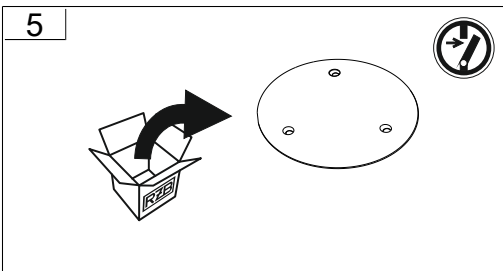
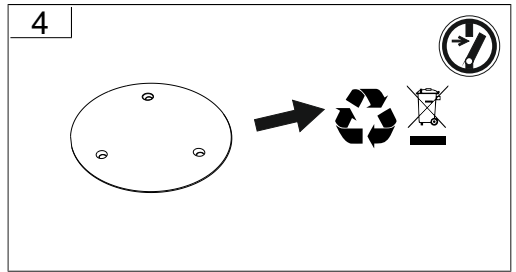
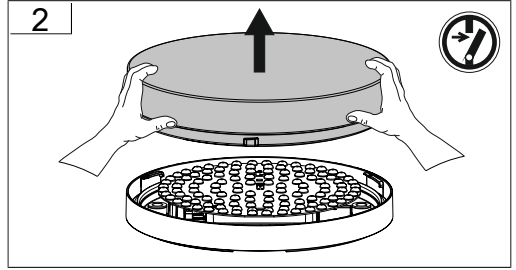

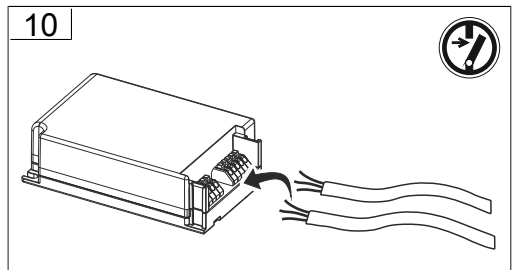
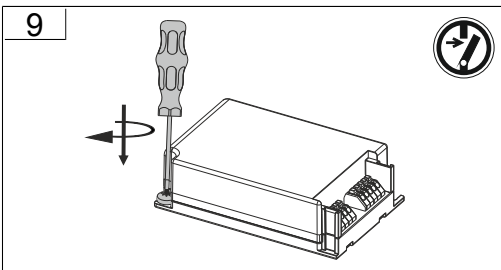
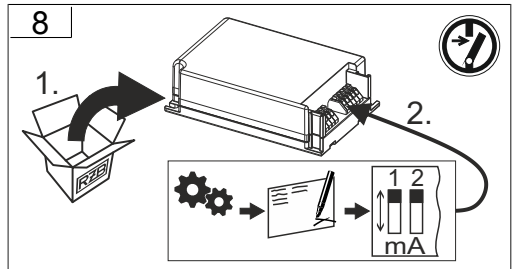
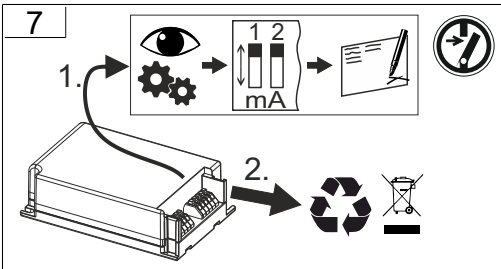
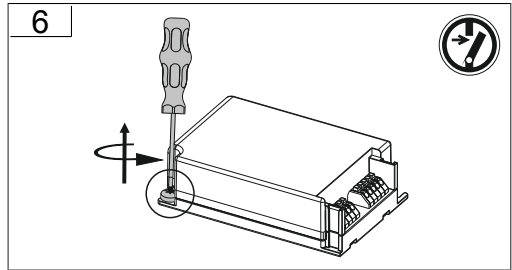
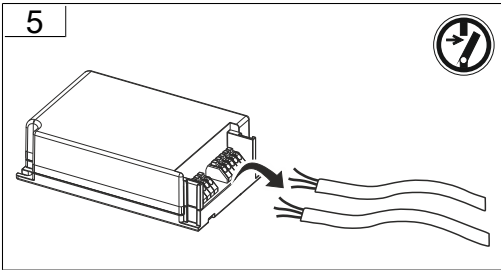
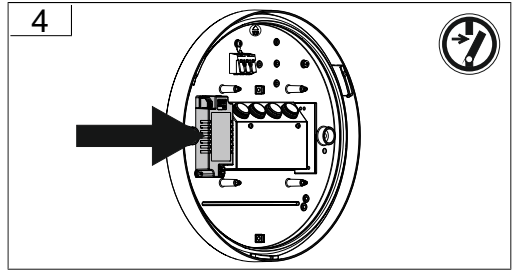
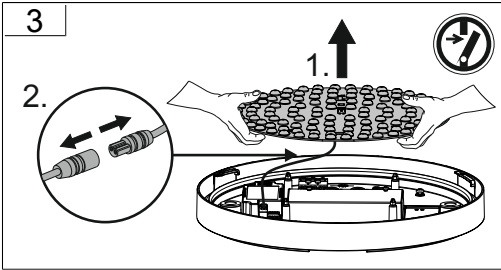
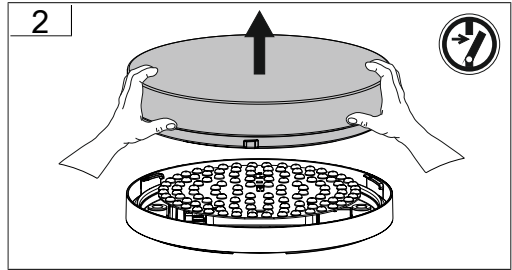
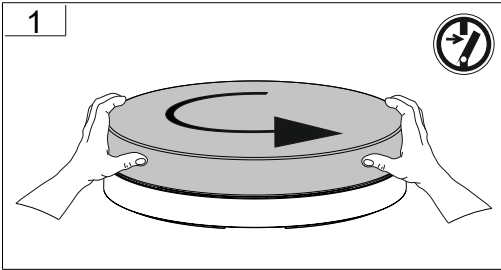

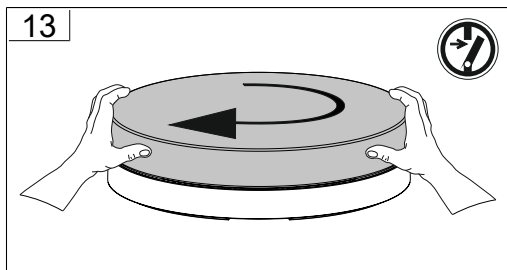
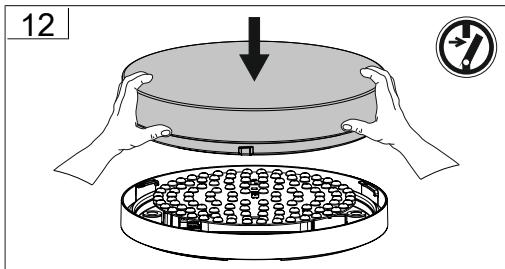
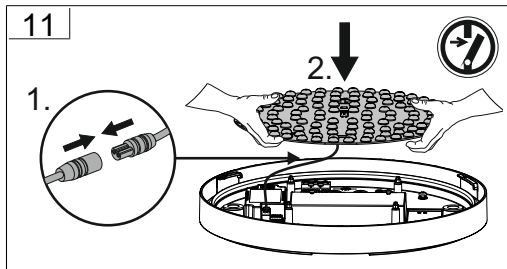

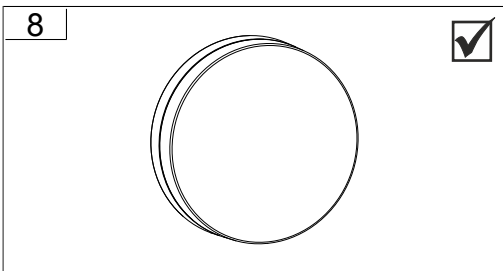
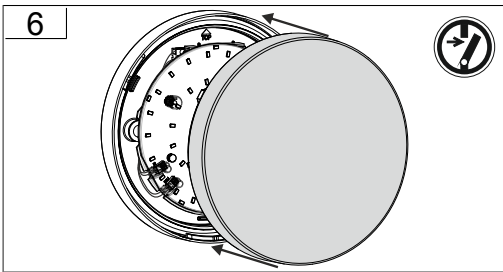
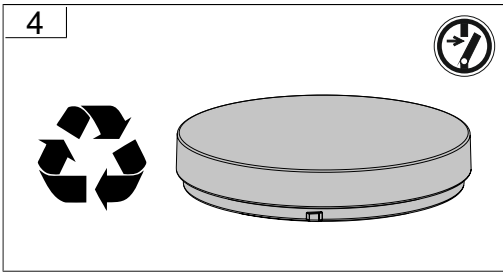
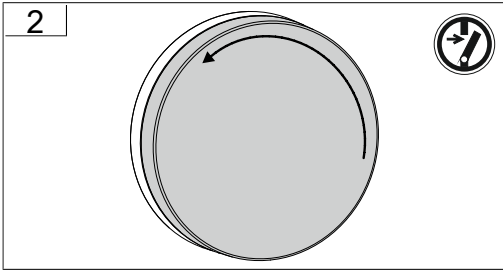









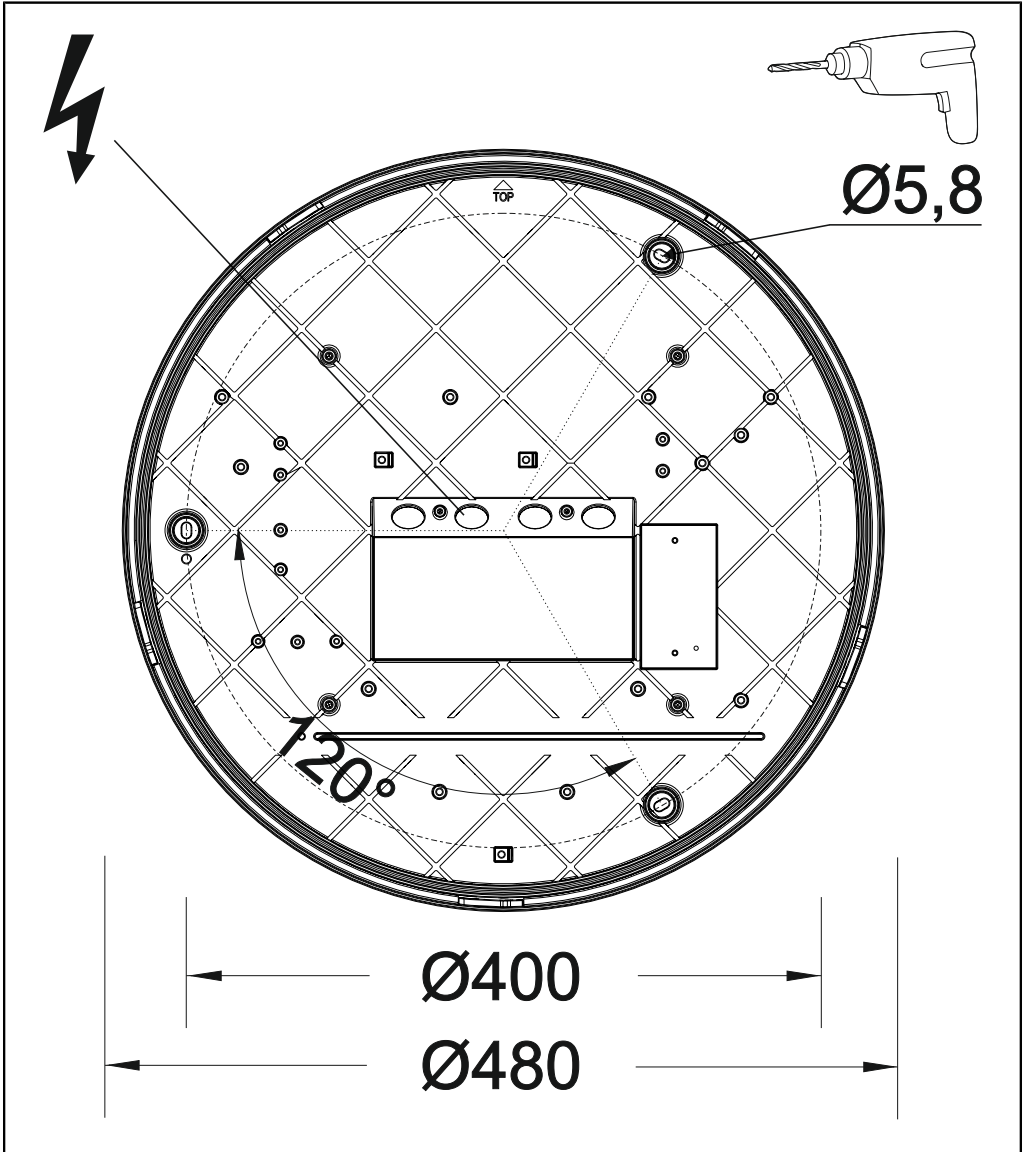

RZB - Rudolf Zimmermann, Bamberg GmbH

🏠 Rheinstraße 16, 96052 Bamberg

☎ 0951/7909-0

📠 0951/7909-198

🌐 info@rzb-leuchten.de