

INSTRUCTION

LINEDO
982775.002.1

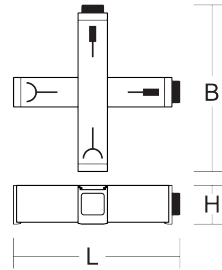

IP 20

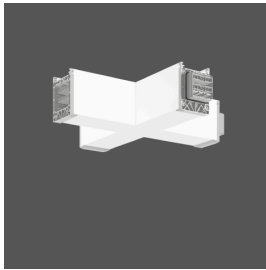

L 330, B 330, H 76



1230 g

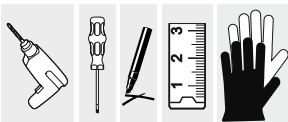



Allgemeine Sicherheitshinweise

- Der elektrische Anschluss muss ordnungsgemäß nach geltenden Normen und den nationalen sowie internationalen Sicherheits- und Unfallverhütungsvorschriften erfolgen.
- Beschädigte Leuchten dürfen nicht betrieben werden.
- Keine Haftung für Schäden durch unsachgemäßen Einsatz.
- Bei Instandsetzung nur Originalteile verwenden.
- Tragfähigkeit der Decke und Befestigungselemente sicherstellen.

Betrieb der Leuchte

- Die unzulässigen Umgebungstemperaturen reduzieren die Lebensdauer der Leuchte, im Extremfall droht der Frühausfall.
- Zur Vermeidung von EMV-Problemen die Durchgangsverdrahtung nicht entlang der Leuchtenverdrahtung führen.
- Steuereingänge von dimmbaren Leuchten mit handelsüblichen für Netzspannung geeigneten Leitungen anschließen.

Manipulationen unserer Produkte sind unzulässig

Veränderung, Umarbeitung, Umkennzeichnung von Produkten sowie deren Verpackung sind unzulässig und verletzen u.a. unsere eingetragenen Warenzeichenrechte. Solche Modifikationen können technische Eigenschaften unserer Produkte negativ beeinflussen, diese zerstören und möglicherweise Folgeschäden an anderen Objekten verursachen. Für durch derartige Modifikationen verursachte Schäden kann der Hersteller in keinem Fall verantwortlich gemacht werden.



General Safety Information

- Electric connection must be appropriate according to all applicable standards and other national and international safety and accident prevention regulations.
- Damaged luminaires must not be operated.
- No liability is accepted for damages resulting from improper use.
- Use genuine parts only for repair.
- Ensure stability of the ceiling and fastening elements.

Operation of the luminaire

- Exceeding the permissible ambient temperature will reduce the luminaire's lifecycle, resulting in premature failure in extreme cases.
- Avoid ESD problems by not routing feed-through wiring directly along the wiring of the luminaire.
- Connect control inputs of dimmable luminaires with standard cables suitable for power supply voltage.

Manipulation of our products is not permitted

Modifications, reworking, re-labelling of products as well as their package is not permitted and infringes, amongst others, our registered trademark rights. Such modifications may affect technical properties of our products, damage them and possibly cause consequential damage to other objects. The manufacturer shall not be responsible under any circumstances for damage caused by such modifications.



DIN EN IEC 61340-5-1

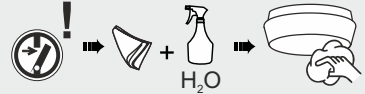

Bei Fragen zu unseren Symbolen, besuchen Sie folgende Webseite:

If you have any questions about our signs, visit the following website:



www.rzb.de/fileadmin/assets/downloads/PDF/RZB_Symbolklaerung.pdf



Stecker / Plug	Pendelmontage / Pendant mounting	Einspeisung Mitte / Feed in the middle
Buchse / Socket	Deckenmontage / Ceiling mounting	Einspeisung Mitte / Feed in the middle
Pendelmontage / Pendant mounting	Einspeisung Anfang von oben / Feed beginning from above	Deckenmontage / Ceiling mounting
Deckenmontage / Ceiling mounting	Einspeisung Anfang von oben / Feed beginning from above	Pendelmontage / Pendant mounting
Verdrahtung anpassen / Adapt wiring	Einspeisung Anfang seitlich / Feed beginning from the side	Deckenmontage / Ceiling mounting
Werkseinstellungen / Factory setting	Einspeisung Anfang seitlich / Feed beginning from the side	Pendelmontage / Pendant mounting
	L-Verbinder / L-Connector	Deckenmontage / Ceiling mounting
	L-Verbinder / L-Connector	Pendelmontage / Pendant mounting
	X,T-Verbinder / X,T-Connector	Deckenmontage / Ceiling mounting
	X,T-Verbinder / X,T-Connector	Pendelmontage / Pendant mounting



Verdrahtung / wiring		I max.	7x	14x
L1	Phase 1 /phase 1	16 A		
L2	Phase 2 /phase 2	16 A		
L3	Phase 3 /phase 3	16 A		
	Schutzleiter / Protective conductor			
N	Neutraleiter /Neutral conductor			
D1	DALI DA /DALI DA			
D2	DALI DA /DALI DA			
1	Notbeleuchtung Kreis 1 /emergency lighting circle 1 (L / L+)	6 A		
2	Notbeleuchtung Kreis 1 /emergency lighting circle 1 (N / N/-)	6 A		
3	Steuer oder geschaltetes Signal / Control or switched signal L (SE)	6 A		
4	Schutzleiter / Protective conductor			
5	Steuer oder geschaltetes Signal / Control or switched signal N (SE)	6 A		
6	Notbeleuchtung Kreis 2 /emergency lighting circle 2 (L / L+)	6 A		
7	Notbeleuchtung Kreis 2 /emergency lighting circle 2 (N / N/-)	6 A		

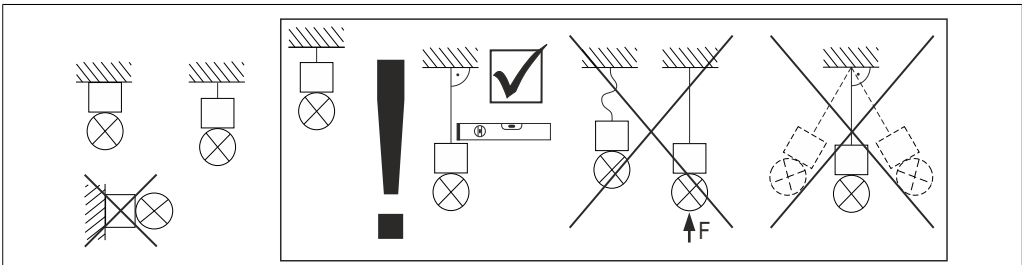
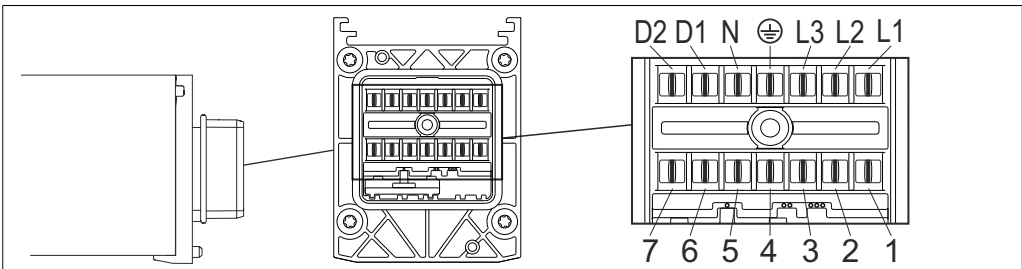
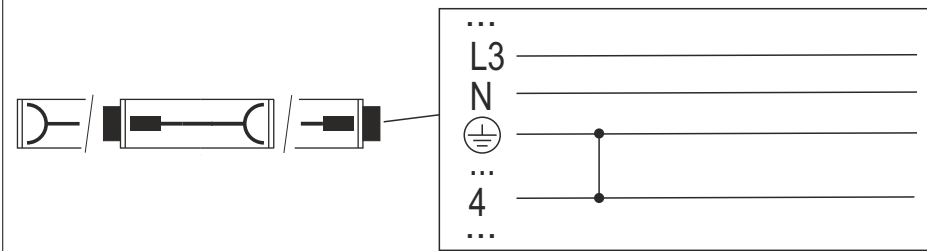

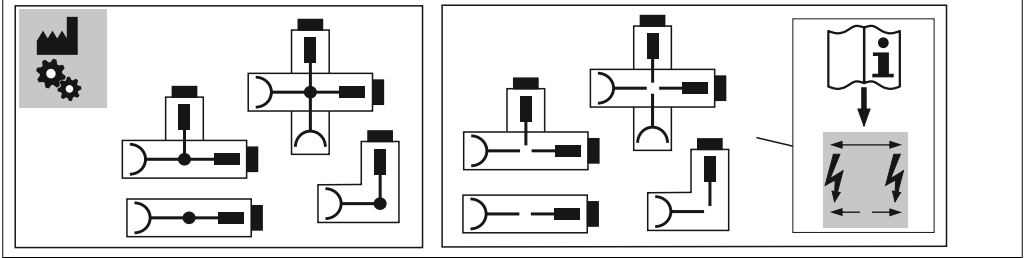
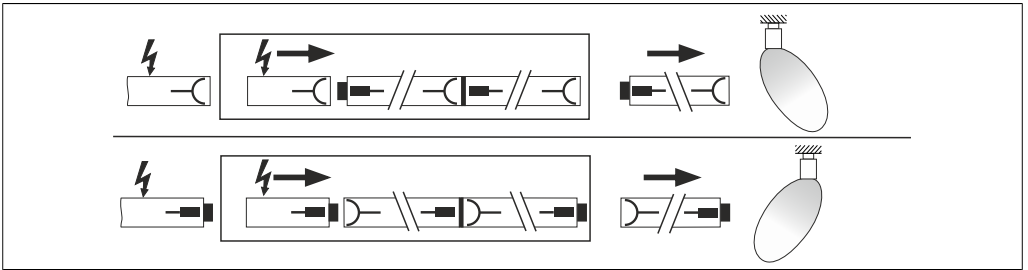
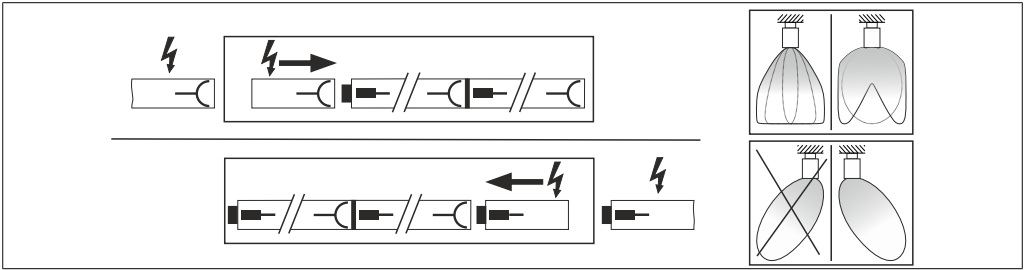

1

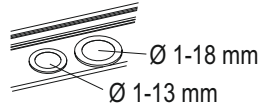
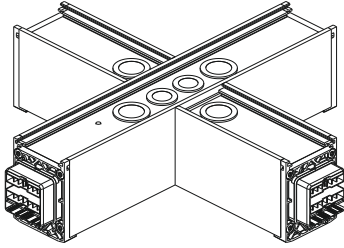

4x- Ø 9-17 mm

2x- Ø 6-13 mm



2

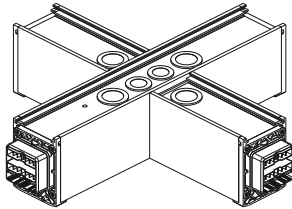

982775.00X



982775.00X.1



3

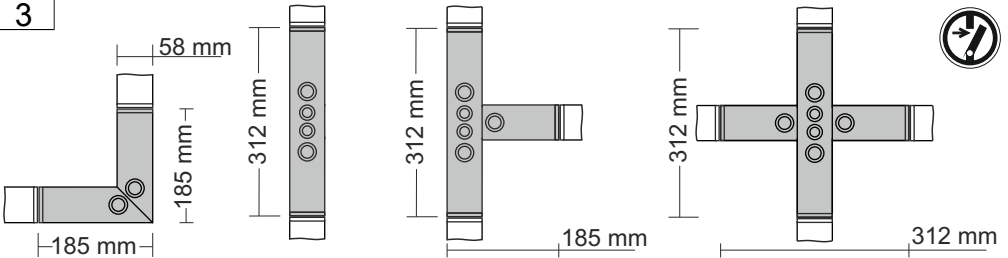

4a

	L	X*
	≤ 4500 mm	≤ 60000 mm
	≤ 2270 mm	≤ 50000 mm

* R_{PE} < 0,5 Ω
EN 60598

! 1x
≤ 12 kg

A ≤ 500 mm

4b

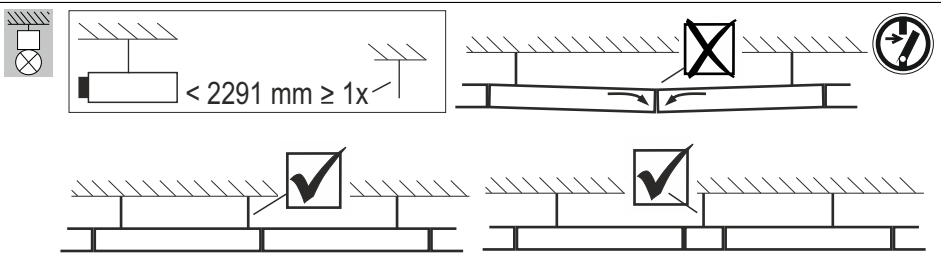

4c

	L	X*
4547 mm	≤ 2200 mm	≤ 60000 mm
2291 mm	≤ 1100 mm	≤ 50000 mm

* $R_{PE} < 0,5 \Omega$
EN 60598

4d

$< 2291 \text{ mm} \geq 1x$

5

6

$M = 2 \text{ Nm}$

7

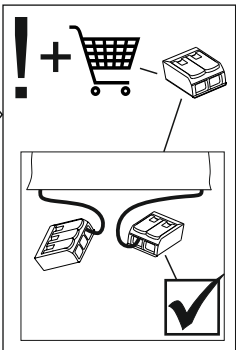
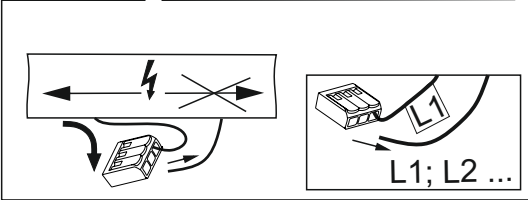
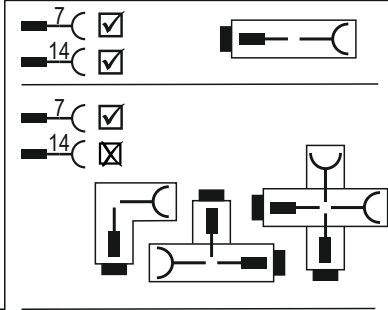
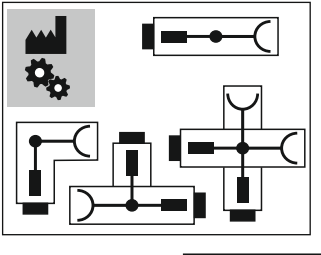

8

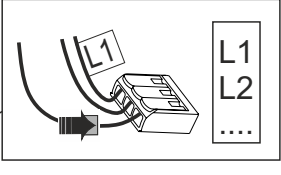
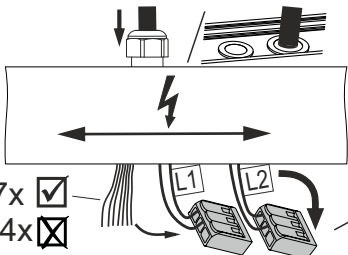
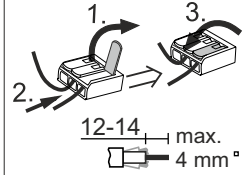

9a

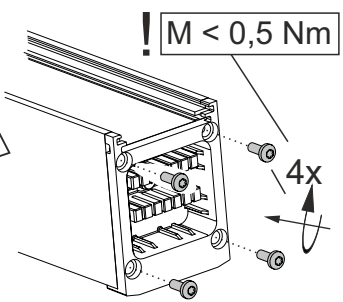
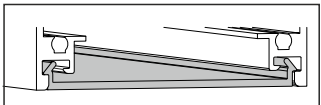
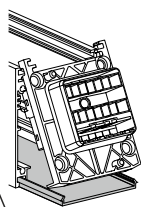
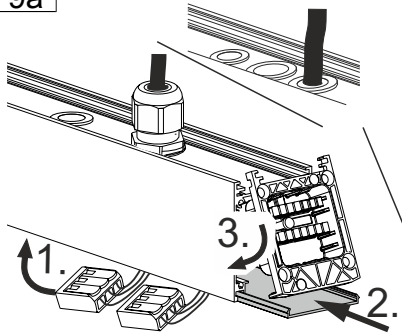

9b

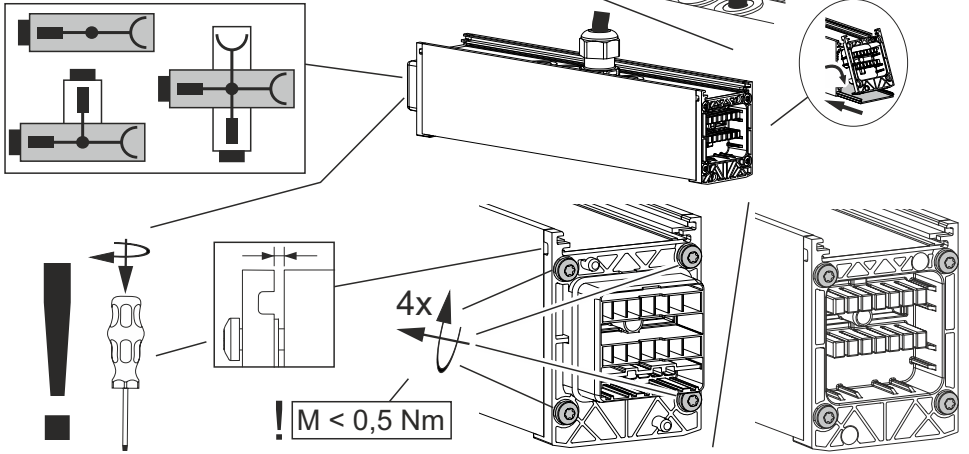

10a

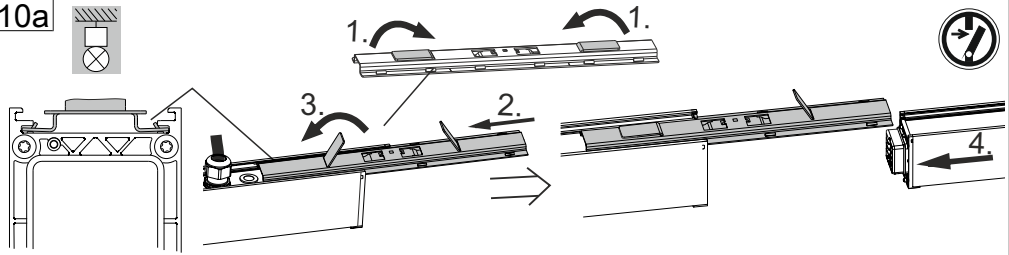

10b

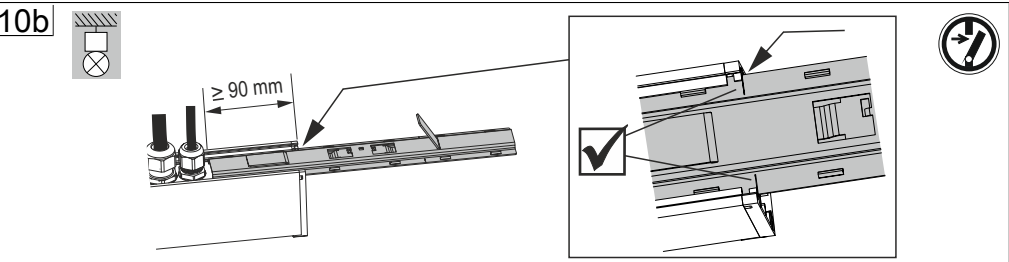

10c

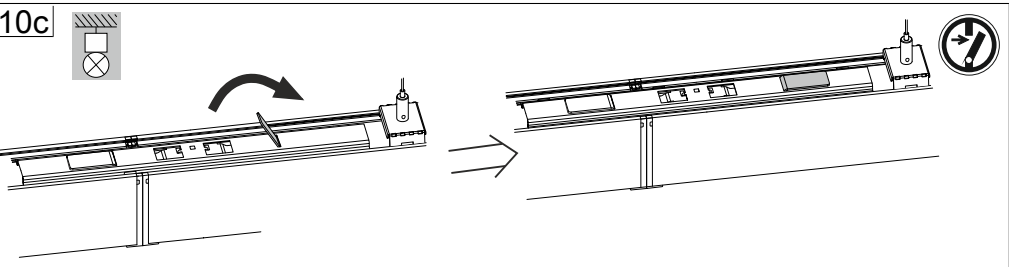

11

$M = 2 \text{ Nm}$

12a

4547 mm $\geq 2x$

< 2291 mm $\geq 1x$

12b

$\text{Ø}6$

10 mm

1. 2. 3.

12c

24 mm

1. 2. 3.

12d

2x



RZB - Rudolf Zimmermann, Bamberg GmbH

 Rheinstraße 16, 96052 Bamberg

 0951/7909-0

 0951/7909-198

 info@rzb-leuchten.de