



 **Made in  
GERMANY**

# POWERTUBE II

360° LARGE AREA LIGHTING

# POWERTUBE II

Portable lighting for large areas



## 360° LIGHT WHEREVER YOU NEED IT

POWERTUBE II is the evolution of our mobile LED large-surface luminaires for discerning customers. There's simply no alternative when you're looking for quickly available, uniform and powerful light. The POWERTUBE II is your ideal all-round companion for building sites, events or sport fixtures. Thanks to improved temperature management and more efficient LEDs, we have managed to more than double the light output. The large version now offers 41,500 lumens, the smaller one 20,000 lumens. Thanks to the newly developed integrated fixture featuring a 30 mm DIN pivot joint, the luminaire can be attached to all tripods, making additional adapters unnecessary. Like before, the POWERTUBE II comes in three versions: with a toggle switch and two light levels, with a dimmable button, and as a networked Casambi Bluetooth® module.

## ADDITIONAL ADVANTAGES

- ⊕ Quick mounting and dismantling without cooling-down time
- ⊕ Harmonious, glare-reduced illumination thanks to opal diffuser and SMD LED panels
- ⊕ Maintenance-free (passive cooling)
- ⊕ Suitable for wind loads up to 150 km / h thanks to cylindrical shape and reinforced tripod adapter
- ⊕ Easy tripod connection thanks to integrated mounting for DIN spigot (30 mm / DIN 14640)
- ⊕ Environmentally friendly and conserves resources thanks to replaceable components

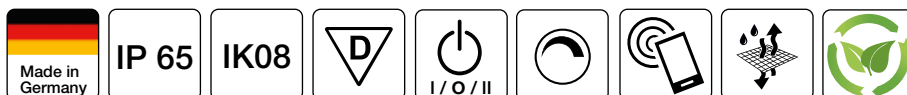



## POSSIBLE APPLICATIONS

- + Building trade
- + Industry
- + Emergency and rescue services  
(technical relief services, police, fire service,  
Red Cross, etc.)
- + Event management



# POWERTUBE II

## Features

Luminaire tested for use with limited surface temperature according to DIN EN 60598-2-24

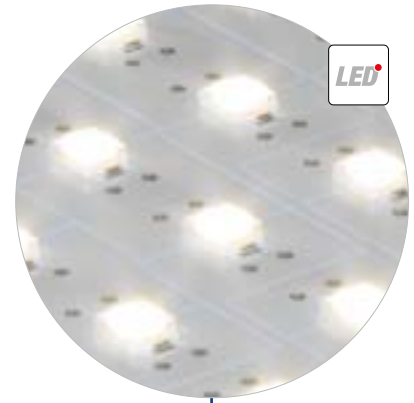

LED panel with high efficiency SMD-LEDs  
**140 lm / W**

Glare-reduced light thanks to opal cover lens made of impact-resistant and non-yellowing polycarbonate

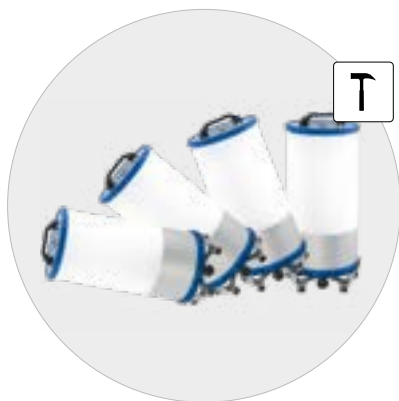

Impact-resistant and break-proof 2-component housing with edge protection of soft thermoplastic elastomer (TPE)



High degree of protection IP 65



Environmentally friendly and onserves resources thanks to replaceable omponents



Integrated handle



### How passive cooling works

In our passively cooled lighting fixtures, the heat inside the fixture is dissipated via an aluminium element, thus obviating the need for active cooling and rendering the lighting fixtures maintenance-free.

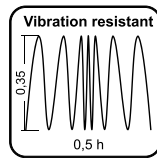
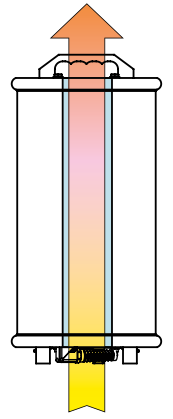

**DUSTPROOF**  
as per  
DIN EN 60598-1  
DIN EN 60529

**VIBRATION RESISTANT**  
as per  
DIN EN 60598-1

Versions with Casambi Bluetooth® control for wireless networking available

Changeover switch  
(OFF, 100%, 50%,  
and continuously dimmable)

Alternative plug systems and  
power cable lengths on request

Wide range of accessories

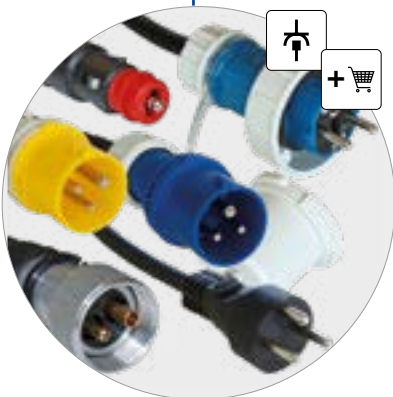

Integrated tripod mount for DIN pin  
(30 mm/DIN 14640)

Pressure compensating valve  
against the formation of condensation  
water in the luminaire

Safe, stable stand  
due to rubber feet





## POWERTUBE II S

Protective tube plastic (polycarbonate, satin), edge protection (silicone rubber, blue), housing cover and base aluminium, 5 m power supply cable with mains plug, incl. carrier bag.

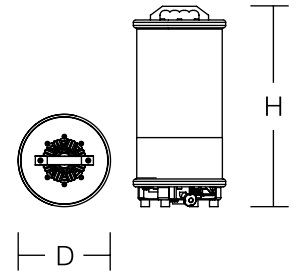

D 270, H 590 mm

- 9.500 lm ..... effective
- 12.750 lm  
5.000 K,  $R_a \geq 80$   
..... 8 x LED panel
- 5 m, H07RN-F  
..... black
- ..... IK08

	<b>P</b>					
<b>230 V, 50-60 Hz</b>						
73P01000-0006.E	90 W	✓	II	IP 65	E+F	9,4 kg
73P01001-0006.E	90 W	✓	II	IP 65	E+F <sup>88</sup>	9,7 kg
73P010CH-0006.E	90 W	✓	II	IP 65	C	9,4 kg
<b>42 V, 50-60 Hz</b>						
73P61060-0006.E	90 W	✓	III	IP 65	CEE	9,4 kg
<b>24 V, 50-60 Hz</b>						
73P51050-0006.E	90 W	✓	III	IP 65	CEE	9,4 kg



## POWERTUBE II M

Protective tube plastic (polycarbonate, satin), edge protection (silicone rubber, blue), housing cover and base aluminium, 5 m power supply cable H07RN-F with mains plug, incl. carrier bag. Dimmable version: with push-button (I / O and dimmable 1 - 100%), 7.5 m supply cable H07BQ-F yellow, incl. mains plug and carrier bag.

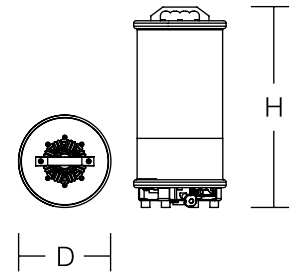

D 270, H 590 mm

- 20.000 lm ..... effective
- 28.100 lm  
5.000 K,  $R_a \geq 80$   
..... 8 x LED panel
- 5 m, H07RN-F, black/  
.... 7,5 m, H07BQ-F, yellow (.P)
- ..... IK08

	<b>P</b>						
<b>230 V, 50-60 Hz</b>							
73P01000-0006	200 W	-	✓	II	IP 65	E+F	9,7 kg
73P01001-0006	200 W	-	✓	II	IP 65	E+F <sup>88</sup>	10,0 kg
73P010CH-0006	200 W	-	✓	II	IP 65	C	9,7 kg
<b>230 V, 0 / 50 / 60 Hz</b>							
73P01000-0006.P	200 W	1 ... 100%	-	II	IP 65	E+F	10,2 kg
73P01001-0006.P	200 W	1 ... 100%	-	II	IP 65	E+F <sup>88</sup>	10,4 kg

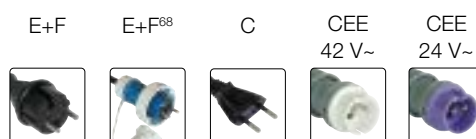

**POWERTUBE II L**

Protective tube plastic (polycarbonate, satin), edge protection (silicone rubber, blue), housing cover and base aluminium, 5 m power supply cable H07RN-F with mains plug, incl. carrier bag. Dimmable version: with push-button (I / O and dimmable 1 - 100%), 7.5 m supply cable H07BQ-F yellow, incl. mains plug and carrier bag.

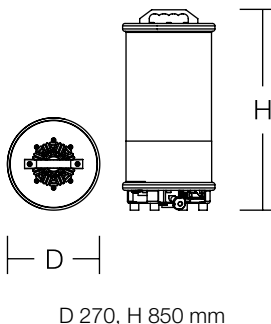

	$\Phi_v$	P						
<b>230 V, 50-60 Hz</b>								
73P03000-0006	41.500 lm	400 W	-	✓	II	IP 65	E+F	13,4 kg
73P03001-0006	41.500 lm	400 W	-	✓	II	IP 65	E+F <sup>68</sup>	13,7 kg
73P030CH-0006	41.500 lm	400 W	-	✓	II	IP 65	C	13,4 kg
<b>230 V, 0 / 50 / 60 Hz</b>								
73P03000-0006.P	41.500 lm	400 W	1 ... 100 %	-	II	IP 65	E+F	14,0 kg
73P03001-0006.P	41.500 lm	400 W	1 ... 100 %	-	II	IP 65	E+F <sup>68</sup>	14,1 kg
<b>42 V, 50-60 Hz</b>								
73P63060-0006.E	19.100 lm	180 W	-	✓	III	IP 65	CEE	13,99 kg
<b>24 V, 50-60 Hz</b>								
73P53050-0006.E	19.100 lm	180 W	-	✓	III	IP 65	CEE	13,99 kg

- $\Phi_v$  41.500 lm | 19.100 lm effective
- 55.450 lm | 25.250 lm  
5.000 K, R<sub>a</sub> ≥ 80  
16 x LED panel
- 5 m, H07RN-F, black / ... 7,5 m, H07BQ-F, yellow (.P)
- IK08

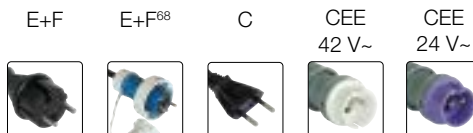
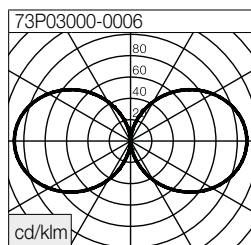

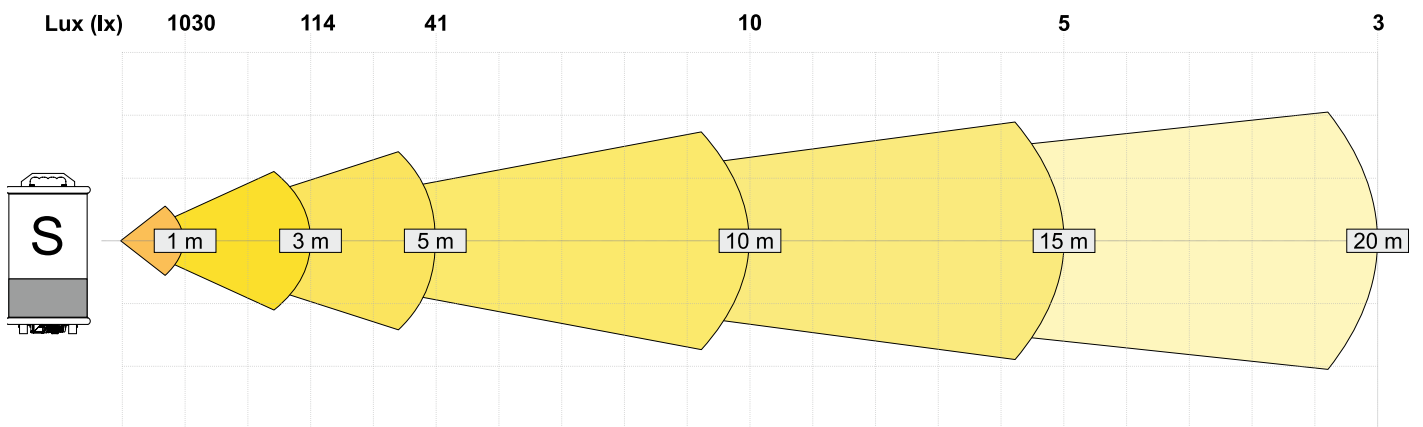
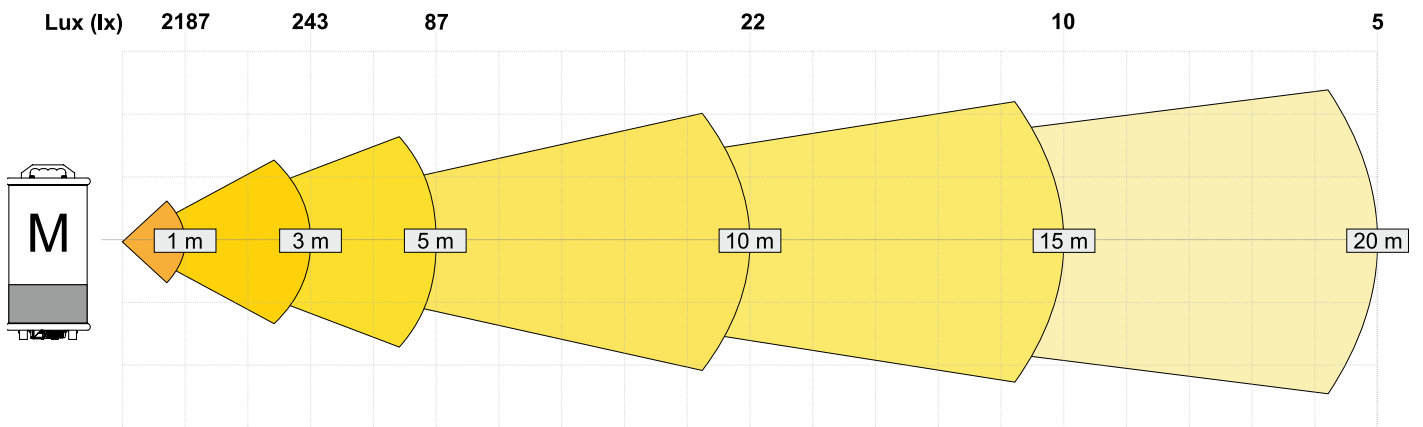
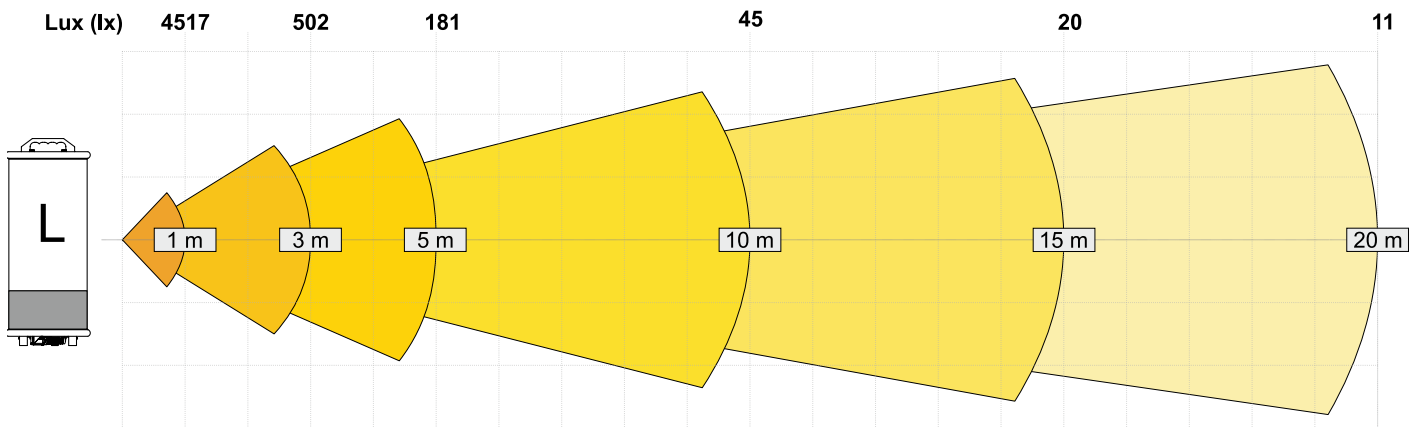







## POWERTUBE II M SC

Protective tube plastic (polycarbonate, satin), edge protection (silicone rubber, blue), housing cover and base aluminium, Bluetooth control module (Casambi), 5 m power supply cable with mains plug, incl. carrier bag.

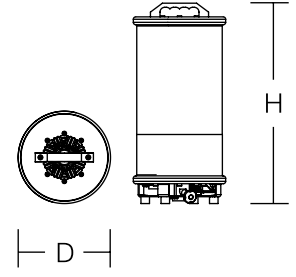

D 270, H 590 mm

$\Phi_v$  ..... 20.000 lm effective

..... 28.100 lm  
5.000 K,  $R_a \geq 80$   
LED panel

..... 5 m, H07BQ-F  
yellow

$T$  ..... IK08



230 V, 50 - 60 Hz

73P01000-0006.PB	8 x LED	200 W	1 ... 100 %	II	IP 65	E+F	9,6 kg
73P01001-0006.PB	8 x LED	200 W	1 ... 100 %	II	IP 65	E+F <sup>68</sup>	9,8 kg

E+F      E+F<sup>68</sup>

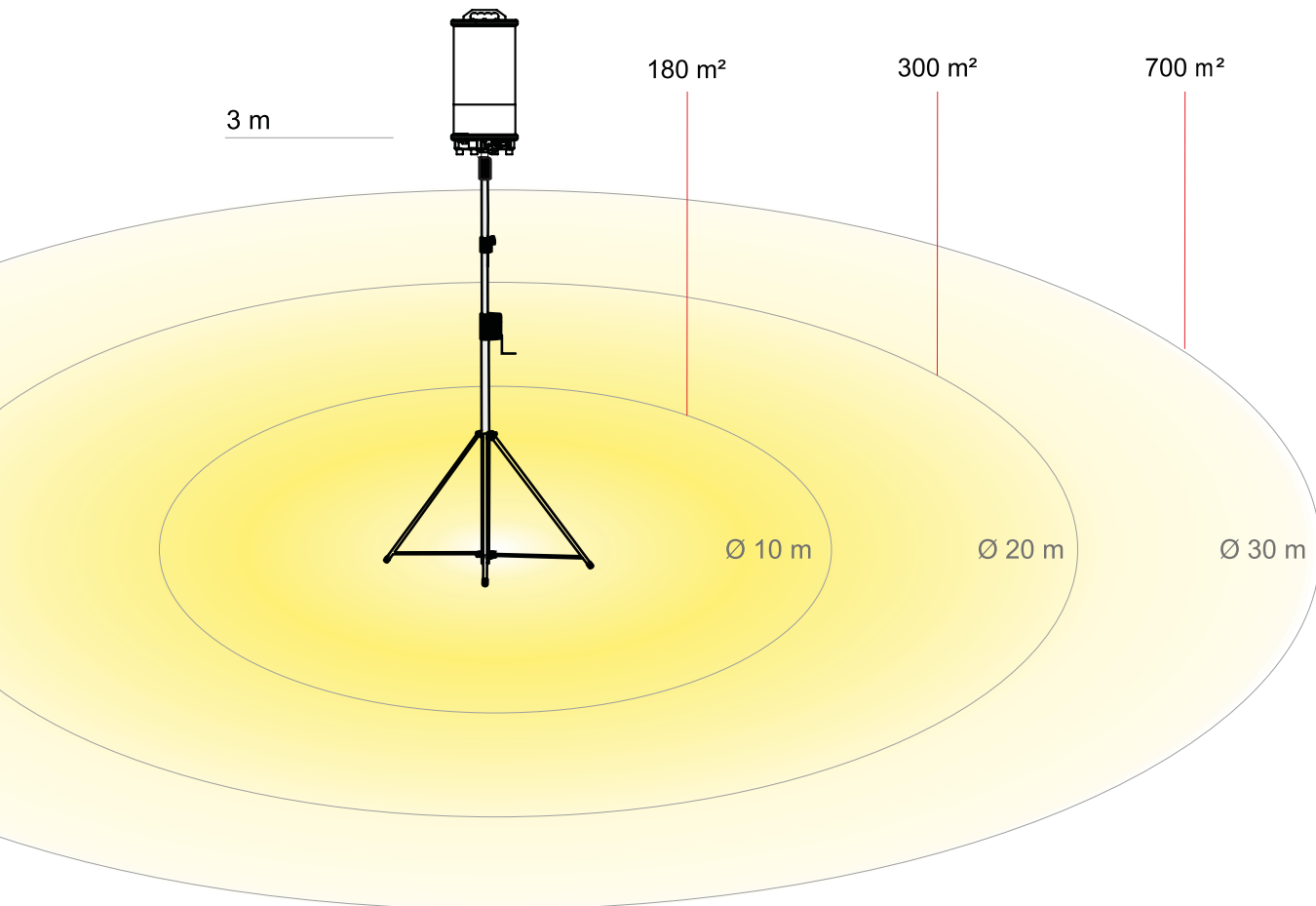
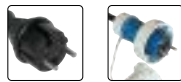

**POWERTUBE II L SC**

Protective tube plastic (polycarbonate, satin), edge protection (silicone rubber, blue), housing cover and base aluminium, Bluetooth control module (Casambi), 5 m power supply cable with mains plug, incl. carrier bag.

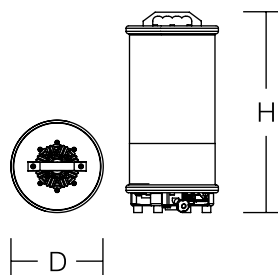

D 270, H 850 mm



230 V, 50 - 60 Hz

73P03000-0006.PB	16 x LED	400 W	1 ... 100%	II	IP 65	E+F	13,4 kg
73P03001-0006.PB	16 x LED	400 W	1 ... 100%	II	IP 65	E+F <sup>68</sup>	13,5 kg

$\Phi_V$  ..... 41.500 lm effective

..... 55.450 lm  
5.000 K, Ra ≥ 80  
..... LED panel

..... 5 m, H07BQ-F yellow

..... IK08

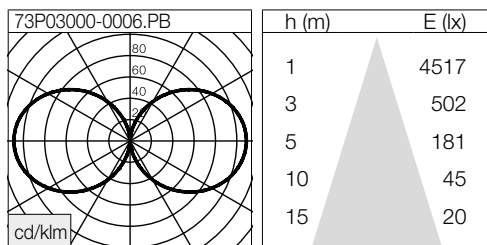

**Smart Control**

Smart Control stands for the intelligent remote control of our luminaires via mobile app from a mobile phone or tablet. It doesn't matter whether individual luminaires or groups of luminaires are to be controlled. All luminaires - even existing ones - can be controlled together with an integrated „Casambi“ module. Thus also our POWERTUBE II, POWERDISK and POWERCASE L. The luminaires are networked via Bluetooth from the mobile device to the luminaire and from luminaire to luminaire, which considerably increases the range of the luminaire network.

- ON/OFF
- Dimming
- Timer
- Scenes
- Animations



## Accessories

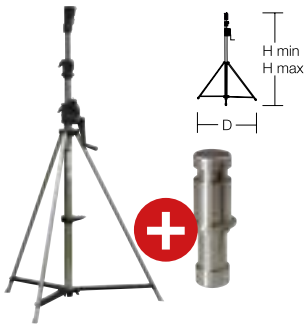

### Crank tripod "Premium"

Steel, chrome plated, suitable for 16 & 28 mm spigots, safety bolt, self braking clutch/winch, fold-away crank, one adjustable stand to compensate uneven terrain

**incl. tripod adapter** 28 mm/30 mm (DIN 14640)

Packed dimensions:  
L 1.850, B 230, H 160 mm

95-0060-0014.D H max 3800, H min 1740, D 1300 mm 22,5 kg



### Crank tripod „LightmaXX“

Galvanised steel, chrome-plated and powder-coated, with spigot adapter, automatic safety lock, 1 foot adjustable for levelling on uneven ground, self-braking coupling, fold-away elevator

**incl. tripod adapter** 28 mm/30 mm (DIN 14640)

**incl. clamping kit for tripod**

Pack dimensions:  
L 1.810, B 300, H 250 mm

95-0294-0014 H max 4130, H min 1750, D 1730 mm 25,0 kg



### Hinged feet with rubber pad

For crank tripod "Premium", stainless steel, Set (3 pieces)



95-0266-0001 0,43 kg



### Bracing set

3 x rope cord and peg

95-0267-0001 1,1 kg

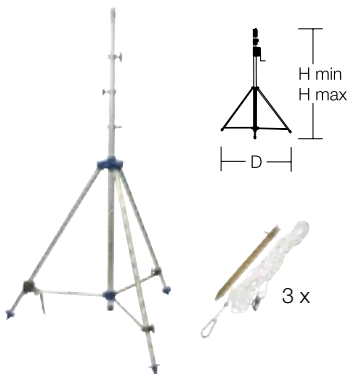

### Tripod "Professionell"

Stainless steel, air-cushioned for safe and comfortable operation, adjustable stand to compensate uneven terrain, with standard spigot 30 mm (DIN 14640), including bracing set (3 x rope cord and peg)

Packed dimensions:  
L 1.120, B 200, H 200 mm

95-024 H max 4450, H min 1100, D 1600 mm 13,3 kg



### Belt strap incl. snap hook

For suspended mounting of POWERTUBE II



95-0225-0001 L 350 mm 0,05 kg







---

---

---

---

---

---

---

---

---

---

---

---

---

---

---

---

---

---

---

---

---

---

---

---

---

---

---





## Mobiles Licht für Profis – Made in Germany

Portable light for professionals – Made in Germany

*Éclairage mobile pour les professionnels –  
Fabriqué en Allemagne*

SONLUX Lighting GmbH

Frankenhäuser Straße 66  
99706 Sondershausen  
Germany

Phone +49 3632 6522 - 0  
Fax +49 3632 6522 - 822

www.sonlux.de  
info@sonlux.de



### Tip with added value:

The digital version of this publication contains **interactive links** that lead you from the article number directly to the web.



Member of

licht.de