

INSTRUCTION

LINEDO
950663.942.400.200

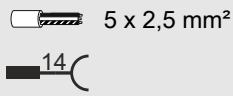

≈ 220 - 240 V 0/50/60 Hz IP 20 IK03



Umgebungstemperatur /
temperature ambiante
=> -25 °C ... + 50 °C

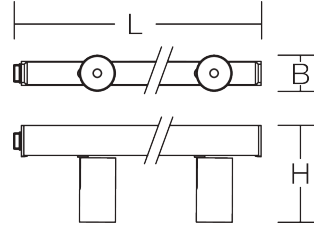

L 598, B 88, H 235

3,07 kg



Φ [lm]

P_{in} [W]

P_{out}

LED

7800

58

2 x 24,8 W

CCT [K]

CRI

RG [St.]

EEK [St.]

4000

92

RG 1

D

I_{max} / $I_{\text{max}}/2$
T50

B10 [St.]

B16 [St.]

C10 [St.]

C16 [St.]

$\cos \varphi$

9 A / 65 μ s

10

17

17

28

0,9

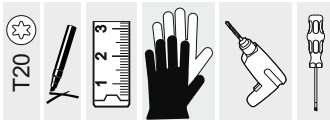



Installation erfordert
Elektro-Fachkraft!
Symbole nach ISO 7010



Allgemeine Sicherheitshinweise

- Der elektrische Anschluss muss ordnungsgemäß nach geltenden Normen und den nationalen sowie internationalen Sicherheits- und Unfallverhütungsvorschriften erfolgen.
- Beschädigte Leuchten dürfen nicht betrieben werden.
- Keine Haftung für Schäden durch unsachgemäßen Einsatz.
- Bei Instandsetzung nur Originalteile verwenden.
- Tragfähigkeit der Decke und Befestigungselemente sicherstellen.

Betrieb der Leuchte

- Die unzulässigen Umgebungstemperaturen reduzieren die Lebensdauer der Leuchte, im Extremfall droht der Frühausfall.
- Zur Vermeidung von EMV-Problemen die Durchgangsverdrahtung nicht entlang der Leuchtenverdrahtung führen.
- Steuereingänge von dimmbaren Leuchten mit handelsüblichen für Netzspannung geeigneten Leitungen anschließen.

Manipulationen unserer Produkte sind unzulässig

Veränderung, Umarbeitung, Umkennzeichnung von Produkten sowie deren Verpackung sind unzulässig und verletzen u.a. unsere eingetragenen Warenzeichenrechte. Solche Modifikationen können technische Eigenschaften unserer Produkte negativ beeinflussen, diese zerstören und möglicherweise Folgeschäden an anderen Objekten verursachen. Für durch derartige Modifikationen verursachte Schäden kann der Hersteller in keinem Fall verantwortlich gemacht werden.



Installation requires
a qualified electrician!
Symbols according
to ISO 7010



General Safety Information

- Electric connection must be appropriate according to all applicable standards and other national and international safety and accident prevention regulations.
- Damaged luminaires must not be operated.
- No liability is accepted for damages resulting from improper use.
- Use genuine parts only for repair.
- Ensure stability of the ceiling and fastening elements.

Operation of the luminaire

- Exceeding the permissible ambient temperature will reduce the luminaire's lifecycle, resulting in premature failure in extreme cases.
- Avoid ESD problems by not routing feed-through wiring directly along the wiring of the luminaire.
- Connect control inputs of dimmable luminaires with standard cables suitable for power supply voltage.

Manipulation of our products is not permitted

Modifications, reworking, re-labelling of products as well as their package is not permitted and infringes, amongst others, our registered trademark rights. Such modifications may affect technical properties of our products, damage them and possibly cause consequential damage to other objects. The manufacturer shall not be responsible under any circumstances for damage caused by such modifications.



 Bei Fragen zu unseren Symbolen, besuchen Sie folgende Webseite:
If you have any questions about our signs, visit the following website:



https://www.rzb.de/fileadmin/assets/downloads/PDF/RZB_Symbolklaerung.pdf

EEK 

Dieses Produkt enthält eine Lichtquelle der Energieeffizienzklasse D entsprechend Verordnung (EU) 2019/2015

This product contains a light source of energy efficiency class D according to regulation (EU) No 2019/2015

 Jede zersprungene Schutzabdeckung ist zu ersetzen. DIN EN 60598

Replace any cracked protective shield. IEC DIN EN 60598

 Die Lichtquelle dieser Leuchte darf nur vom Hersteller oder einem von ihm beauftragten Servicetechniker oder einer vergleichbar qualifizierten Person ersetzt werden. DIN EN 60598-1 / IEC 60598-1

The light source contained in this luminaire shall only be replaced by the manufacturer or his service agent or a similar qualified person. DIN EN 60598-1 / IEC 60598-1



Stecker / Plug	Pendelmontage / Pendant mounting Einspeisung Mitte / Feed in the middle
Buchse / Socket	Deckenmontage / Ceiling mounting Einspeisung Mitte / Feed in the middle
Pendelmontage / Pendant mounting	Pendelmontage / Pendant mounting Einspeisung Anfang von oben / Feed beginning from above
Deckenmontage / Ceiling mounting	Deckenmontage / Ceiling mounting Einspeisung Anfang von oben / Feed beginning from above
Verdrahtung anpassen / Adapt wiring	Pendelmontage / Pendant mounting Einspeisung Anfang seitlich / Feed beginning from the side
Werkseinstellungen / Factory setting	Deckenmontage / Ceiling mounting Einspeisung Anfang seitlich / Feed beginning from the side
	Pendelmontage / Pendant mounting L-Verbinder / L-Connector
	Deckenmontage / Ceiling mounting L-Verbinder / L-Connector
	Deckenmontage / Ceiling mounting X,T-Verbinder / X,T-Connector
	Pendelmontage / Pendant mounting X,T-Verbinder / X,T-Connector

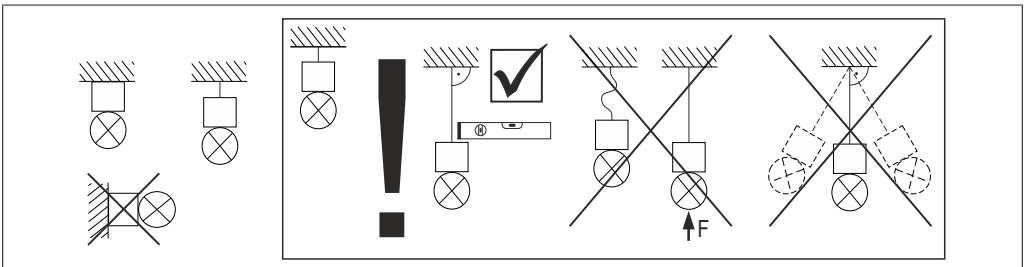

INSTRUCTION

950663.942.400.200

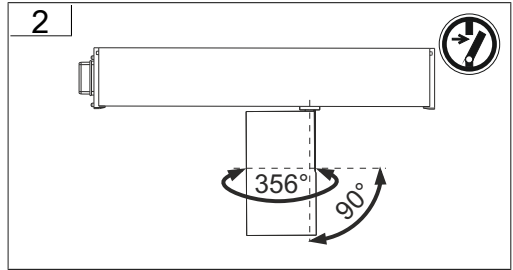
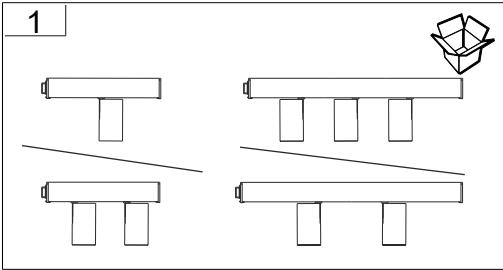
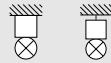

3a

	L	X*
4547 mm	≤ 4500 mm	≤ 60000 mm
2291 mm	≤ 2270 mm	≤ 50000 mm

* R_{PE} < 0,5 Ω
EN 60598

! 1x
≤ 12 kg

3b

	L	X*
4547 mm	≤ 4500 mm	≤ 60000 mm
2291 mm	≤ 2270 mm	≤ 50000 mm

* R_{PE} < 0,5 Ω
EN 60598

! 1x
≤ 12 kg

3c

< 2291 mm ≥ 1x

3d

	L	X*
4547 mm	≤ 4400 mm	≤ 60000 mm
2291 mm	≤ 2100 mm	≤ 50000 mm

* R_{PE} < 0,5 Ω
EN 60598

! 1x
≤ 7 kg

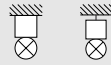

3e

	L	X*
4547 mm	≤ 4400 mm	≤ 60000 mm
2291 mm	≤ 2100 mm	≤ 50000 mm

* $R_{PE} < 0,5 \Omega$
EN 60598

3f

	L	X*
4547 mm	≤ 4400 mm	≤ 60000 mm
2291 mm	≤ 2100 mm	≤ 50000 mm

* $R_{PE} < 0,5 \Omega$
EN 60598

3g

$\geq 2291 \text{ mm} \geq 2x$
 $< 2291 \text{ mm} \geq 1x$

4a

4547 mm
 2291 mm $\geq 2x$
 $< 2291 \text{ mm} \geq 1x$

4b

$\varnothing 6$
 10 mm

1. 2. 3.

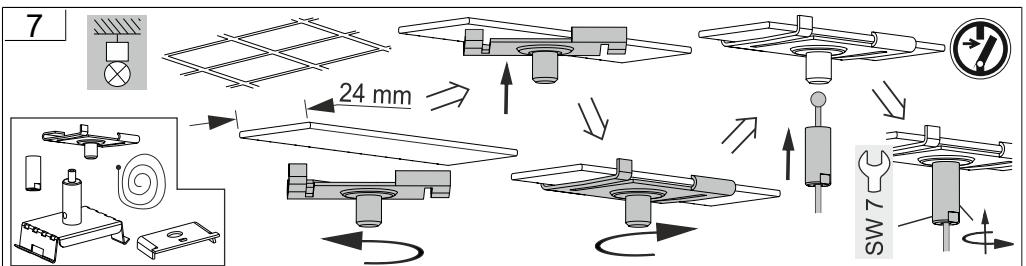
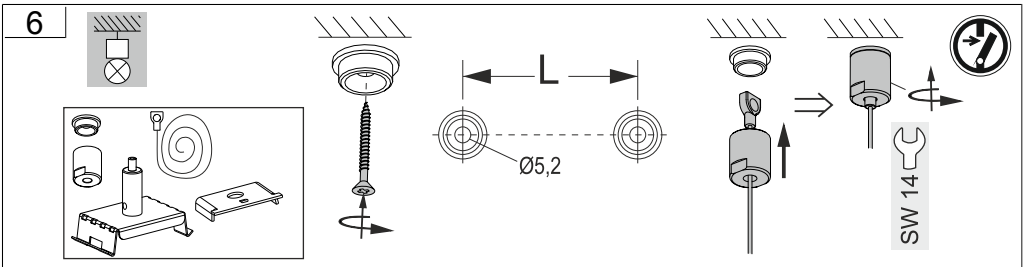
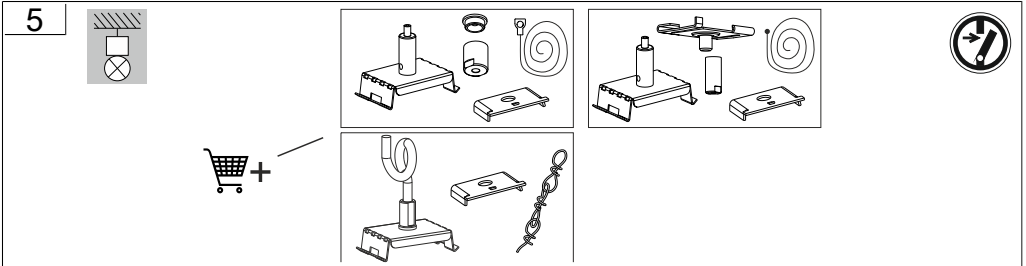
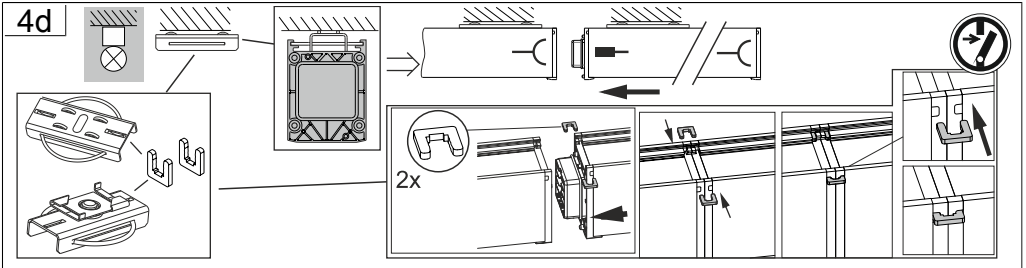
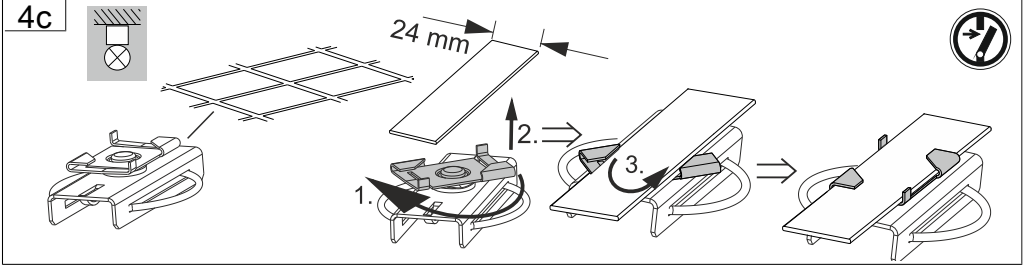
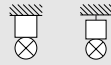



8a

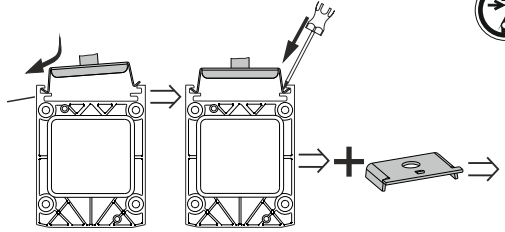
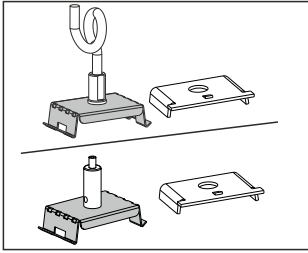

8b

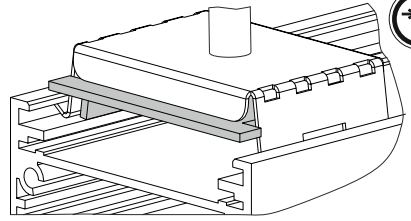
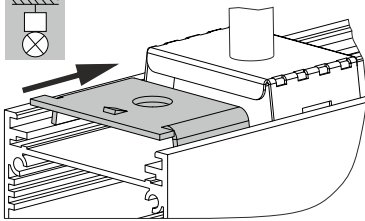

9

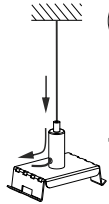
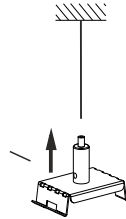
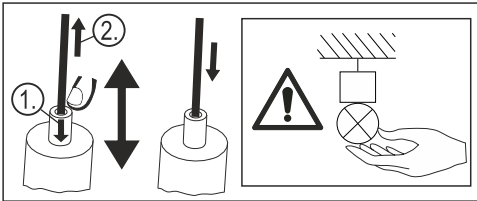
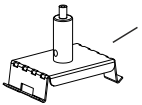

10

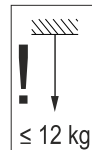
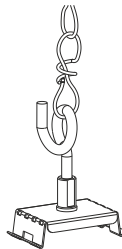
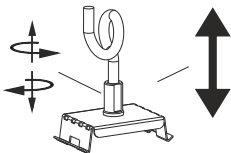



11

Werkseinstellung L1 /
Factory setting L1

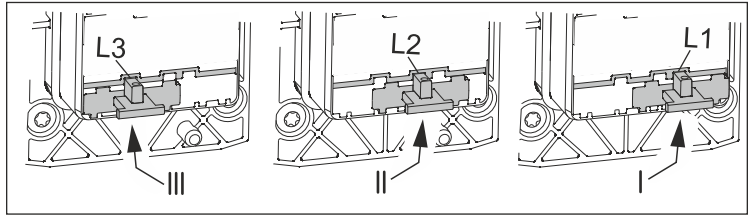
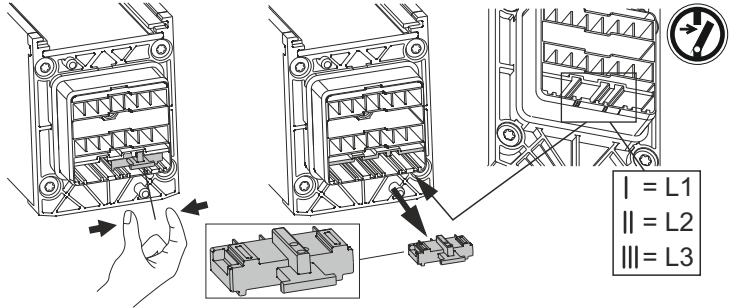
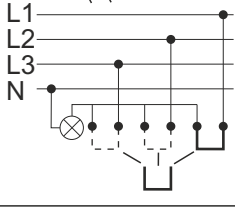

12a

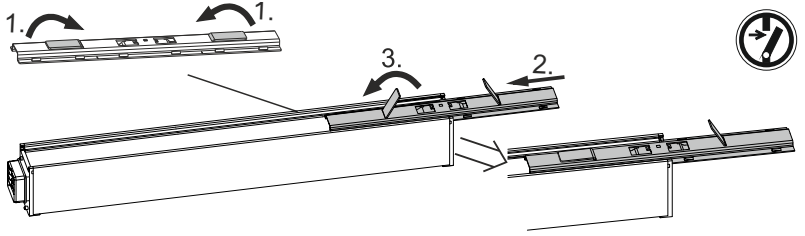

12b

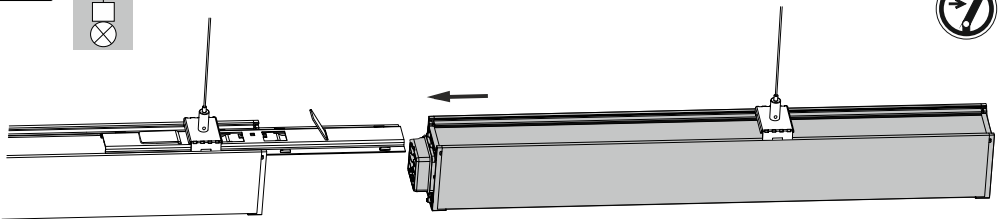

12c

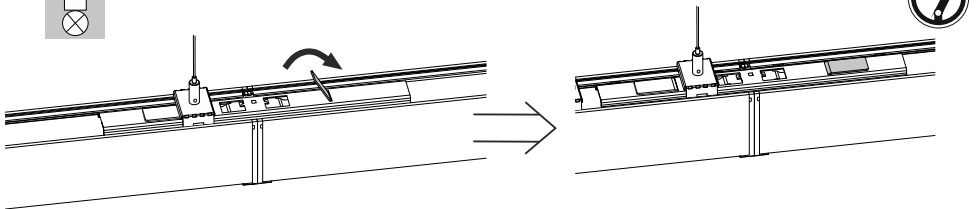

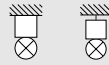

13

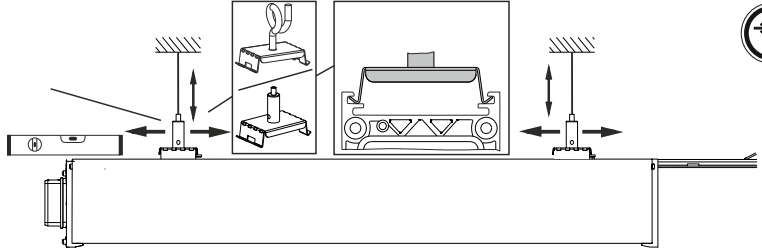

14a

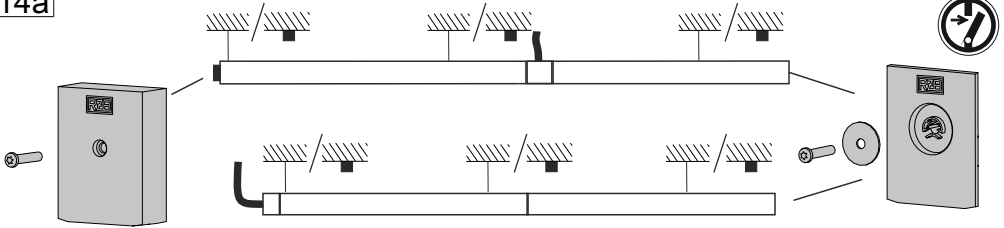

14b

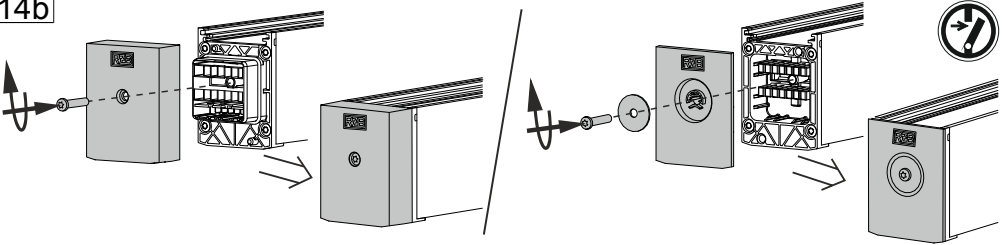

15

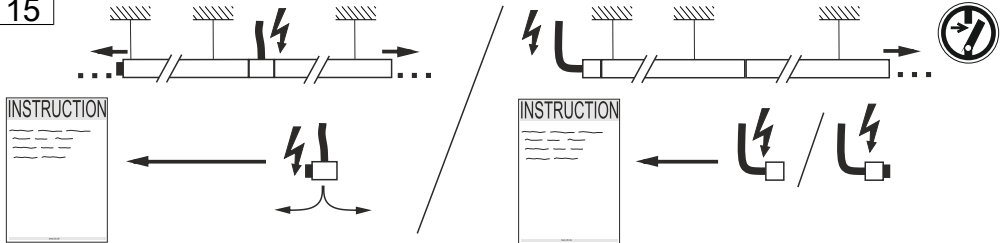

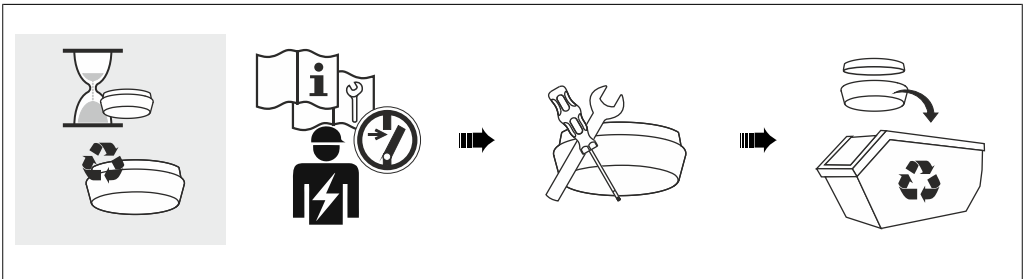
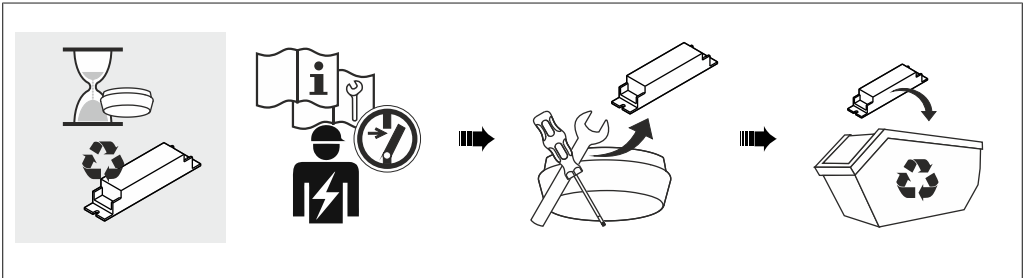
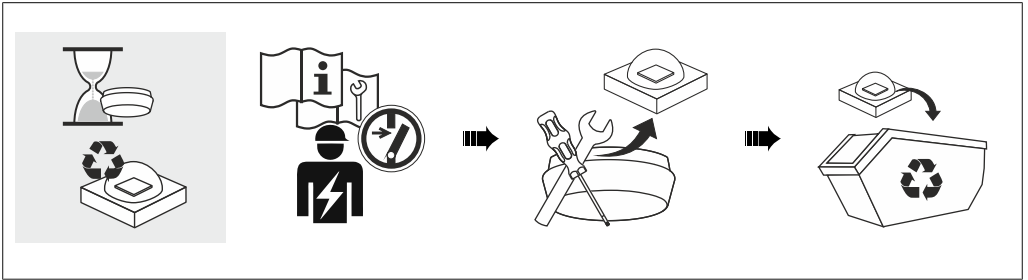









RZB - Rudolf Zimmermann, Bamberg GmbH

 Rheinstraße 16, 96052 Bamberg

 0951/7909-0

 0951/7909-198

 info@rzb-leuchten.de