

INSTRUCTION

Bocaro E Poller
811457

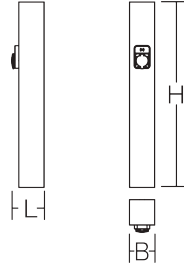

L 200, B 156, H 1150

18,91 kg



5 x 25 mm²



3 x / 50 Hz

IP 54 / IK08



I_{min}

0,25 A



I_{max}

32 A

P [kW]

1 x 22 kW

EN 50470

Class A

$\cos \varphi$

0,90 - 1,00

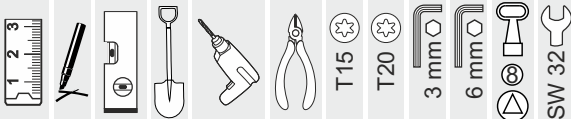



Installation erfordert
Elektro-Fachkraft!

Symbole nach ISO 7010



Allgemeine Sicherheitshinweise

- Der elektrische Anschluss muss ordnungsgemäß nach geltenden Normen und den nationalen sowie internationalen Sicherheits- und Unfallverhütungsvorschriften erfolgen.
- Beschädigte Leuchten dürfen nicht betrieben werden.
- Keine Haftung für Schäden durch unsachgemäßen Einsatz.
- Bei Instandsetzung nur Originalteile verwenden.
- Tragfähigkeit der Decke und Befestigungselemente sicherstellen.

Betrieb der Leuchte

- Die unzulässigen Umgebungstemperaturen reduzieren die Lebensdauer der Leuchte, im Extremfall droht der Frühausfall.
- Zur Vermeidung von EMV-Problemen die Durchgangsverdrahtung nicht entlang der Leuchtenverdrahtung führen.
- Steuereingänge von dimmbaren Leuchten mit handelsüblichen für Netzspannung geeigneten Leitungen anschließen.

Manipulationen unserer Produkte sind unzulässig

Veränderung, Umarbeitung, Umkennzeichnung von Produkten sowie deren Verpackung sind unzulässig und verletzen u.a. unsere eingetragenen Warenzeichenrechte. Solche Modifikationen können technische Eigenschaften unserer Produkte negativ beeinflussen, diese zerstören und möglicherweise Folgeschäden an anderen Objekten verursachen. Für durch derartige Modifikationen verursachte Schäden kann der Hersteller in keinem Fall verantwortlich gemacht werden.



Installation requires
a qualified electrician!

Symbols according
to ISO 7010



General Safety Information

- Electric connection must be appropriate according to all applicable standards and other national and international safety and accident prevention regulations.
- Damaged luminaires must not be operated.
- No liability is accepted for damages resulting from improper use.
- Use genuine parts only for repair.
- Ensure stability of the ceiling and fastening elements.

Operation of the luminaire

- Exceeding the permissible ambient temperature will reduce the luminaire's lifecycle, resulting in premature failure in extreme cases.
- Avoid ESD problems by not routing feed-through wiring directly along the wiring of the luminaire.
- Connect control inputs of dimmable luminaires with standard cables suitable for power supply voltage.

Manipulation of our products is not permitted

Modifications, reworking, re-labelling of products as well as their package is not permitted and infringes, amongst others, our registered trademark rights. Such modifications may affect technical properties of our products, damage them and possibly cause consequential damage to other objects. The manufacturer shall not be responsible under any circumstances for damage caused by such modifications.



DIN EN IEC 61340-5-1

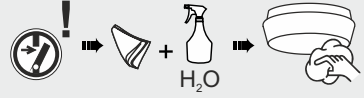

Bei Fragen zu unseren Symbolen, besuchen Sie folgende Webseite:
If you have any questions about our signs, visit the following website:



https://www.rzb.de/fileadmin/assets/downloads/PDF/RZB_Symbolklaerung.pdf

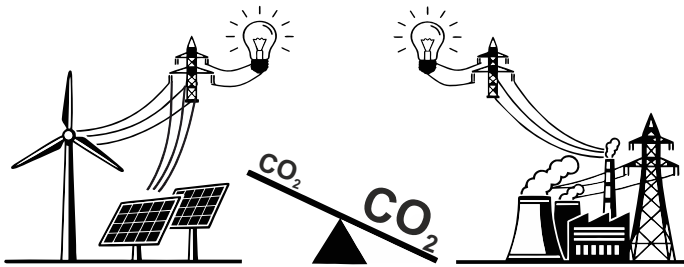



EU-Konformitätserklärung
EU Declaration of Conformity
Déclaration UE de conformité
Declaración UE de conformidad
Deklaracja zgodności UE



Hersteller, Anschrift:
Manufacturer, address:
Fabricant, adresse:
Fabricante, dirección:
Producent, adres:

RZB Rudolf Zimmermann, Bamberg GmbH
Rheinstrasse 16
96052 Bamberg
Deutschland / Germany / Allemagne / Alemania / Niemcy

Wir erklären in alleiniger Verantwortung, dass das Produkt
 We declare under sole responsibility that the product
 Nous déclarons, sous notre propre responsabilité, que le produit
 Declaramos bajo nuestra sola responsabilidad que el producto
 Deklarujemy z pełną odpowiedzialnością, że produkt

Produktbezeichnung:
Product designation:
Description des produits:
Designación de producto:
Oznaczenie produktu:

Bocaro E Poller
811457

mit den folgenden EU-Richtlinien und Normen übereinstimmt:
 complies with the following EU Directives and standards:
 est conforme aux normes et directives de l'UE suivantes:
 cumple con las siguientes directivas y normas CE:
 jest zgodny z następującymi dyrektywami UE i normami:

<p>RED Directive 2014/53/EU</p>	<p>(3.1a) EN 50364:2010 EN 62368-1:2014/AC:2015 EN 62369-1:2014/AC:2015 EN 62479:2010 (3.1b) EN 301 489-1 V2.2.3 EN 301 489-17 V3.2.4 EN 301 489-3 V2.3.2 EN 55032:2015/A11:2020 EN 61000-3-11:2019 EN 61000-3-12:2011 EN 61000-6-2:2019 EN 61000-6-3:2021 (3.2) EN 300 330 V2.1.1</p>
<p>RoHS Directive 2011/65/EU</p>	<p>EN 63000:2018</p>

Dokument-Nr. / Document No. / Document No.
 Document No. / Nr dokumentu

25000484

Aussteller / Issuer / Délivré par:
 Otorgante / Wystawca:

RZB Rudolf Zimmermann, Bamberg GmbH

Ort, Datum / Place, Date / Lieu, date:
 Lugar, Fecha / Miejsce, data:

Bamberg, 25.02.2025

Rechtsverbindliche Unterschrift:
 Legally binding signature:
 Signature juridiquement obligatore:
 Firma legalmente vinculante:
 Prawnie wiązacy podpis:

 Reiner Jürgens
 CEO/Direktor Zarządzający/Geschäftsführer



1

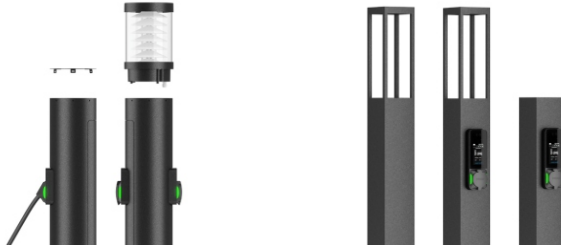

2

a)

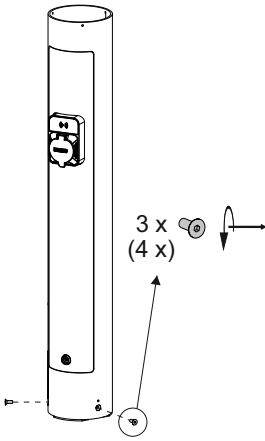

b)

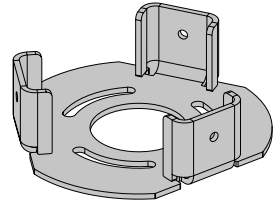
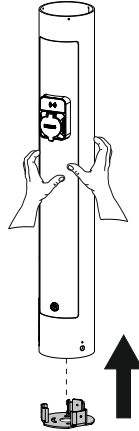

c)

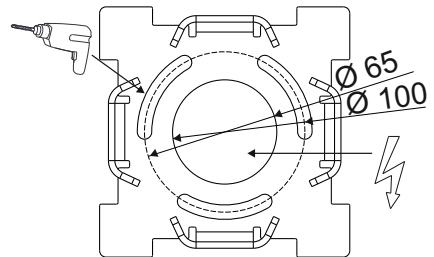
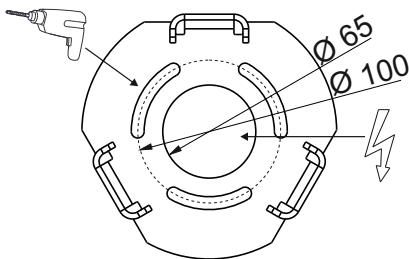



3

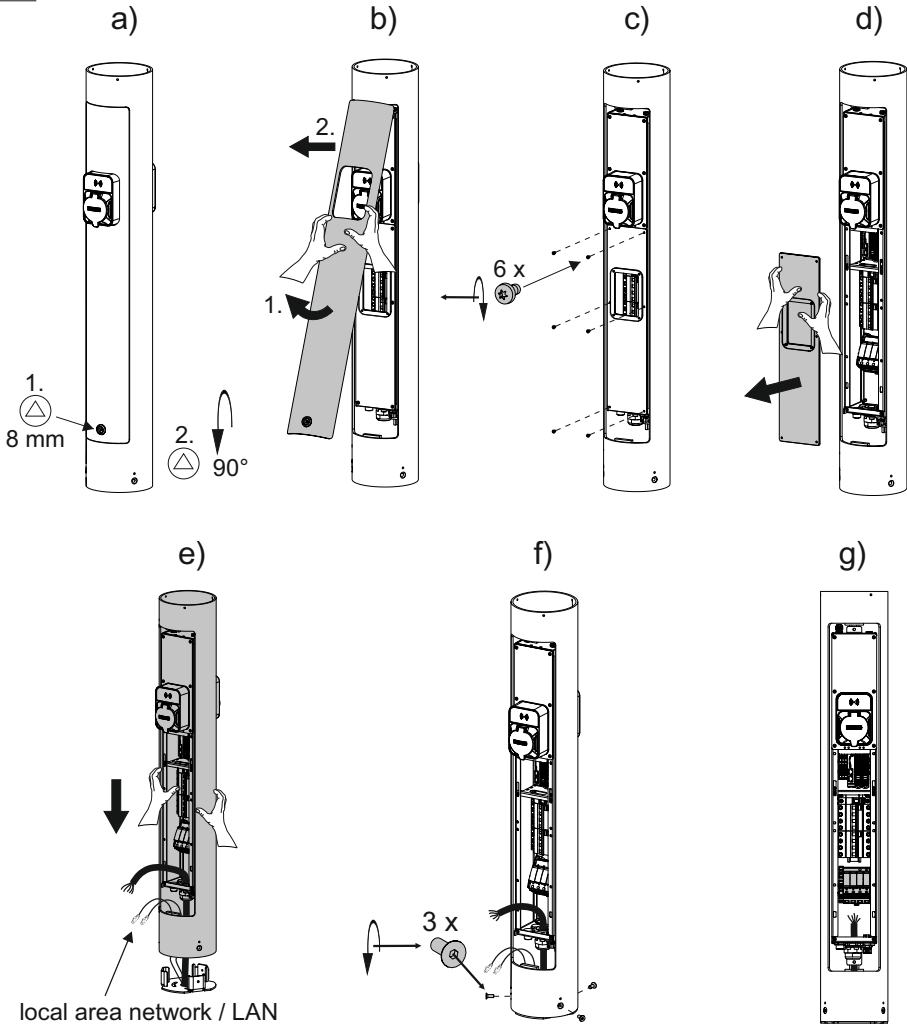



4

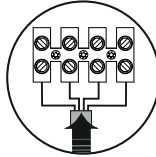
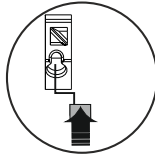
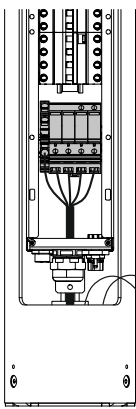

L1 L2 L3 N

L1 = braun / brown
 L2 = schwarz / black
 L3 = grau / grey
 N = blau / blue
 ⊕ = gelb, grün / yellow, green
 local area network / LAN

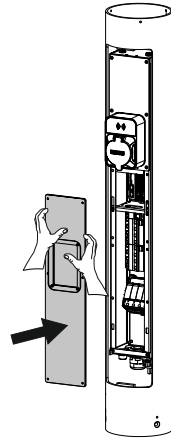



5

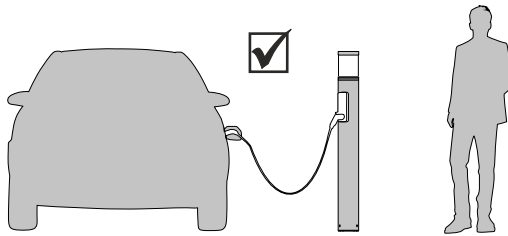
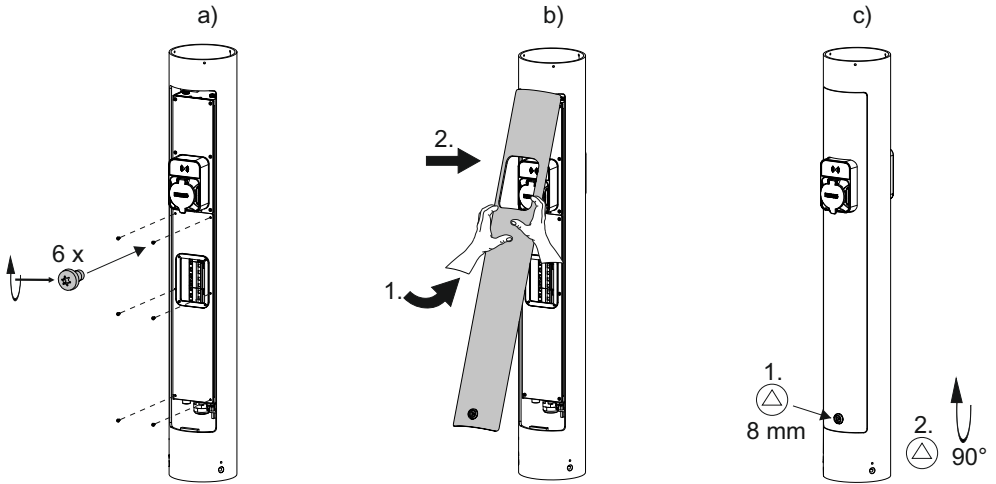



1

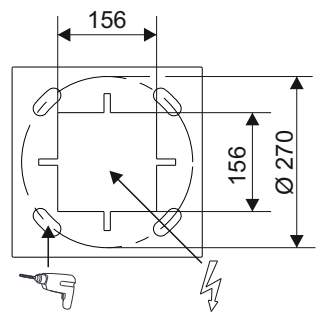
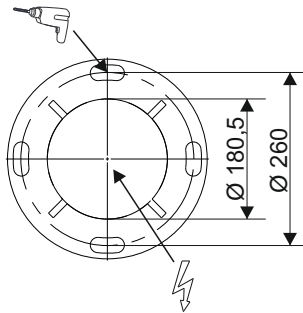
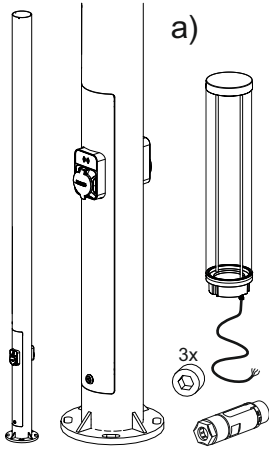

c)

d)

e)

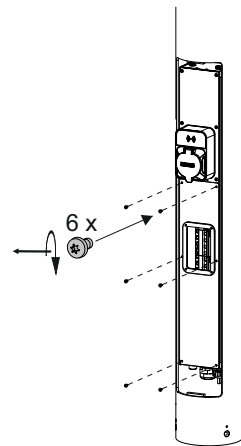
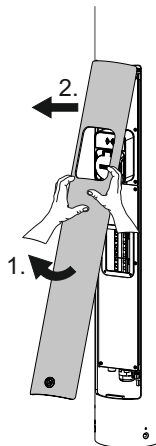
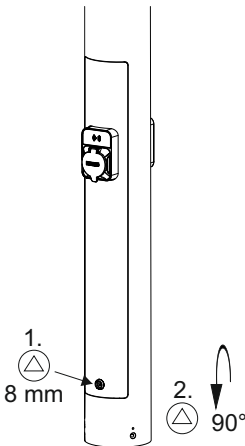



2



a)

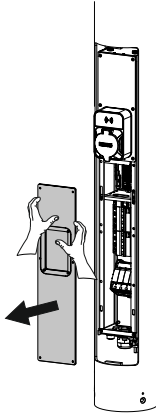

b)

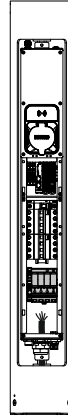

c)

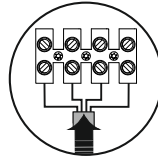
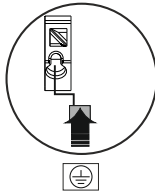
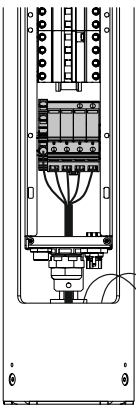

L1 L2 L3 N

- L1 = braun / brown
- L2 = schwarz / black
- L3 = grau / grey
- N = blau / blue
- ⊕ = gelb, grün / yellow, green
- local area network / LAN

d)

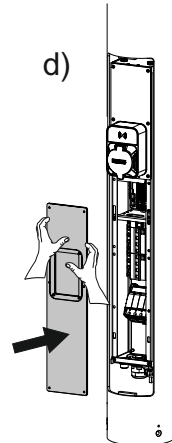

e)

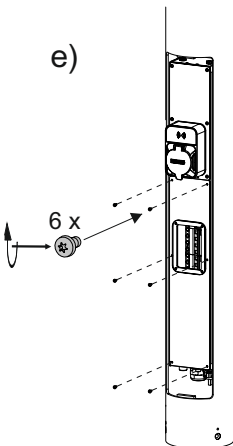

f)

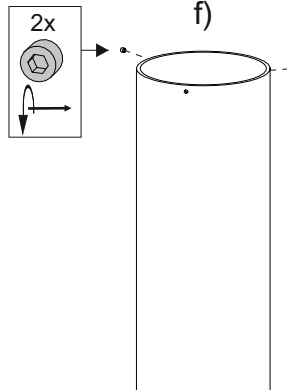

g)

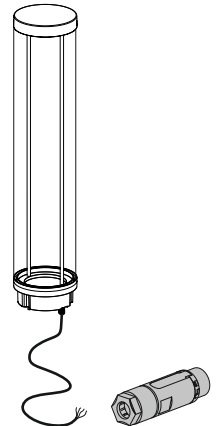



3

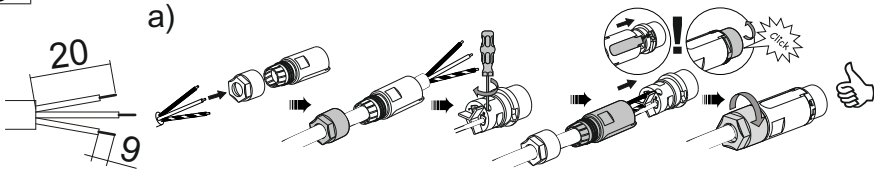

1 = L
2 = N
3 = DA
4 = DA

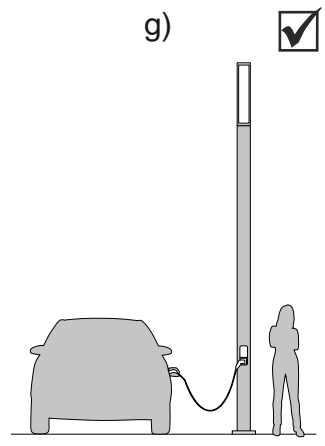
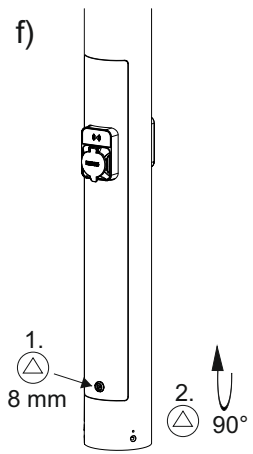
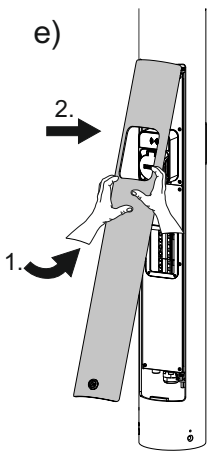
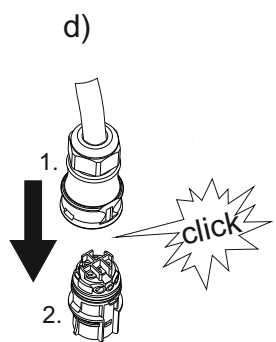
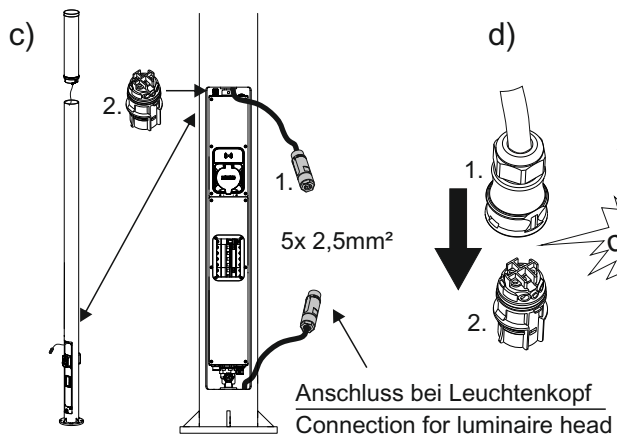
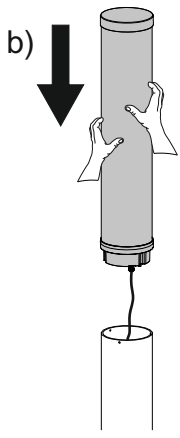
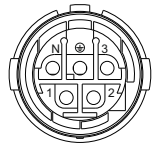



1

a)

+ 983025.0031
983025.004

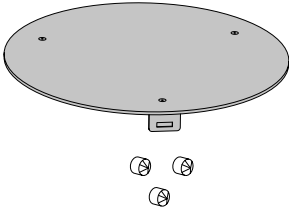

b)

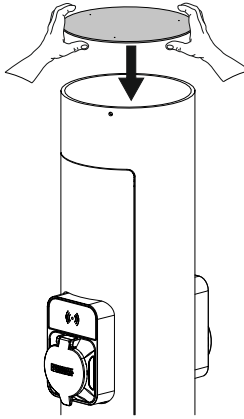

c)

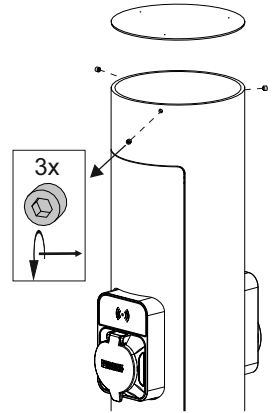

d)



1

982705.0031
982705.004
982705.0031.1
982705.004.1

982705.0131
982705.014
982705.0131.1
982705.014.1



982706.0031
982706.004
982706.0031.1
982706.004.1

982707.0031
982707.004
982707.0031.1
982707.004.1

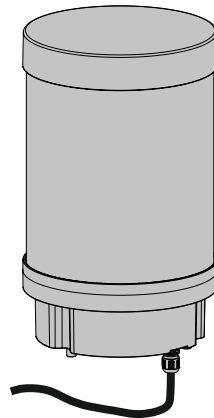



2

a)

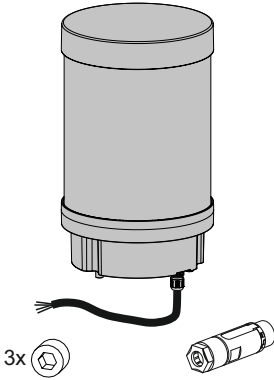

b)

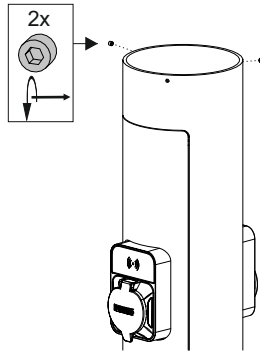

c)

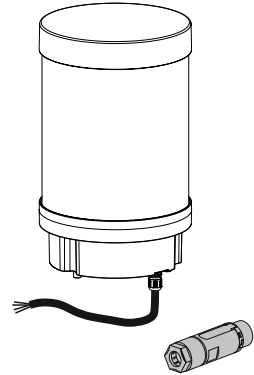

d)

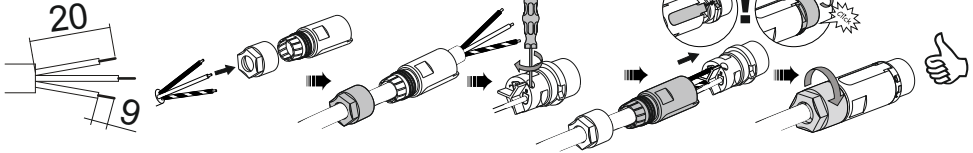

Leitung Leuchtenkopf
Luminaire head cable

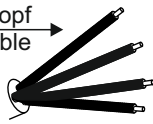

1 = 3
2 = N
3 = 1
4 = 2

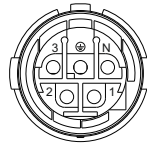

Anschluss Ladesäule
Connection charging station

e)

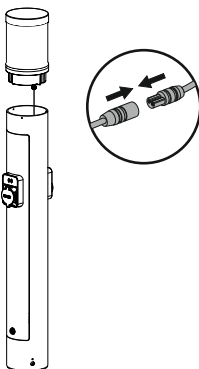

f)

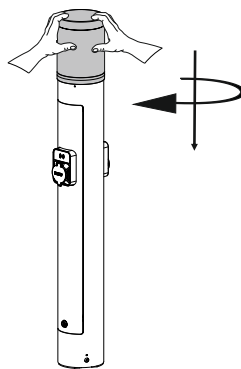

g)

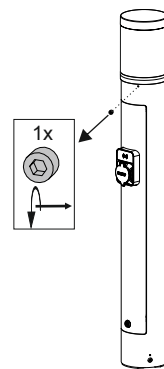







RZB - Rudolf Zimmermann, Bamberg GmbH

 Rheinstraße 16, 96052 Bamberg

 0951/7909-0

 0951/7909-198

 info@rzb-leuchten.de