

INSTRUCTION

Mega Tube
611919.004.1.730



~ 220 - 240 V 50/60 Hz IP 65 IK05



 3 x 2,5 mm²

 2,50 mm²



 Umgebungstemperatur /
temperature ambiante
=> -20 °C ... + 40 °C

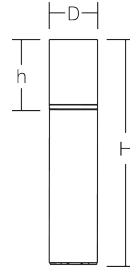

D 156, H 1400



7,6 kg



LED

Φ [lm]

2150

P_{in} [W]

18

P_{out}

1 x 15,9 W

CCT [K]

4000

CRI

80

RG [Ra]

RG 1

EEK [Energy Efficiency Class]

E

I_{max} [A]

5 A / 50 μ s

B10 [St.]

32

B16 [St.]

50

C10 [St.]

52

C16 [St.]

85

$\cos \varphi$

0,95





Allgemeine Sicherheitshinweise

- Der elektrische Anschluss muss ordnungsgemäß nach geltenden Normen und den nationalen sowie internationalen Sicherheits- und Unfallverhütungsvorschriften erfolgen.
- Beschädigte Leuchten dürfen nicht betrieben werden.
- Keine Haftung für Schäden durch unsachgemäßen Einsatz.
- Bei Instandsetzung nur Originalteile verwenden.
- Tragfähigkeit der Decke und Befestigungselemente sicherstellen.

Betrieb der Leuchte

- Die unzulässigen Umgebungstemperaturen reduzieren die Lebensdauer der Leuchte, im Extremfall droht der Frühausfall.
- Zur Vermeidung von EMV-Problemen die Durchgangsverdrahtung nicht entlang der Leuchtenverdrahtung führen.
- Steuereingänge von dimmbaren Leuchten mit handelsüblichen für Netzspannung geeigneten Leitungen anschließen.

Manipulationen unserer Produkte sind unzulässig

Veränderung, Umarbeitung, Umkennzeichnung von Produkten sowie deren Verpackung sind unzulässig und verletzen u.a. unsere eingetragenen Warenzeichenrechte. Solche Modifikationen können technische Eigenschaften unserer Produkte negativ beeinflussen, diese zerstören und möglicherweise Folgeschäden an anderen Objekten verursachen. Für durch derartige Modifikationen verursachte Schäden kann der Hersteller in keinem Fall verantwortlich gemacht werden.



General Safety Information

- Electric connection must be appropriate according to all applicable standards and other national and international safety and accident prevention regulations.
- Damaged luminaires must not be operated.
- No liability is accepted for damages resulting from improper use.
- Use genuine parts only for repair.
- Ensure stability of the ceiling and fastening elements.

Operation of the luminaire

- Exceeding the permissible ambient temperature will reduce the luminaire's lifecycle, resulting in premature failure in extreme cases.
- Avoid ESD problems by not routing feed-through wiring directly along the wiring of the luminaire.
- Connect control inputs of dimmable luminaires with standard cables suitable for power supply voltage.

Manipulation of our products is not permitted

Modifications, reworking, re-labelling of products as well as their package is not permitted and infringes, amongst others, our registered trademark rights. Such modifications may affect technical properties of our products, damage them and possibly cause consequential damage to other objects. The manufacturer shall not be responsible under any circumstances for damage caused by such modifications.



Bei Fragen zu unseren Symbolen, besuchen Sie folgende Webseite:
If you have any questions about our signs, visit the following website:



https://www.rzb.de/fileadmin/assets/downloads/PDF/RZB_Symbolklaerung.pdf

EEK 



Dieses Produkt enthält eine Lichtquelle der Energieeffizienzklasse E entsprechend Verordnung (EU) 2019/2015

This product contains a light source of energy efficiency class E according to regulation (EU) No 2019/2015

 →  Jede zersprungene Schutzabdeckung ist zu ersetzen. DIN EN 60598

 →  Replace any cracked protective shield. IEC DIN EN 60598

  Die Lichtquelle dieser Leuchte darf nur vom Hersteller oder einem von ihm beauftragten Servicetechniker oder einer vergleichbar qualifizierten Person ersetzt werden. DIN EN 60598-1 / IEC 60598-1

  The light source contained in this luminaire shall only be replaced by the manufacturer or his service agent or a similar qualified person. DIN EN 60598-1 / IEC 60598-1

Reichweite Range

Funk-Sender / Empfänger
transmitter / receiver

Betriebsfrequenzen:
Operating Conditions: 2,4 ... 2,483 GHz

Max. Ausgangsleistung:
Max. Output power: + 4 dBm

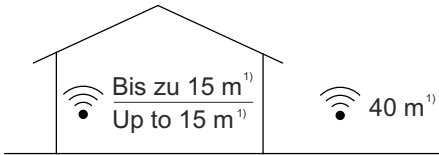

¹⁾Die Reichweite ist stark von den umliegenden Hindernissen wie Wänden und den Baumaterialien abhängig.

Range is highly dependant on the surrounding and obstacles such as walls and building materials.



Kompatible Geräte:
Compatible devices:

- ✓ iPhone 4S oder später
or later
- ✓ iPod 3 oder später
or later
- ✓ iPod Touch 5th Gen. oder später
or later
- ✓ Android 4.4 oder später
KitKat produziert als
2013 mit kompletter Blue-
tooth 4.0 Unterstützung
or later devices produced
after 2013 with full BT 4.0
support

Mit Casambi Mesh Network Technologie agiert jede Steuereinheit auch als ein Repeater. Durch den Einsatz mehrerer Casambi Units können größere Reichweiten erreicht werden.

Casambi uses mesh network technology so each CBU-ASD acts also as a repeater. Longer ranges can be achieved by using multiple Casambi units.



Die Reichweite des Funksignals hängt von der Umgebung ab, z.B. Leuchte, Möbel, Menschen oder der Gebäudekonstruktion. Sie muss in der Installation geprüft und abgenommen werden.

The range of the radio signal depends on the environment, e.g. on luminaire, building construction, furniture or people. It must be tested and approved in the installation.



Um eine gute Funkverbindung zu gewährleisten, darf die Steuereinheit nicht komplett mit Metall verdeckt werden!

To ensure a good radio connection, the control unit must not be completely covered with metal!



Erstmalige Anwendung



Die Casambi App ist leicht zu installieren. Folgen Sie einfach diesen Schritten:

First time use

Casambi app is easy to use. Follow these simple steps:

1. Casambi- App aus dem Apple App Store oder Google Play Store downloaden.
Download the app from Apple App Store or Google Play Store.
2. Smart + free- Steuereinheit betriebene Leuchte einschalten
Switch on your Casambi enabled luminaires.
3. App öffnen.
Open the app.
4. Die App findet automatisch die Leuchten, die eingeschaltet sind
Casambi app will automatically find all Casambi enabled luminaires that are switched on.
5. Klicken Sie auf „Alle Leuchten in Benutzung nehmen“.
Click on „Take all lamps into use“.
6. Die Leuchten werden automatisch zu einem Netzwerk hinzugefügt.
Casambi app will automatically add all found luminaires to one network and open the „Lamps“ tab.
7. Vergeben Sie eine von vier Freigabeoptionen für ihr Netzwerk (siehe Seite „Netzwerke und Freigabe“)
Assign one of four sharing options for your network (see page „Network setup and sharing“).

Zusatzinfo

Additional info



Link zum iOS
Link to iOS



Link zum Android
Link to Android



Link zur weiteren Information



Link to more information



DICHIARAZIONE DI CONFORMITA' UE (EU CONFORMITY DECLARATION)

La ditta: TCI TELECOMUNICAZIONI ITALIA S.r.l.
The company: Via Parma 14, 21047 SARONNO (VA) - ITALY

dichiara sotto la propria responsabilità che il/i seguente/i prodotto/i :
declares under its own responsibility that the/following product/s:

Descrizione prodotto: ALIMENTATORE WIRELESS per moduli LED (alimentazione AC)
Product description: Wireless controlgear for LED module (AC supply)

Modello/i prodotto/i: Vedere lista allegata
Product type/s: See attached list

rispondono ai requisiti essenziali delle seguenti direttive e conformi alle relative norme armonizzate:
meets the essential requirements of the following directives and according to the related harmonised standards:

2014/53/EU
EN 61347-1:2015, EN 61347-2-13:2014+A1:2017, EN 62311:2020,
EN 61000-3-2:2014, EN 61000-3-3:2013, EN 55015:2019+A11:2020,
ETSI EN 300 328 V2.2.2:2019, ETSI EN 301 489-1 V2.2.3:2019, ETSI EN 301 489-17 V3.2.0:2017

2009/125/EC – COMMISSION REGULATIONS (EU) No. 2019/2020 and 341/2021 amendment
EN 62442-3:2014+A11:2017, EN 62442-3:2018

2011/65/EU, 2015/863/EU and amendments
EN IEC 63000:2018

Questa dichiarazione di conformità è rilasciata sotto la sola responsabilità del produttore.
This declaration of conformity is issued under the sole responsibility of the manufacturer.

luogo e data: SARONNO, 24/02/2022
place and date:



V. Bonanomi (Certification Manager)
(nome e firma della persona autorizzata)
(name and signature of authorized person)

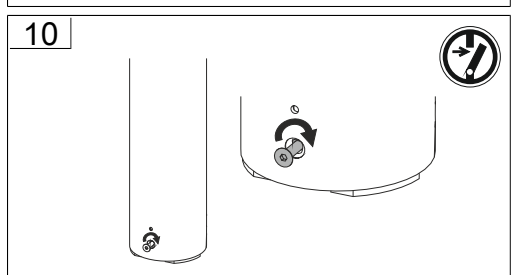
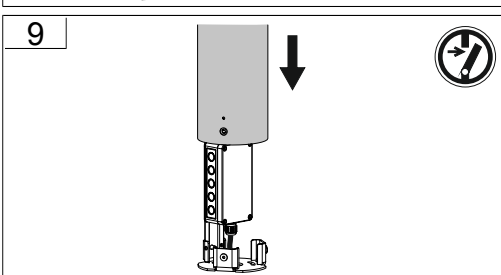
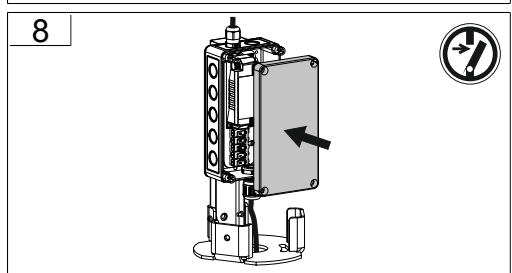
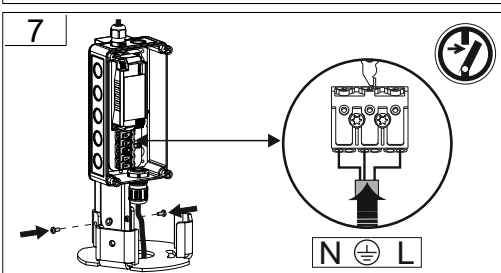
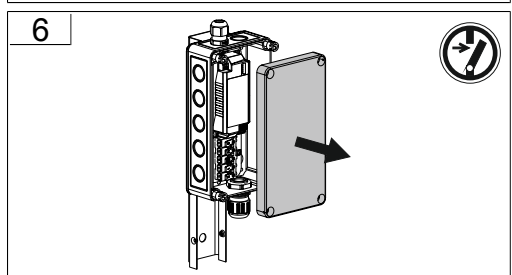
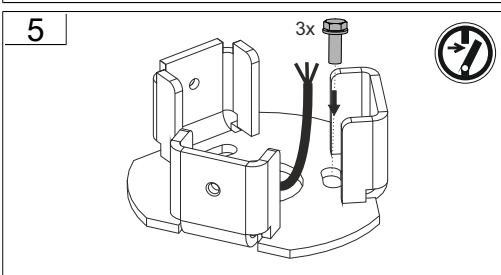
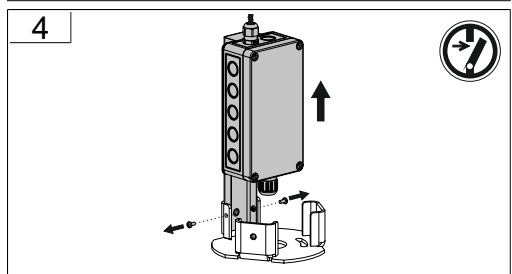
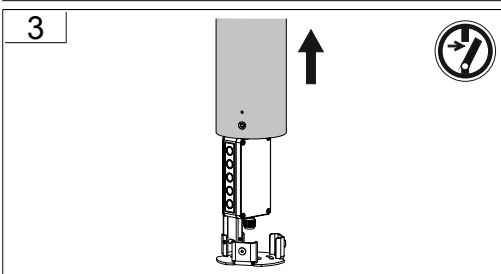
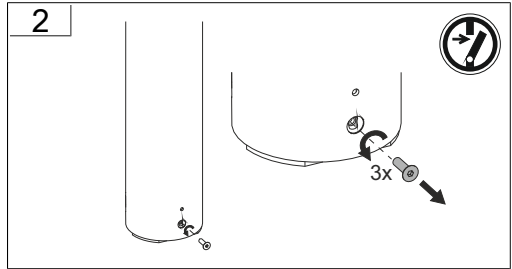
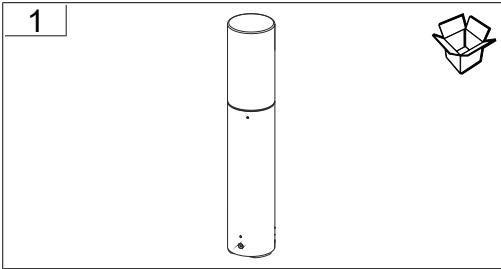



11

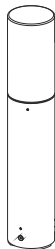

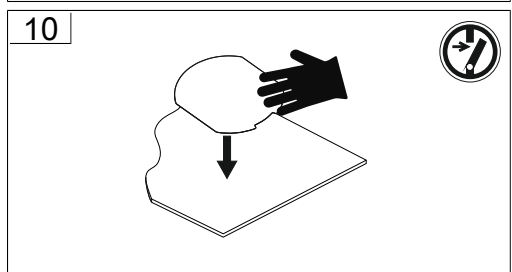
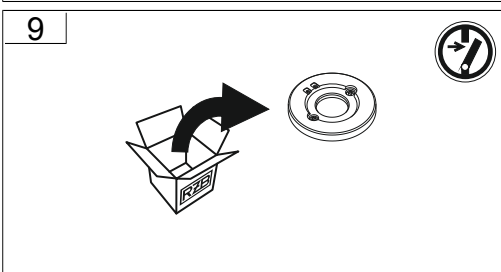
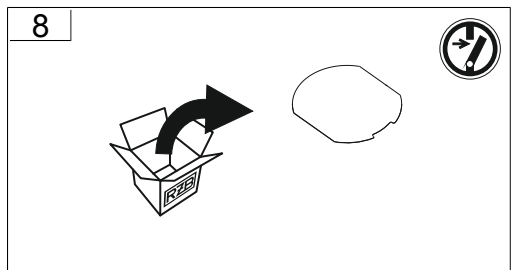
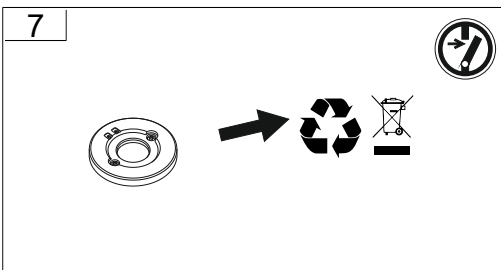
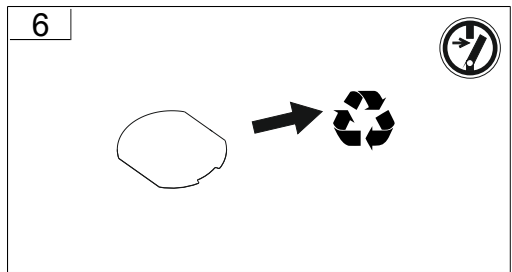
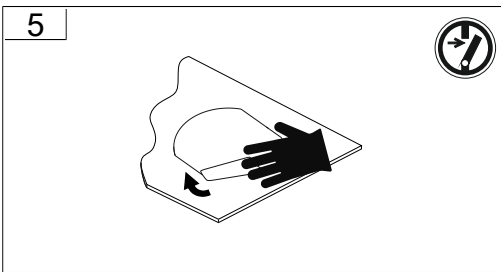
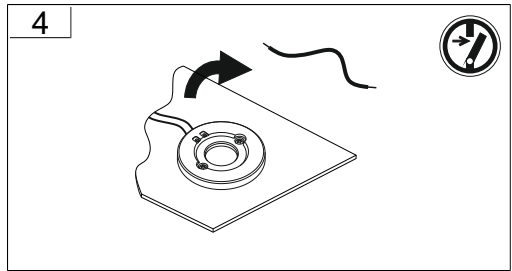
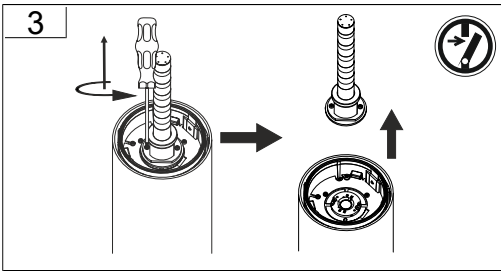
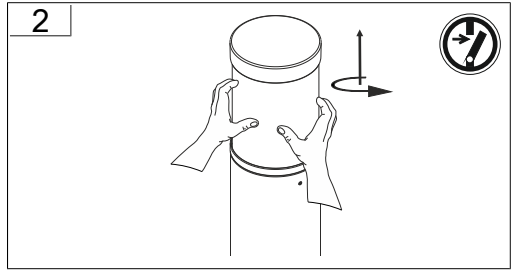
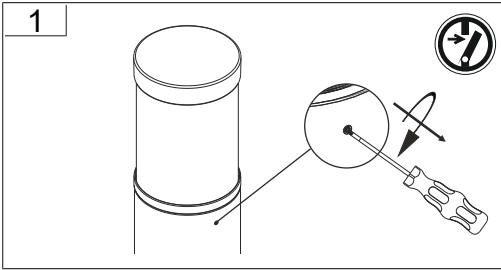

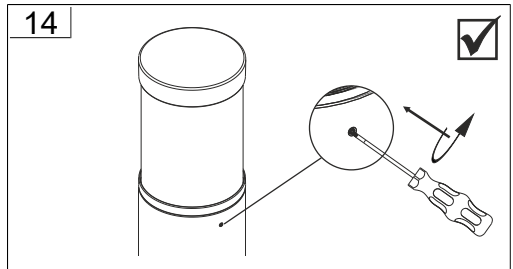
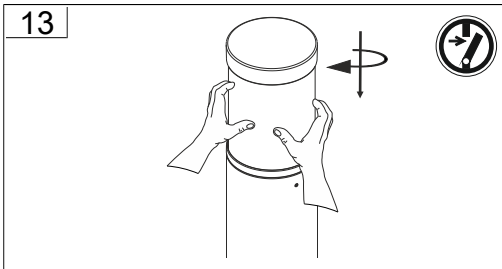
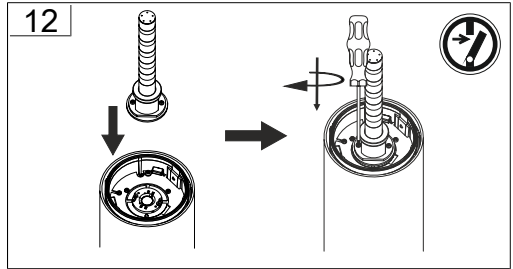
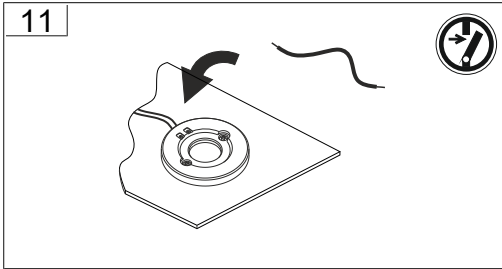

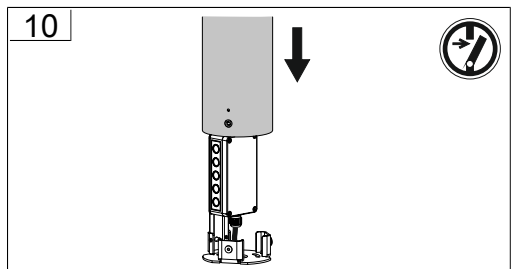
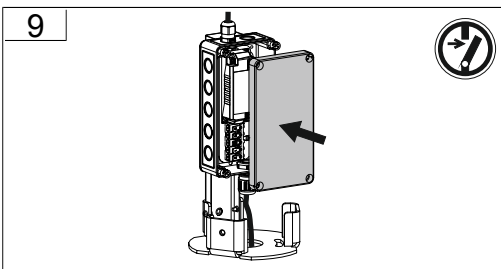
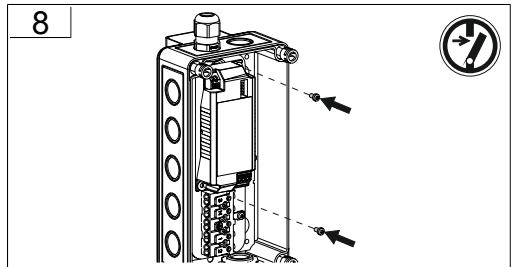
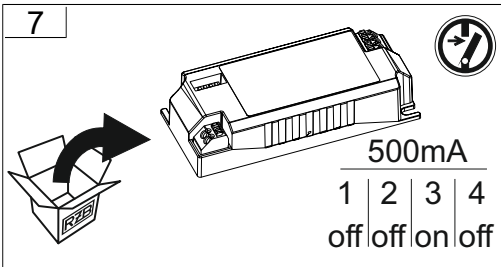
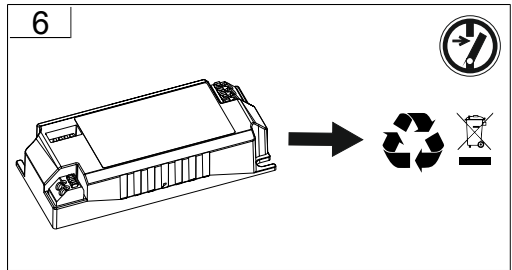
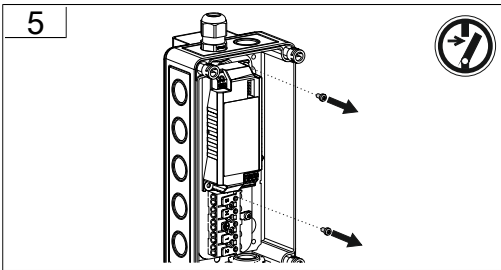
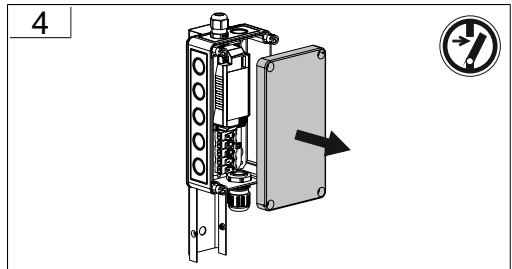
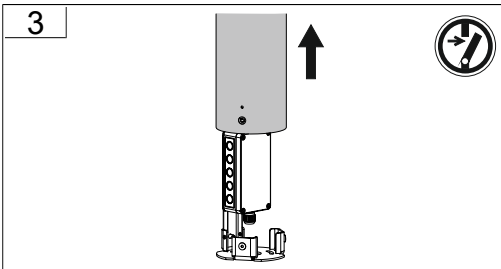
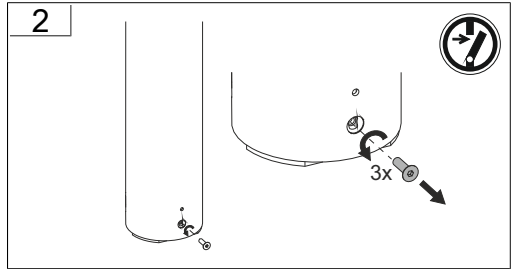
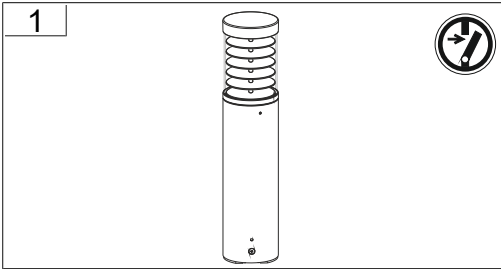

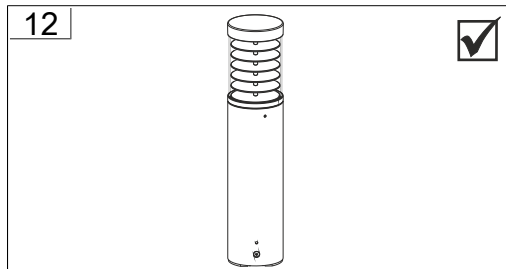
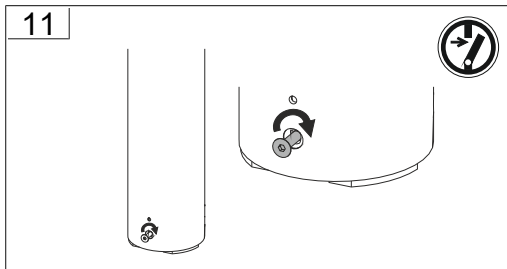

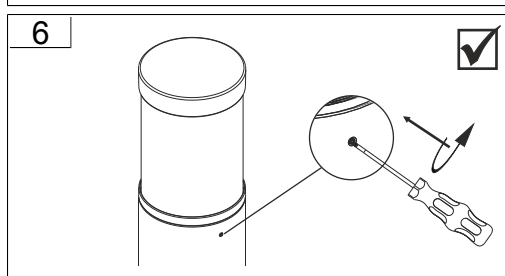
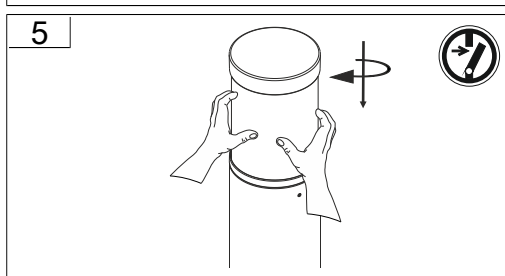
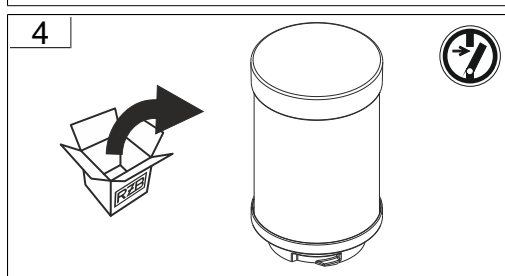
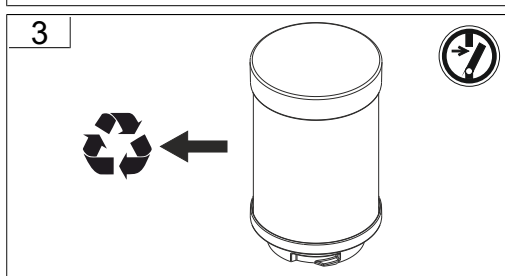
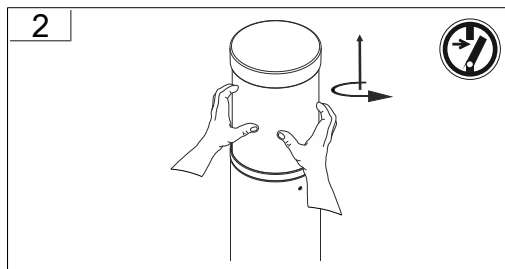
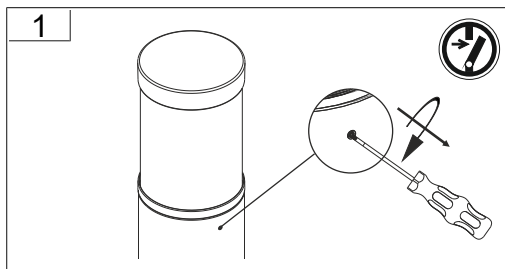

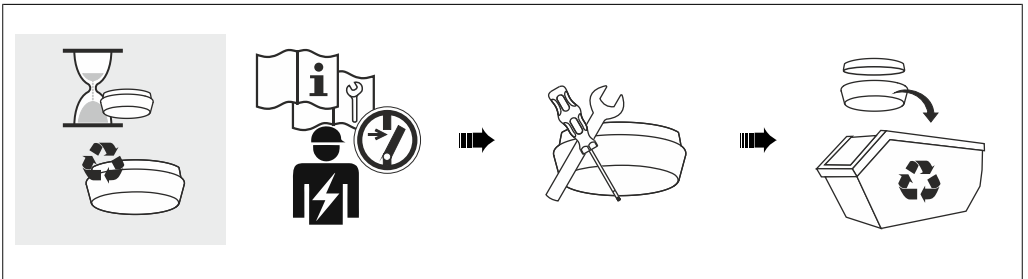
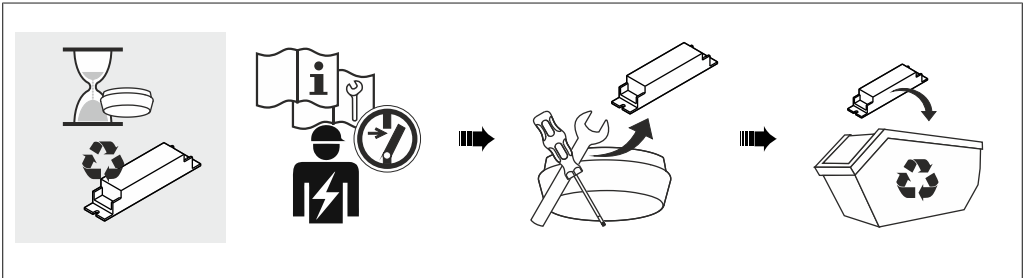
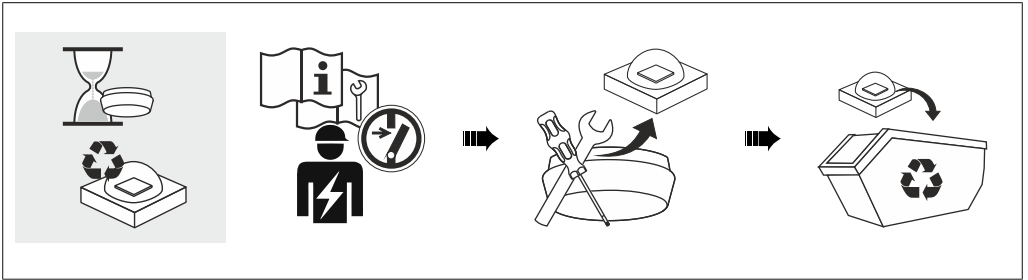



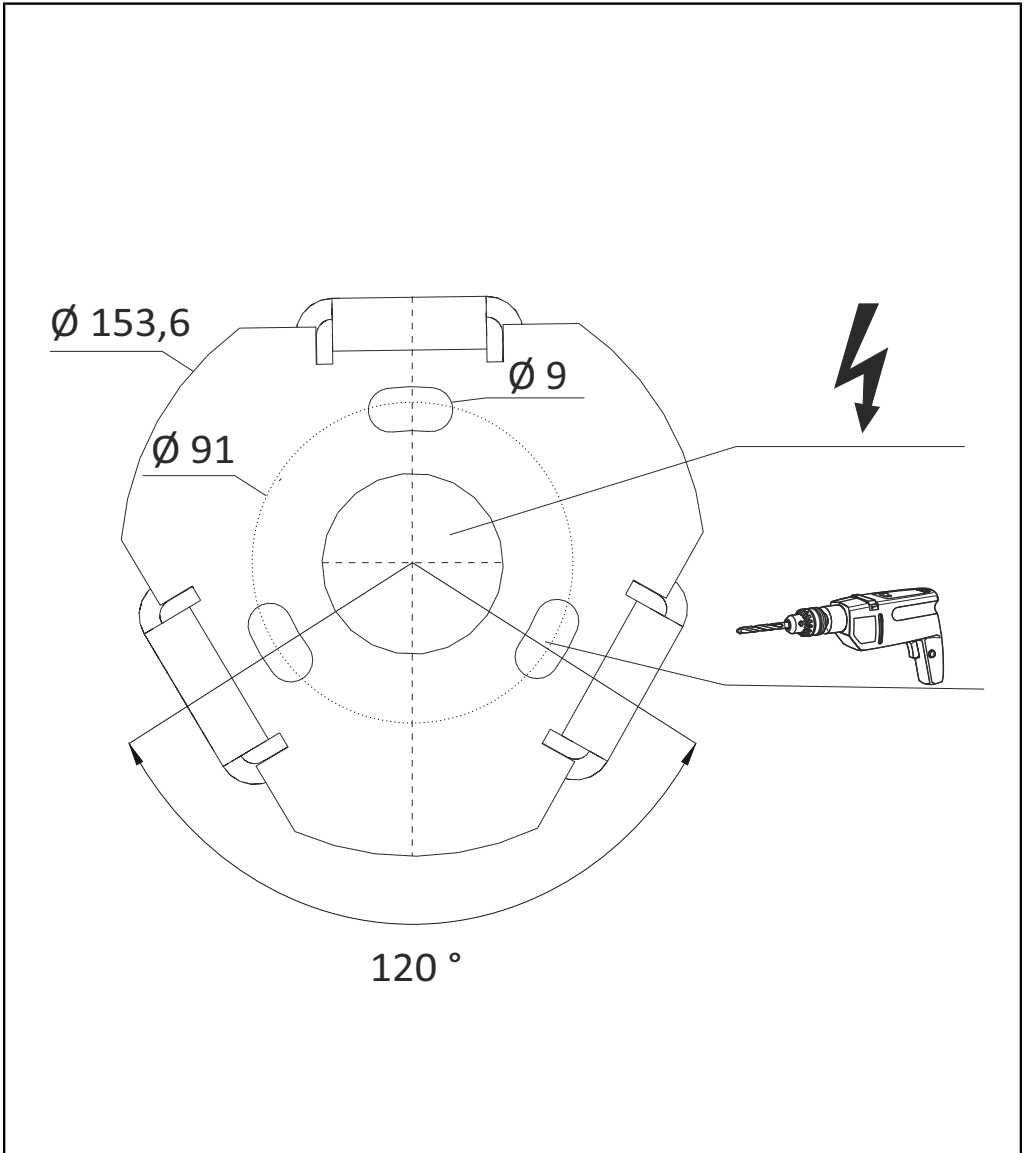





RZB - Rudolf Zimmermann, Bamberg GmbH

 Rheinstraße 16, 96052 Bamberg

 0951/7909-0

 0951/7909-198

 info@rzb-leuchten.de