

# INSTRUCTION

Flat Slim Disc  
312651.004.76

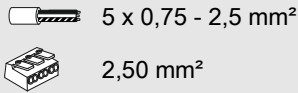

~ 220 - 240 V 50/60 Hz IP 40, IP 40 IK03



Umgebungstemperatur /  
temperature ambiante  
=> -25 °C ... + 40 °C

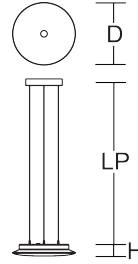

D 480, H 75



LP 500-1500



6,8 kg



$\Phi$  [lm]

$P_{\square}$  [W]

$P_{\circ}$

LED

3850

41

1 x 34 W

CCT [K]

CRI

RG  $\square$

EEK  $\square$

3000

80

RG 1

D



21 A / 230  $\mu$ s



12



20



21



34

$\cos \varphi$

0,99

$f_{\min} - f_{\max}$   
[MHz]

13,553 – 13,567

$p_{EIRP}$  [mW]

0





Installation erfordert  
Elektro-Fachkraft!

Symbole nach ISO 7010



### Allgemeine Sicherheitshinweise

- Der elektrische Anschluss muss ordnungsgemäß nach geltenden Normen und den nationalen sowie internationalen Sicherheits- und Unfallverhütungsvorschriften erfolgen.
- Beschädigte Leuchten dürfen nicht betrieben werden.
- Keine Haftung für Schäden durch unsachgemäßen Einsatz.
- Bei Instandsetzung nur Originalteile verwenden.
- Tragfähigkeit der Decke und Befestigungselemente sicherstellen.

### Betrieb der Leuchte

- Die unzulässigen Umgebungstemperaturen reduzieren die Lebensdauer der Leuchte, im Extremfall droht der Frühausfall.
- Zur Vermeidung von EMV-Problemen die Durchgangsverdrahtung nicht entlang der Leuchtenverdrahtung führen.
- Steuereingänge von dimmbaren Leuchten mit handelsüblichen für Netzspannung geeigneten Leitungen anschließen.

### Manipulationen unserer Produkte sind unzulässig

Veränderung, Umarbeitung, Umkennzeichnung von Produkten sowie deren Verpackung sind unzulässig und verletzen u.a. unsere eingetragenen Warenzeichenrechte. Solche Modifikationen können technische Eigenschaften unserer Produkte negativ beeinflussen, diese zerstören und möglicherweise Folgeschäden an anderen Objekten verursachen. Für durch derartige Modifikationen verursachte Schäden kann der Hersteller in keinem Fall verantwortlich gemacht werden.



Installation requires  
a qualified electrician!

Symbols according  
to ISO 7010



### General Safety Information

- Electric connection must be appropriate according to all applicable standards and other national and international safety and accident prevention regulations.
- Damaged luminaires must not be operated.
- No liability is accepted for damages resulting from improper use.
- Use genuine parts only for repair.
- Ensure stability of the ceiling and fastening elements.

### Operation of the luminaire

- Exceeding the permissible ambient temperature will reduce the luminaire's lifecycle, resulting in premature failure in extreme cases.
- Avoid ESD problems by not routing feed-through wiring directly along the wiring of the luminaire.
- Connect control inputs of dimmable luminaires with standard cables suitable for power supply voltage.

### Manipulation of our products is not permitted

Modifications, reworking, re-labelling of products as well as their package is not permitted and infringes, amongst others, our registered trademark rights. Such modifications may affect technical properties of our products, damage them and possibly cause consequential damage to other objects. The manufacturer shall not be responsible under any circumstances for damage caused by such modifications.



Bei Fragen zu unseren Symbolen, besuchen Sie folgende Webseite:  
 If you have any questions about our signs, visit the following website:







[https://www.rzb.de/fileadmin/assets/downloads/PDF/RZB\\_Symbolklaerung.pdf](https://www.rzb.de/fileadmin/assets/downloads/PDF/RZB_Symbolklaerung.pdf)

**EEK** 

Dieses Produkt enthält eine Lichtquelle der Energieeffizienzklasse D entsprechend Verordnung (EU) 2019/2015

This product contains a light source of energy efficiency class D according to regulation (EU) No 2019/2015

 →  Jede zersprungene Schutzabdeckung ist zu ersetzen. DIN EN 60598

 →  Replace any cracked protective shield. IEC DIN EN 60598

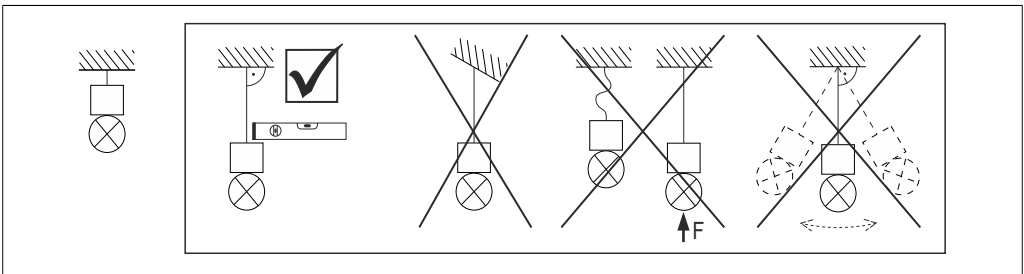



Apply Thinly

Das beigegefügte Schmierfett dient als Montagehilfe und ist nur bei Bedarf zu verwenden. Falls Sie beim Aufschrauben des Glases auf die Armatur einen starken Widerstand spüren, geben Sie eine geringe Menge des Fetts auf die Dichtung.

The enclosed grease serves as an assembly aid and should only be used if necessary. If you feel strong resistance when screwing the glass onto the fitting, apply a small amount of the grease to the gasket.



**EG-Konformitätserklärung**  
**EC-Declaration of Conformity**  
**Déclaration UE de conformité**  
**Declaración de conformidad CE**  
**Deklaracja zgodności UE**



**Hersteller, Anschrift:**  
**Manufacturer, address:**  
**Fabricant, adresse:**  
**Fabricante, dirección:**  
**Producent, adres:**

**RZB Rudolf Zimmermann, Bamberg GmbH**  
**Rheinstrasse 16**  
**96052 Bamberg**  
**Deutschland / Germany / Allemagne / Alemania / Niemcy**

Wir erklären in alleiniger Verantwortung, dass das Produkt  
 We declare under sole responsibility that the product  
 Nous déclarons, sous notre propre responsabilité, que le produit  
 Declaramos bajo nuestra sola responsabilidad que el producto  
 Deklarujemy z pełną odpowiedzialnością, że produkt

**Produktbezeichnung:**  
**Product designation:** Flat Slim Disc  
**Description des produits:**  
**Designación de producto:** 312651.004.76  
**Oznaczenie produktu:**

mit den folgenden EG-Richtlinien und Normen übereinstimmt:  
 complies with the following EC Directives and standards:  
 est conforme aux normes et directives de l'UE suivantes:  
 cumple con las siguientes directivas y normas CE:  
 jest zgodny z następującymi dyrektywami UE i normami:

<p><b>RED Directive</b> 2014/53/EU</p>	<p><b>(3.1a)</b> EN 60598-1:2021/A11:2022 EN 60598-2-1:1989 EN 62471:2008 EN 62493:2010 <b>(3.1b)</b> EN 55015:2019/A11:2020 EN 61000-3-2:2019/A1:2021 EN 61000-3-3:2013+A1:2019+A2:2021+A2:2021/AC:2022 EN 61547:2023 <b>(3.2)</b> EN 300 330:V2.1.1</p>
<p><b>RoHS Directive</b> 2011/65/EU</p>	<p>EN 63000:2018</p>
<p><b>ErP Directive</b> 2009/125/EC</p>	<p>(EU) 2019/2020</p>

Dokument-Nr. / Document No. / Document No. **24001851**  
 Document No. / Nr dokumentu

Aussteller / Issuer / Délivré par: **RZB Rudolf Zimmermann, Bamberg GmbH**  
 Otagante / Wystawca:

Ort, Datum / Place, Date / Lieu, date: **Bamberg, 02.02.2024**  
 Lugar, Fecha / Miejsce, data:

Rechtsverbindliche Unterschrift:  
 Legally binding signature:  
 Signature juridiquement obligatore:  
 Firma legalmente vinculante:  
 Prawnie wiązacy podpis:

  
 Reiner Jürgens  
 CEO/Direktor Zarządzający/Geschäftsführer

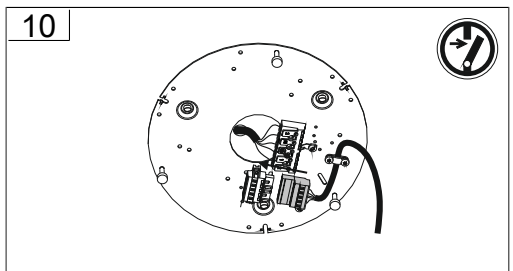
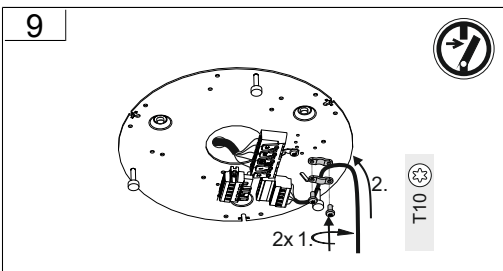
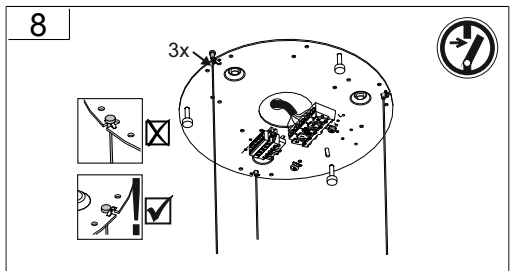
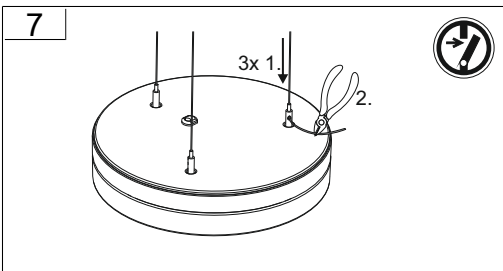
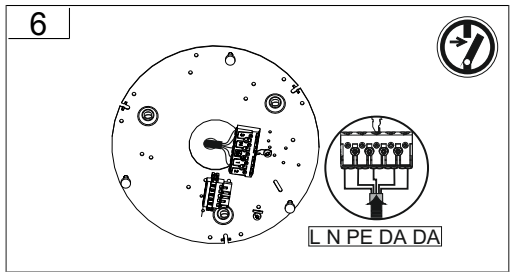
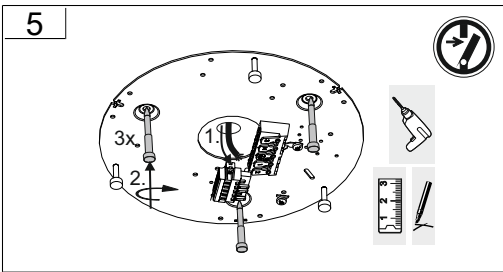
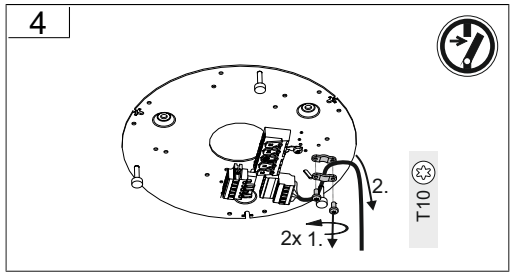
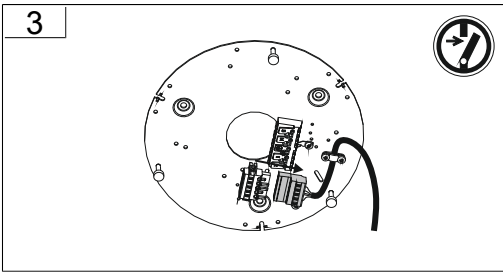
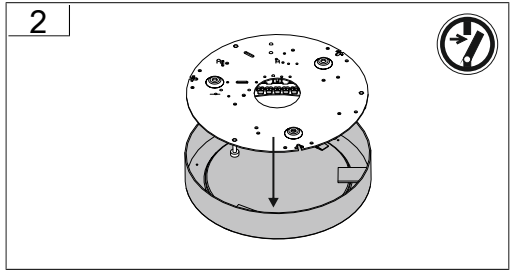
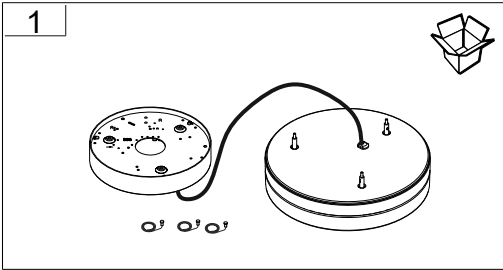



11

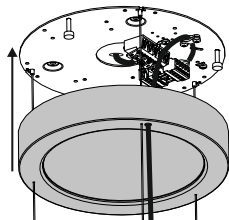

12

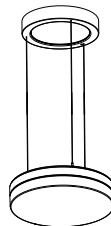

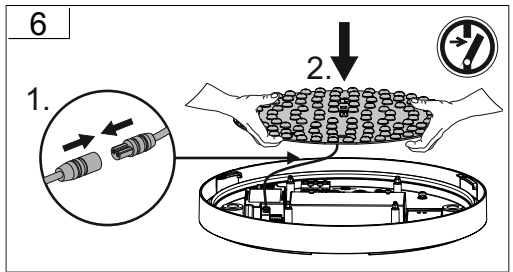
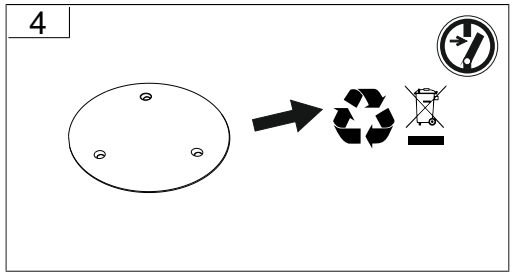
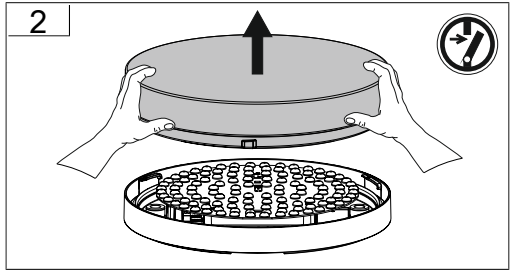

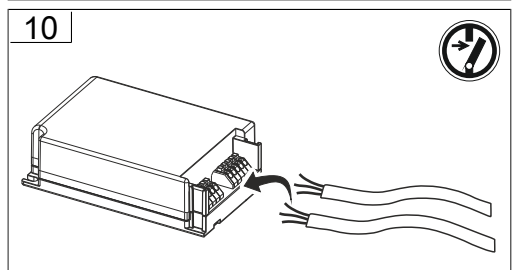
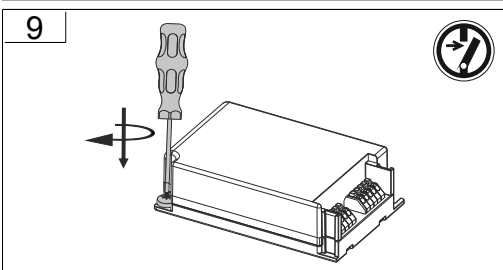
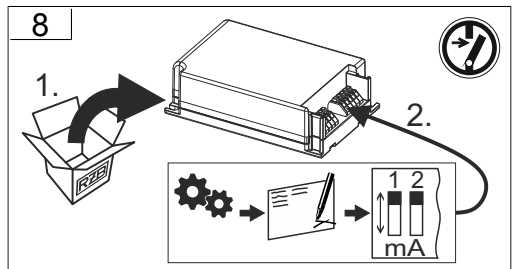
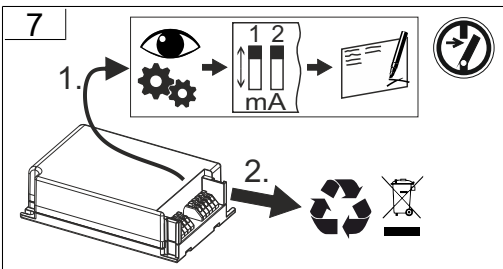
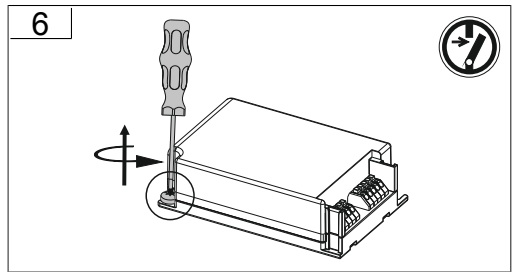
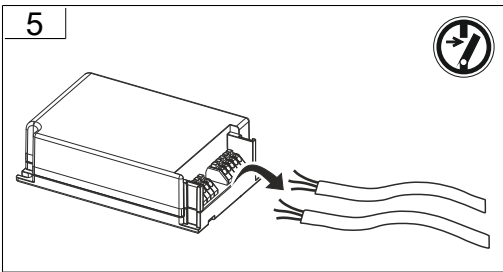
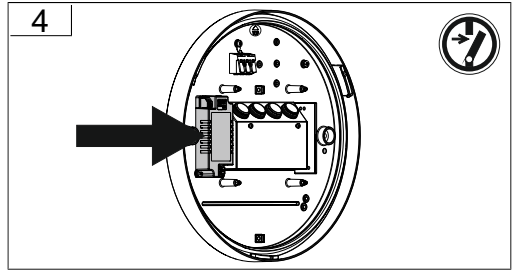
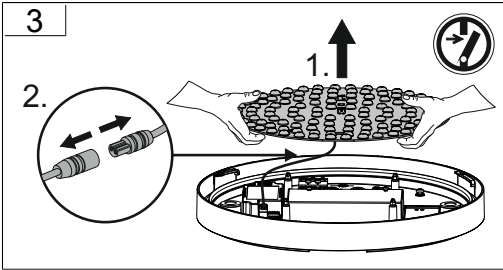
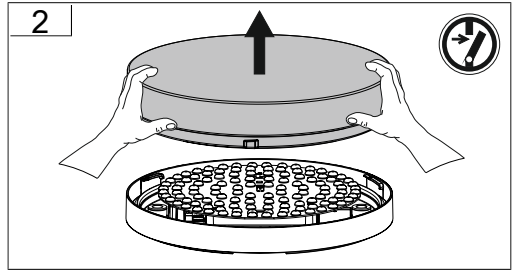
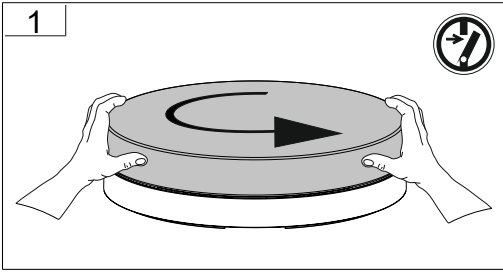

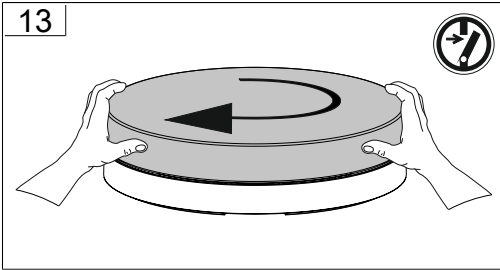
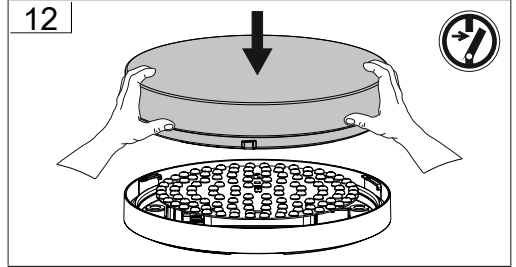
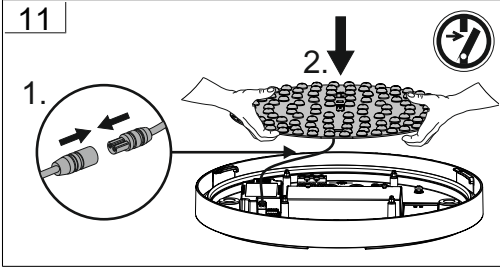

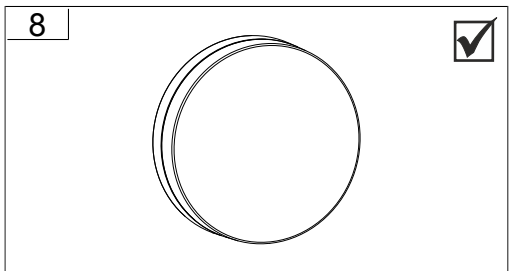
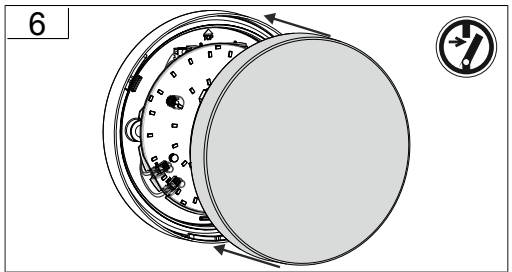
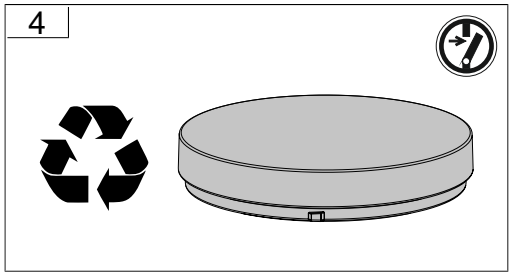









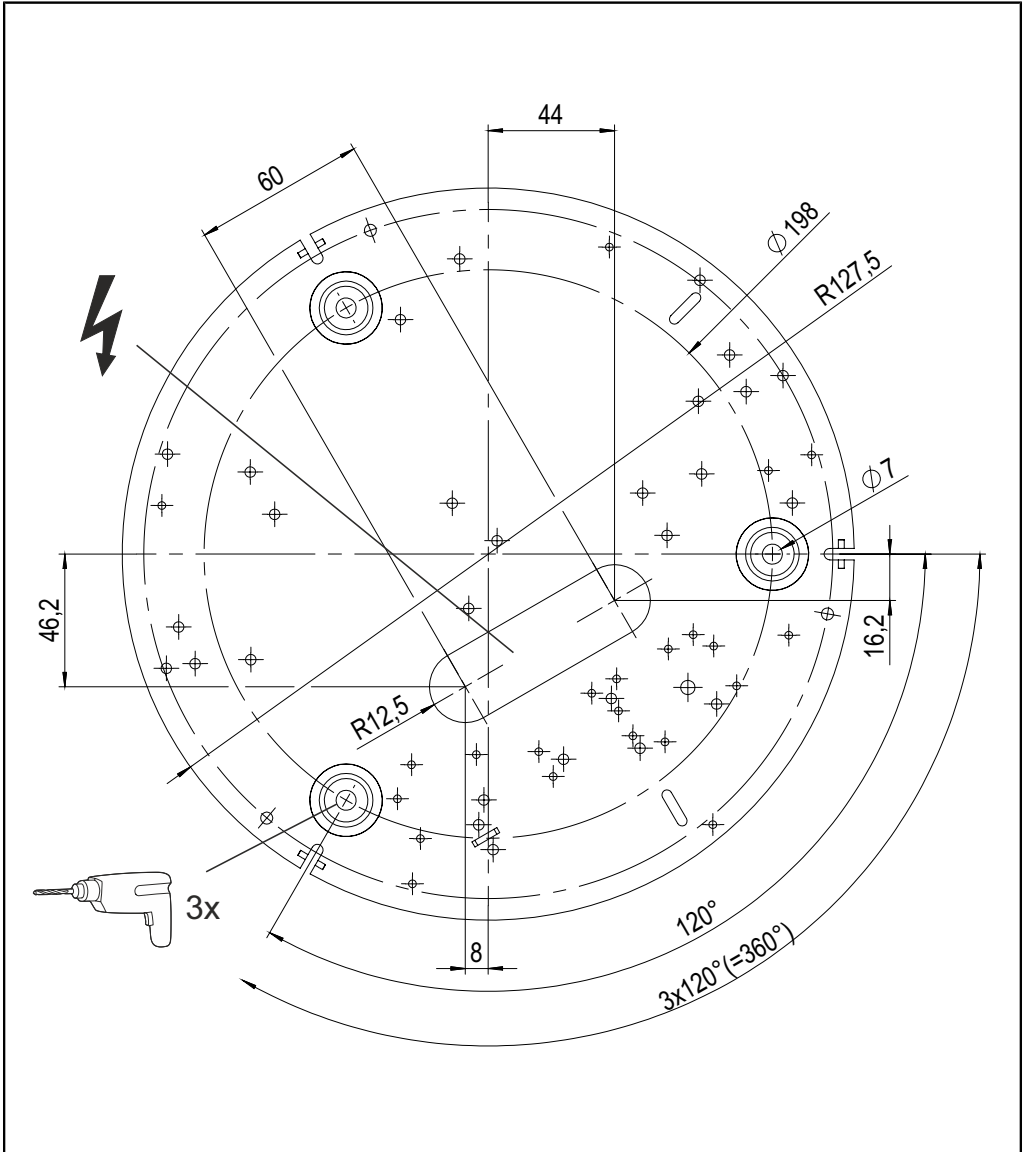

RZB - Rudolf Zimmermann, Bamberg GmbH

🏠 Rheinstraße 16, 96052 Bamberg

☎ 0951/7909-0

📠 0951/7909-198

🌐 [info@rzb-leuchten.de](mailto:info@rzb-leuchten.de)