

# INSTRUCTION

Flat Slim Square  
312543.004

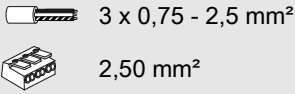

~ 220 - 240 V 50/60 Hz IP 40 IK07



Umgebungstemperatur /  
temperature ambiante  
=> -20 °C ... + 35 °C

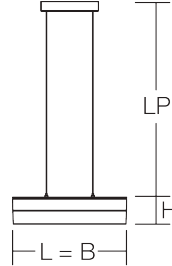

L 430, B 430, H 72



LP 500-1200



10,7 kg



LED



3050



27



1 x 35 W

CCT [K]

3000

CRI

80

RG [Ra]

RG 1

EEK [Energy label]

D

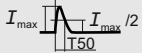

5 A / 50 µs



31



50



52



85

cos φ

0,95

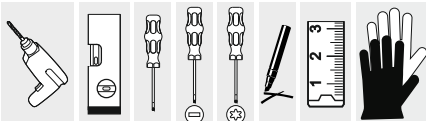



Installation erfordert  
Elektro-Fachkraft!

Symbole nach ISO 7010



### Allgemeine Sicherheitshinweise

- Der elektrische Anschluss muss ordnungsgemäß nach geltenden Normen und den nationalen sowie internationalen Sicherheits- und Unfallverhütungsvorschriften erfolgen.
- Beschädigte Leuchten dürfen nicht betrieben werden.
- Keine Haftung für Schäden durch unsachgemäßen Einsatz.
- Bei Instandsetzung nur Originalteile verwenden.
- Tragfähigkeit der Decke und Befestigungselemente sicherstellen.

### Betrieb der Leuchte

- Die unzulässigen Umgebungstemperaturen reduzieren die Lebensdauer der Leuchte, im Extremfall droht der Frühausfall.
- Zur Vermeidung von EMV-Problemen die Durchgangsverdrahtung nicht entlang der Leuchtenverdrahtung führen.
- Steuereingänge von dimmbaren Leuchten mit handelsüblichen für Netzspannung geeigneten Leitungen anschließen.

### Manipulationen unserer Produkte sind unzulässig

Veränderung, Umarbeitung, Umkennzeichnung von Produkten sowie deren Verpackung sind unzulässig und verletzen u.a. unsere eingetragenen Warenzeichenrechte. Solche Modifikationen können technische Eigenschaften unserer Produkte negativ beeinflussen, diese zerstören und möglicherweise Folgeschäden an anderen Objekten verursachen. Für durch derartige Modifikationen verursachte Schäden kann der Hersteller in keinem Fall verantwortlich gemacht werden.



Installation requires  
a qualified electrician!

Symbols according  
to ISO 7010



### General Safety Information

- Electric connection must be appropriate according to all applicable standards and other national and international safety and accident prevention regulations.
- Damaged luminaires must not be operated.
- No liability is accepted for damages resulting from improper use.
- Use genuine parts only for repair.
- Ensure stability of the ceiling and fastening elements.

### Operation of the luminaire

- Exceeding the permissible ambient temperature will reduce the luminaire's lifecycle, resulting in premature failure in extreme cases.
- Avoid ESD problems by not routing feed-through wiring directly along the wiring of the luminaire.
- Connect control inputs of dimmable luminaires with standard cables suitable for power supply voltage.

### Manipulation of our products is not permitted

Modifications, reworking, re-labelling of products as well as their package is not permitted and infringes, amongst others, our registered trademark rights. Such modifications may affect technical properties of our products, damage them and possibly cause consequential damage to other objects. The manufacturer shall not be responsible under any circumstances for damage caused by such modifications.





Bei Fragen zu unseren Symbolen, besuchen Sie folgende Webseite:  
If you have any questions about our signs, visit the following website:



[https://www.rzb.de/fileadmin/assets/downloads/PDF/RZB\\_Symbolklaerung.pdf](https://www.rzb.de/fileadmin/assets/downloads/PDF/RZB_Symbolklaerung.pdf)



Dieses Produkt enthält eine Lichtquelle der Energieeffizienzklasse D entsprechend Verordnung (EU) 2019/2015

---

This product contains a light source of energy efficiency class D according to regulation (EU) No 2019/2015



Jede zersprungene Schutzabdeckung ist zu ersetzen. DIN EN 60598

---

Replace any cracked protective shield. IEC DIN EN 60598

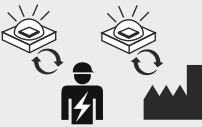

Die Lichtquelle dieser Leuchte darf nur vom Hersteller oder einem von ihm beauftragten Servicetechniker oder einer vergleichbar qualifizierten Person ersetzt werden. DIN EN 60598-1 / IEC 60598-1

---

The light source contained in this luminaire shall only be replaced by the manufacturer or his service agent or a similar qualified person. DIN EN 60598-1 / IEC 60598-1

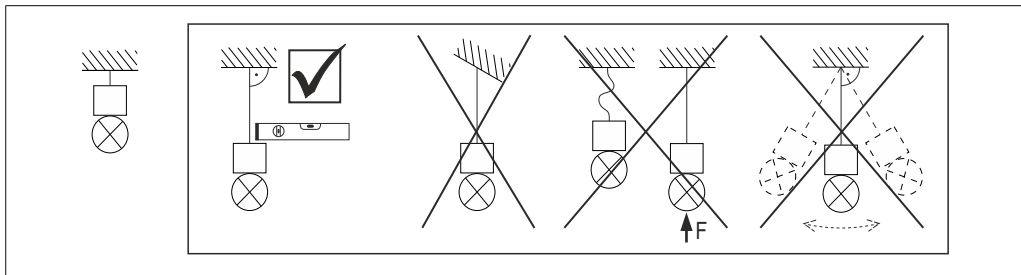



a

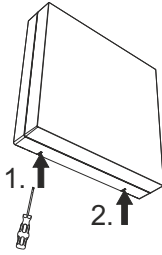

öffnen  
to open

b

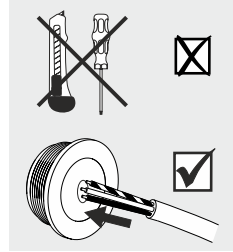

c

Dieser Bereich darf eingestellt werden!

Konvertereinstellungen:

This range may be set!

Converter settings:

lout	1	2	3	4	
<del>300 mA</del>	-	-	-	-	
<del>350 mA</del>	-	-	-	on	
<del>400 mA</del>	-	-	on	-	
<del>450 mA</del>	-	-	on	on	
<del>500 mA</del>	-	on	-	-	
<del>550 mA</del>	-	on	-	on	
<del>600 mA</del>	-	on	on	-	
650 mA	-	on	on	on	2950lm, 3000K 3150lm, 4000K
700 mA	on	-	-	-	
750 mA	on	-	-	on	
800 mA	on	-	on	-	
850 mA	on	-	on	on	
900 mA	on	on	-	-	
950 mA	on	on	-	on	4200lm, 3000K 4500lm, 4000K
<del>1000 mA</del>	on	on	on	-	
<del>1050 mA</del>	on	on	on	on	

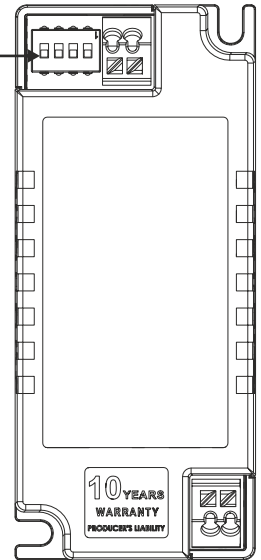



1

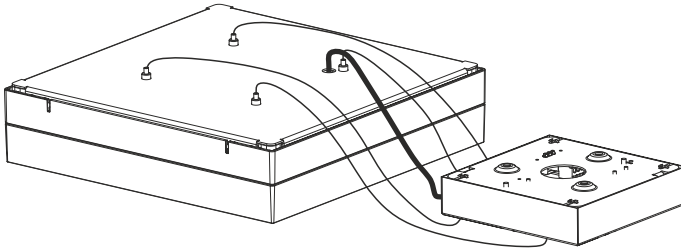

2

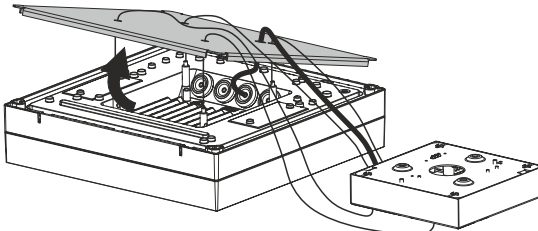

3

drücken  
push

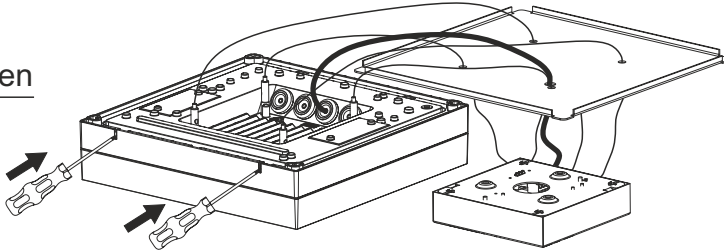

4

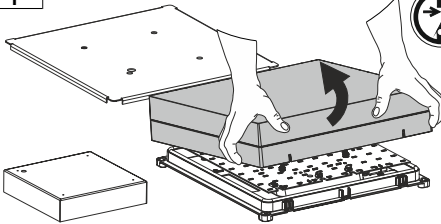

5

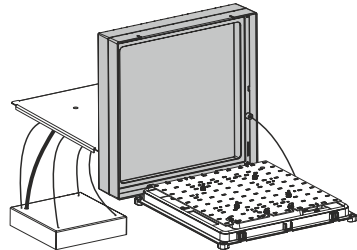

6

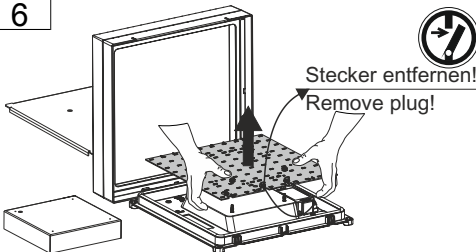

Stecker entfernen!  
Remove plug!



7

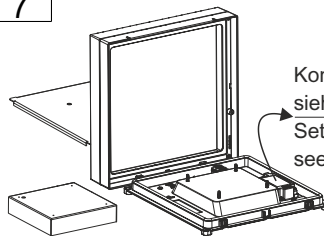

Konverter einstellen  
siehe Info  
Set converter  
see info



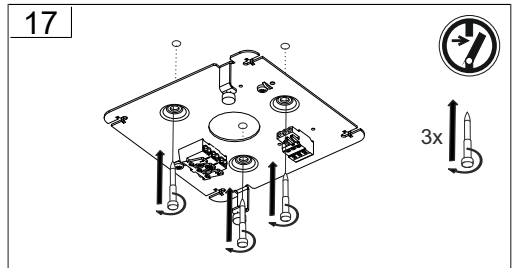
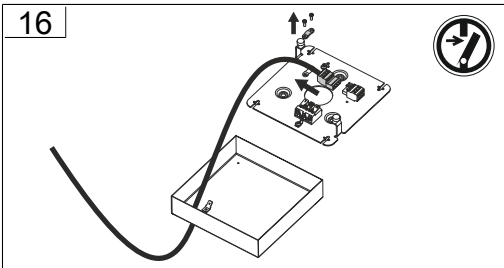
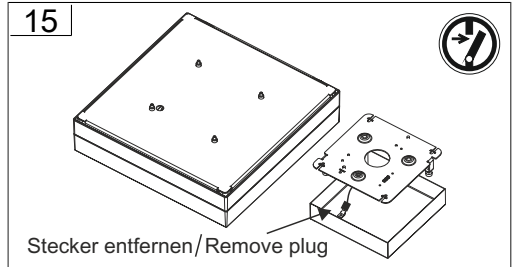
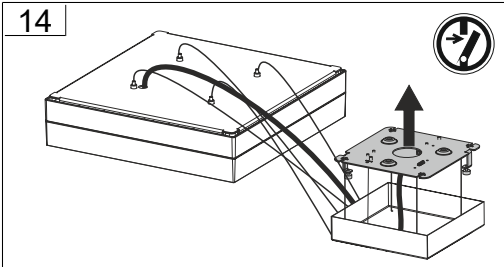
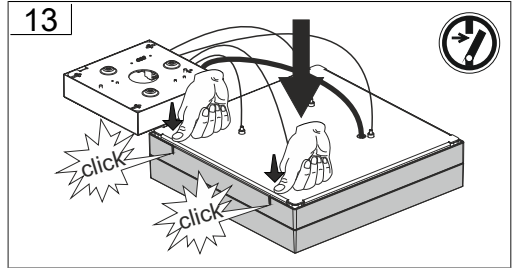
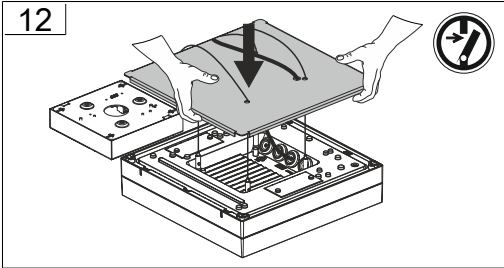
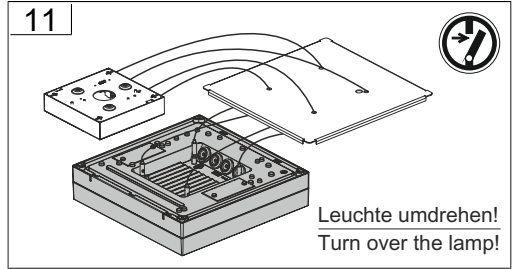
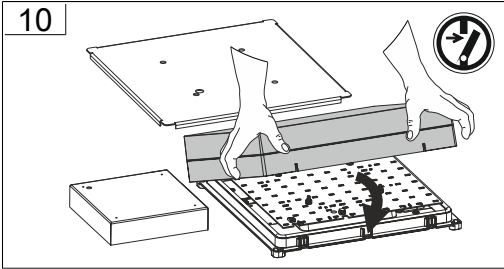
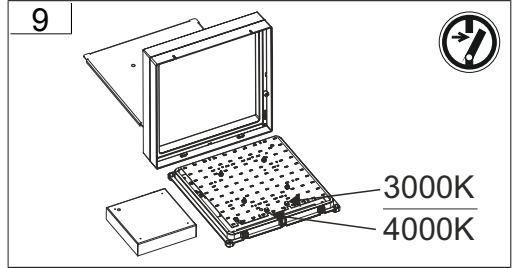
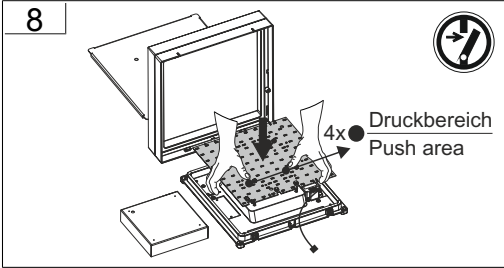



18

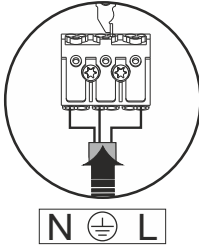

19

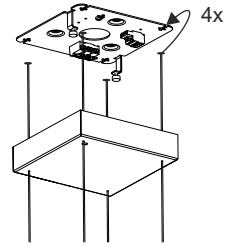

20

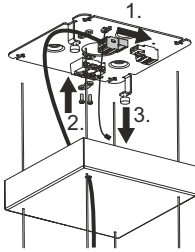

21

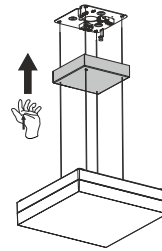

22

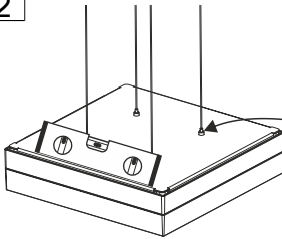

Drücken und  
Seil nachziehen!  
Press and  
Tighten the rope!

23

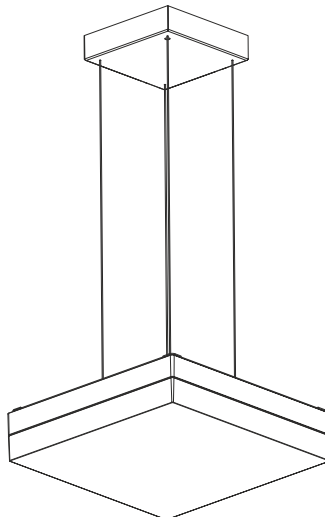



1

öffnen  
to open

2

3

4

5

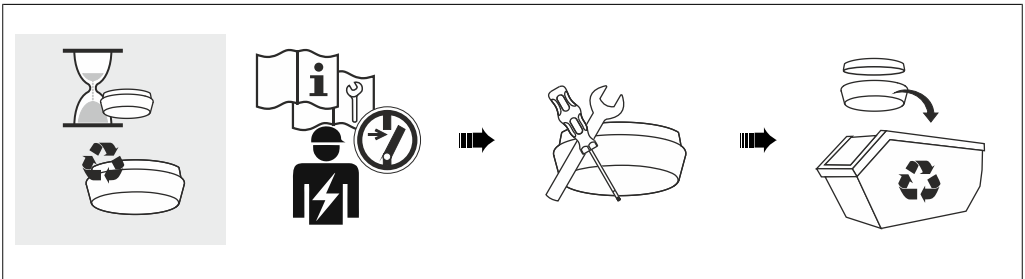
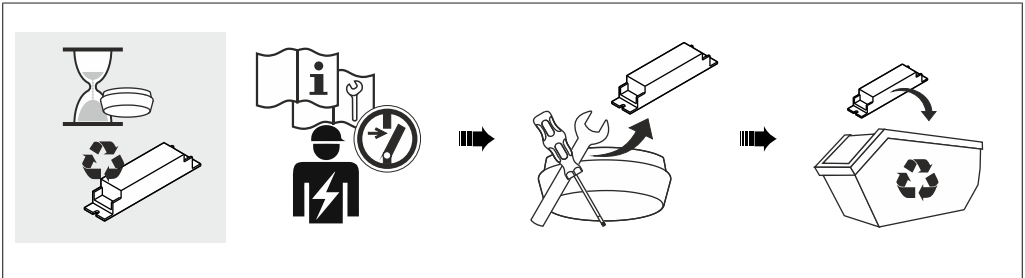
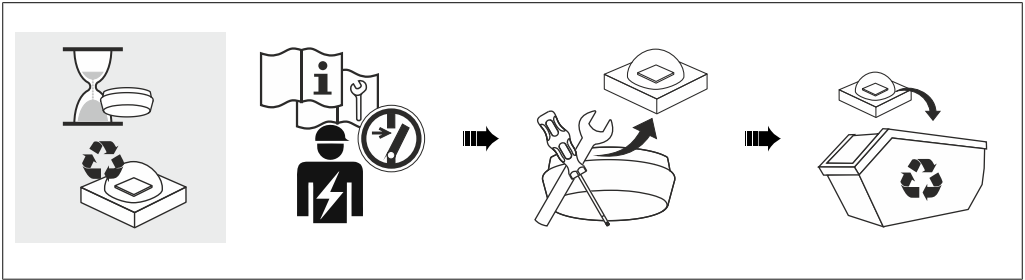



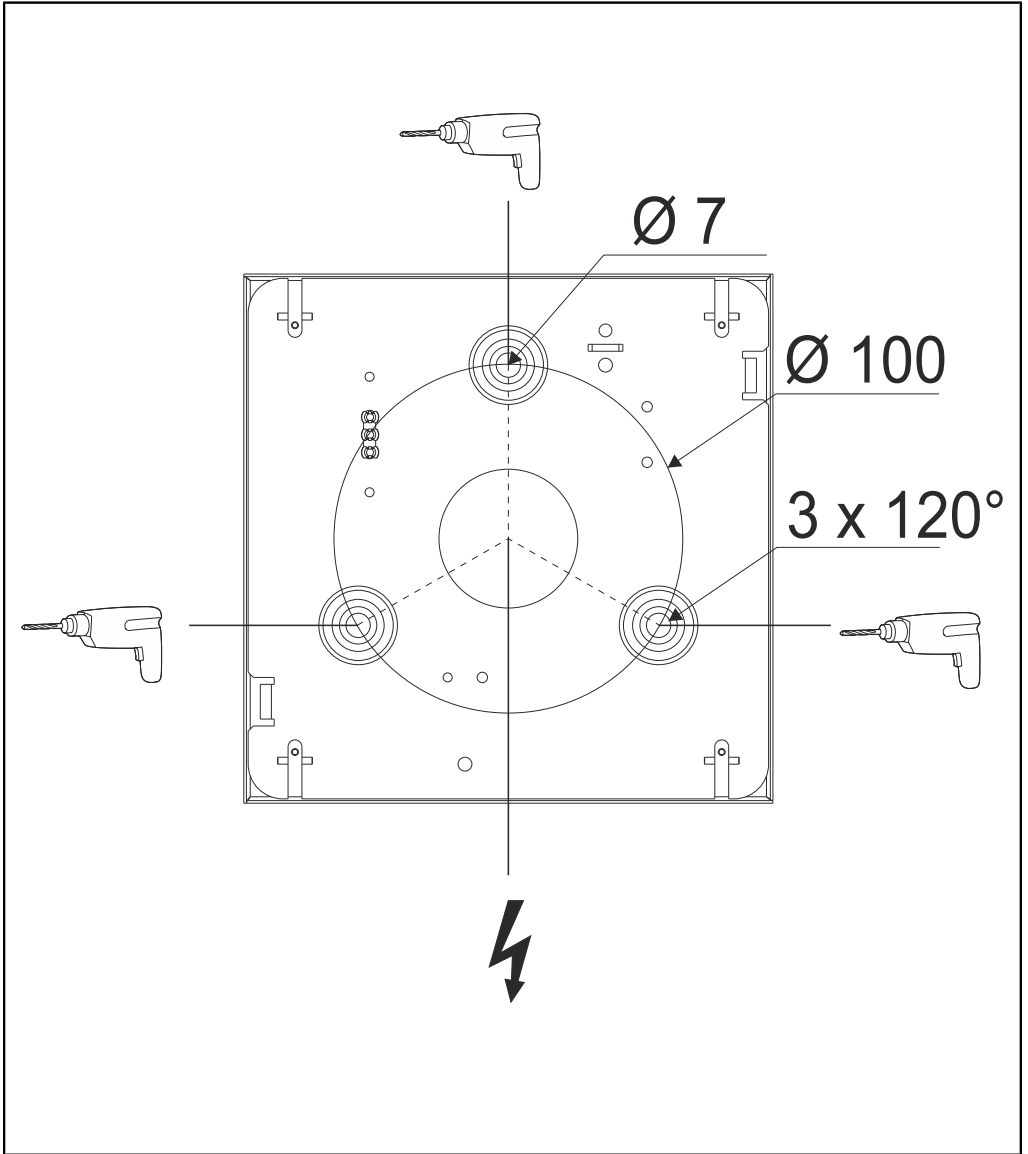

RZB - Rudolf Zimmermann, Bamberg GmbH

🏠 Rheinstraße 16, 96052 Bamberg

☎ 0951/7909-0

📠 0951/7909-198

🌐 [info@rzb-leuchten.de](mailto:info@rzb-leuchten.de)