

INSTRUCTION

Flat Slim Step
312636.002.19

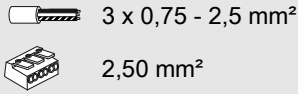

~ 220 - 240 V 50/60 Hz IP 65 IK03



Umgebungstemperatur /
temperature ambiante
=> -20 °C ... + 35 °C

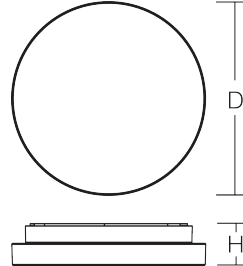

D 450, H 75



4,47 kg



Φ [lm]

P_{LED} [W]

P_{Bulb}

LED

4000

38

1 x 34 W

CCT [K]

CRI

RG

EEK

3000

80

RG 1

D



21 A / 230 μ s



12



20



21



34

$\cos \varphi$

0,99

$f_{\text{min}} - f_{\text{max}}$
[MHz]

13,553 – 13,567

p_{EIRP} [mW]

0

p_{EIRP} [dBm]

4





Installation erfordert
Elektro-Fachkraft!

Symbole nach ISO 7010



Allgemeine Sicherheitshinweise

- Der elektrische Anschluss muss ordnungsgemäß nach geltenden Normen und den nationalen sowie internationalen Sicherheits- und Unfallverhütungsvorschriften erfolgen.
- Beschädigte Leuchten dürfen nicht betrieben werden.
- Keine Haftung für Schäden durch unsachgemäßen Einsatz.
- Bei Instandsetzung nur Originalteile verwenden.
- Tragfähigkeit der Decke und Befestigungselemente sicherstellen.

Betrieb der Leuchte

- Die unzulässigen Umgebungstemperaturen reduzieren die Lebensdauer der Leuchte, im Extremfall droht der Frühausfall.
- Zur Vermeidung von EMV-Problemen die Durchgangsverdrahtung nicht entlang der Leuchtenverdrahtung führen.
- Steuereingänge von dimmbaren Leuchten mit handelsüblichen für Netzspannung geeigneten Leitungen anschließen.

Manipulationen unserer Produkte sind unzulässig

Veränderung, Umarbeitung, Umkennzeichnung von Produkten sowie deren Verpackung sind unzulässig und verletzen u.a. unsere eingetragenen Warenzeichenrechte. Solche Modifikationen können technische Eigenschaften unserer Produkte negativ beeinflussen, diese zerstören und möglicherweise Folgeschäden an anderen Objekten verursachen. Für durch derartige Modifikationen verursachte Schäden kann der Hersteller in keinem Fall verantwortlich gemacht werden.



Installation requires
a qualified electrician!

Symbols according
to ISO 7010



General Safety Information

- Electric connection must be appropriate according to all applicable standards and other national and international safety and accident prevention regulations.
- Damaged luminaires must not be operated.
- No liability is accepted for damages resulting from improper use.
- Use genuine parts only for repair.
- Ensure stability of the ceiling and fastening elements.

Operation of the luminaire

- Exceeding the permissible ambient temperature will reduce the luminaire's lifecycle, resulting in premature failure in extreme cases.
- Avoid ESD problems by not routing feed-through wiring directly along the wiring of the luminaire.
- Connect control inputs of dimmable luminaires with standard cables suitable for power supply voltage.

Manipulation of our products is not permitted

Modifications, reworking, re-labelling of products as well as their package is not permitted and infringes, amongst others, our registered trademark rights. Such modifications may affect technical properties of our products, damage them and possibly cause consequential damage to other objects. The manufacturer shall not be responsible under any circumstances for damage caused by such modifications.



Bei Fragen zu unseren Symbolen, besuchen Sie folgende Webseite:
If you have any questions about our signs, visit the following website:





https://www.rzb.de/fileadmin/assets/downloads/PDF/RZB_Symbolklaerung.pdf

EEK 



Dieses Produkt enthält eine Lichtquelle der Energieeffizienzklasse D entsprechend Verordnung (EU) 2019/2015

This product contains a light source of energy efficiency class D according to regulation (EU) No 2019/2015

 →  Jede zersprungene Schutzabdeckung ist zu ersetzen. DIN EN 60598

 →  Replace any cracked protective shield. IEC DIN EN 60598

Hinweis zum Einsatz von Leuchten mit D - Kennzeichnung nach EN 60598-2-24
Reference for application of lumiaires with D - marking according to EN 60598-2-24

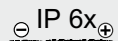
	<u>Umgebung ohne Staubablagerung</u> Environment without dust deposit
	<u>Umgebung mit nicht elektrisch leitender Staubablagerung</u> Environment with non-electrically conductive dust deposit
	<u>Umgebung mit elektrisch leitender Staubablagerung</u> Environment with electrically conductive dust deposit

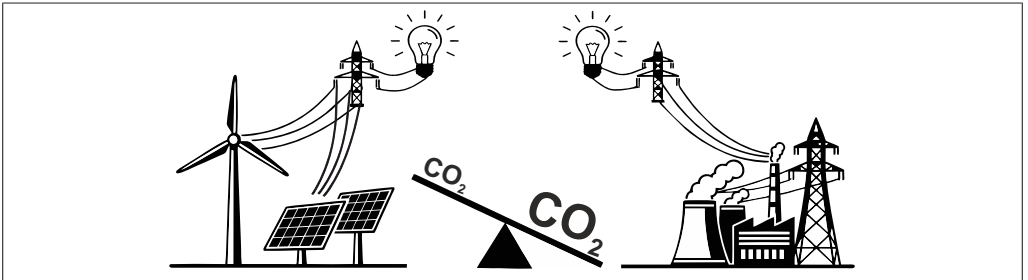

Apply Thinly

Das beigegefügte Schmierfett dient als Montagehilfe und ist nur bei Bedarf zu verwenden. Falls Sie beim Aufschrauben des Glases auf die Armatur einen starken Widerstand spüren, geben Sie eine geringe Menge des Fetts auf die Dichtung.

The enclosed grease serves as an assembly aid and should only be used if necessary. If you feel strong resistance when screwing the glass onto the fitting, apply a small amount of the grease to the gasket.

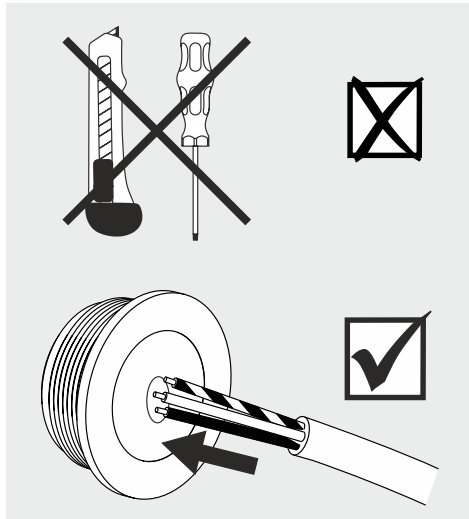
Funktionsparameter: HF-Bewegungsmelder HCD405/BT

- HF-Melder 5,8 GHz ISM Frequenzband
- Haltezeit 4 Sek. - 10 Std.; stufenlos einstellbar
- Erfassungswinkel 30° - 150°
- Reichweite bis Ø8 m; in 5 Stufen einstellbar
- Werkeinstellung: Haltezeit 20 Min., Reichweite ca. Ø8 m
- Dim-Funktion: Soft Start. Korridor, Permanent
- Weitere Funktionen: Profile und Gruppen erstellen, vernetzen der Sensoren
- Master/Slave: bis zu 14 weitere DALI-Leuchten anschließbar

Functional parameters: HF movement sensor HCD405/BT

- HF sensor 5,8 GHz ISM frequency
- Hold time 4 sec. - 10 h; infinitely adjustable
- Detection range 30° - 150°
- Range up to Ø8 m; adjustable 5 levels
- Factory setting: Hold time 20 min., range approx. Ø8 m
- Dim function: Soft start. corridor, permanent
- More functions: Create profiles and groups, connecting the sensors
- Master/Slave: Up to 14 more DALI luminaires can be connected

Ersatzteil
Spare part

2x





SENSORS &
LIGHTING CONTROL

HYTRONIK®

HYTRONIK INDUSTRIAL LIMITED
Floor G, 101, Swire A, 85th, Capital, 1 Wang Kwong Road,
Kowloon Bay, Kowloon, Hongkong
T: 00852-30119325 F: 00852-30116935
E: info@hytronik.com

CHINA FACTORY
3rd Floor, Block C, complex building, 155#, Bai'gang road south,
Bai'gang village, Xiao Jin Kou town, Huicheng district, Huizhou, Guangdong,
T: 86-752-2772020 F: 86-752-2772877
E: info@hytronik.com W: www.hytronik.com

Declaration of Conformity

We, Hytronik Electronics Co., Ltd

3rd Floor, block C, complex building, 155#, Bai'gang road south,

Bai'gang village, Xiao Jin Kou town, Huicheng district, Huizhou, Guangdong, China.

Declare at our sole responsibility, that the devices as following are designed and manufactured is in conformity with the provisions of the following EU Directive(s) and that the standards and /or technical specifications referenced.

Brand:	Hytronik
Product models:	HCD405/BT
Type:	Bluetooth microwave sensor
Relevant EU directives:	2014/53/EU; 2011/65/EU(With amendment EU 2015/863)
Standards complied	EN 60669-1:2018 EN 60669-2-1:2004 /A12:2010 EN IEC 55015:2019 EN 61547:2009 EN IEC 61000-3-2:2019 EN 61000-3-3:2013/A1:2019 EN 300 328 V 2.2.2 EN 300 440 V2.2.1 EN 301 489-1 V2.2.3 EN 301 489-3 V2.1.1 EN 301 489-17 V3.1.1 EN 62479:2010

We declare as the manufacturer that the mentioned above complies with all essential requirements in the way specified and conforms with the type for which is above mentioned, and be affixed the CE-mark on the product or to the packaging and any accompanying documentation.

Jun.15th,2021

(place and date of issue)

(Test Dep. Manager)(Simon Xia)





<https://www.rzb.de/fileadmin/assets/downloads/PDF/Koolmesh-App-Bedienungsanleitung-DE-210115.pdf>

<https://www.rzb.de/fileadmin/assets/downloads/PDF/Koolmesh-App-User-Manual-EN-2.0.pdf>

Bluetooth 5.0 SIG mesh



iOS



Android



for iOS



for Android



EG-Konformitätserklärung
EC-Declaration of Conformity
Déclaration UE de conformité
Declaración de conformidad CE
Deklaracja zgodności UE



Hersteller, Anschrift:
Manufacturer, address:
Fabricant, adresse:
Fabricante, dirección:
Producent, adres:

RZB Rudolf Zimmermann, Bamberg GmbH
Rheinstrasse 16
96052 Bamberg
Deutschland / Germany / Allemagne / Alemania / Niemcy

Wir erklären in alleiniger Verantwortung, dass das Produkt
 We declare under sole responsibility that the product
 Nous déclarons, sous notre propre responsabilité, que le produit
 Declaramos bajo nuestra sola responsabilidad que el producto
 Deklarujemy z pełną odpowiedzialnością, że produkt

Produktbezeichnung:
Product designation: **Flat Slim Step**
Description des produits:
Designación de producto: **312636.002.19**
Oznaczenie produktu:

mit den folgenden EG-Richtlinien und Normen übereinstimmt:
 complies with the following EC Directives and standards:
 est conforme aux normes et directives de l'UE suivantes:
 cumple con las siguientes directivas y normas CE:
 jest zgodny z następującymi dyrektywami UE i normami:

<p>RED Directive 2014/53/EU</p>	<p>(3.1a) EN 60598-1:2021/A11:2022 EN 60598-2-1:1989 EN 62471:2008 EN 62479:2010 EN 62493:2010 (3.1b) EN 301 489-1:V2.2.3 EN 301 489-17:V3.2.4 EN 301 489-3:V2.3.2 EN 55015:2019/A11:2020 EN 61000-3-2:2019/A1:2021 EN 61000-3-3:2013+A1:2019+A2:2021+A2:2021/AC:2022 EN 61547:2023 (3.2) EN 300 328:V2.2.2 EN 300 330:V2.1.1 EN 300 440:V2.1.1</p>
<p>RoHS Directive 2011/65/EU</p>	<p>EN 63000:2018</p>
<p>ErP Directive 2009/125/EC</p>	<p>(EU) 2019/2020</p>

Dokument-Nr. / Document No. / Document No. **24001759**
 Document No. / Nr dokumentu

Aussteller / Issuer / Délivré par: **RZB Rudolf Zimmermann, Bamberg GmbH**
 Otorgante / Wystawca:

Ort, Datum / Place, Date / Lieu, date: **Bamberg, 02.02.2024**
 Lugar, Fecha / Miejsce, data:

Rechtsverbindliche Unterschrift:
 Legally binding signature:
 Signature juridiquement obligatore:
 Firma legalmente vinculante:
 Prawnie wiązacy podpis:

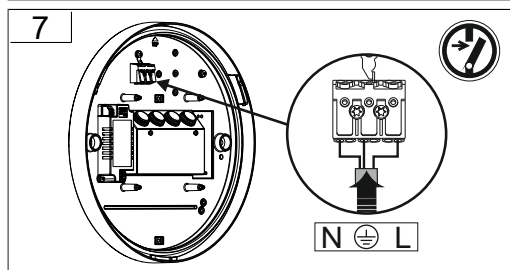
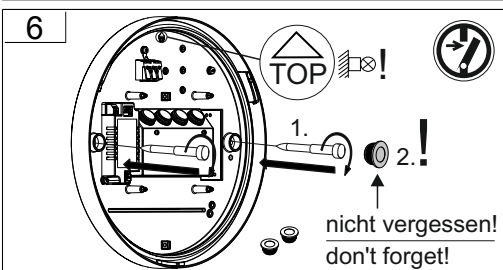
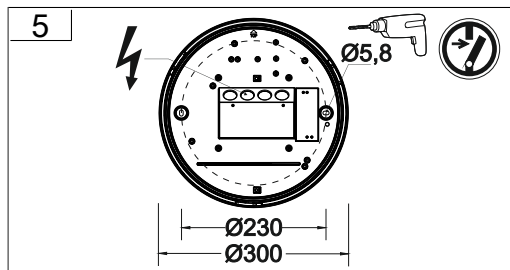
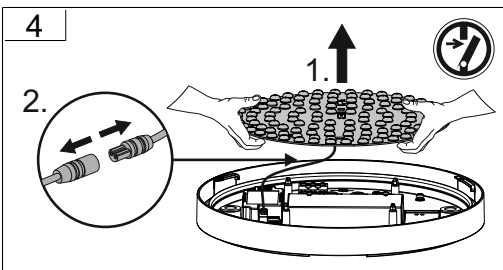
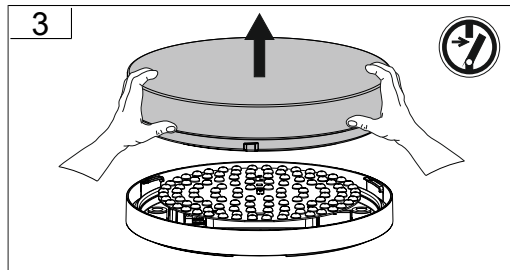
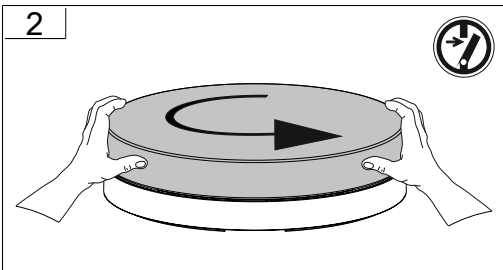
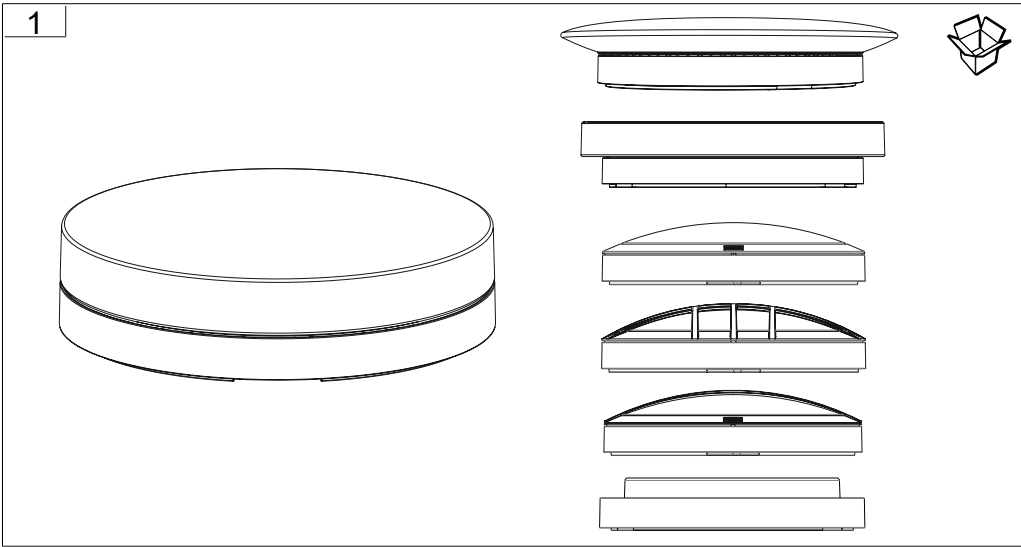
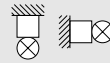

 Reiner Jürgens
 CEO/Direktor Zarządzający/Geschäftsführer

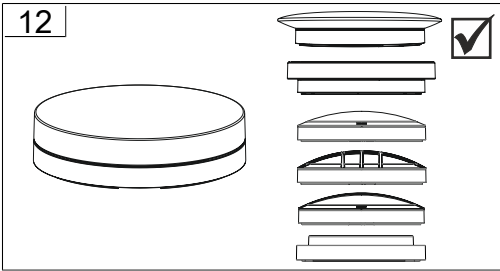
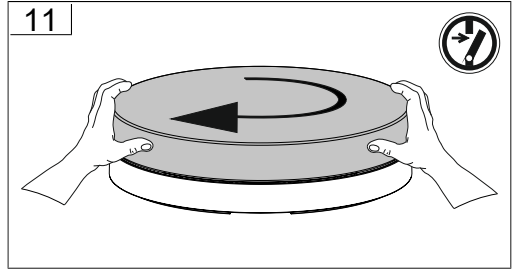
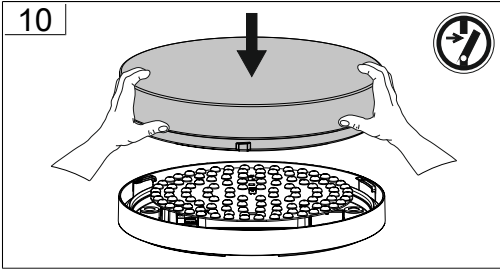
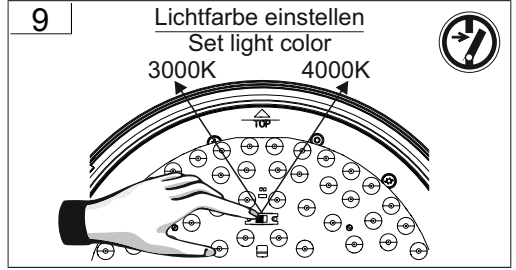
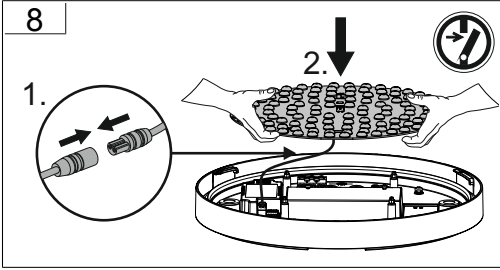
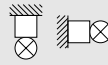

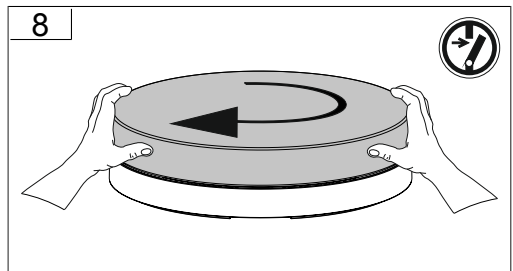
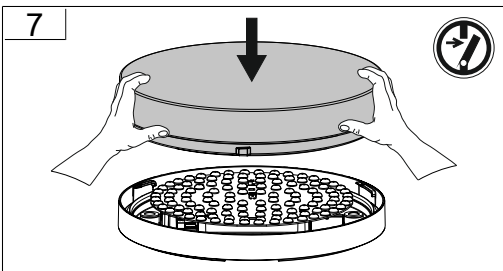
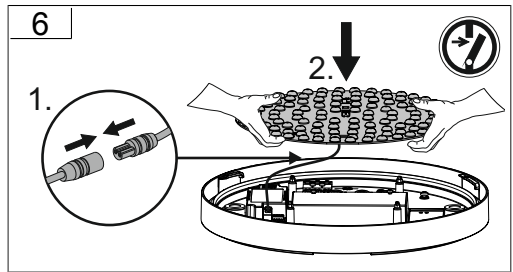
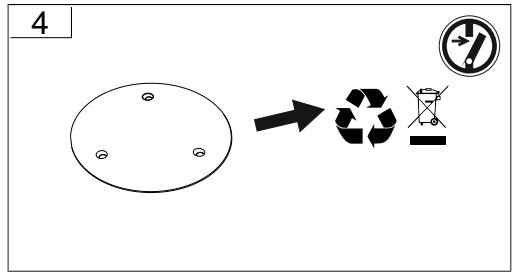
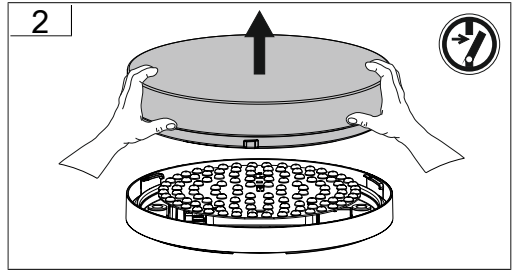

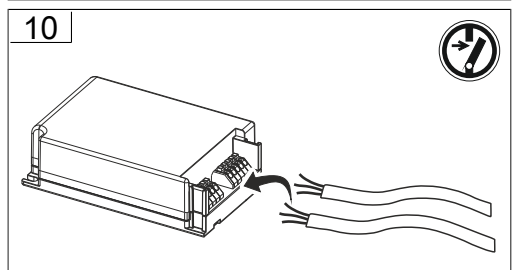
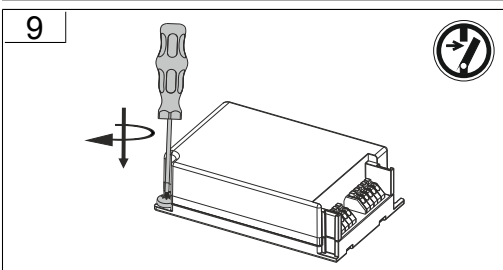
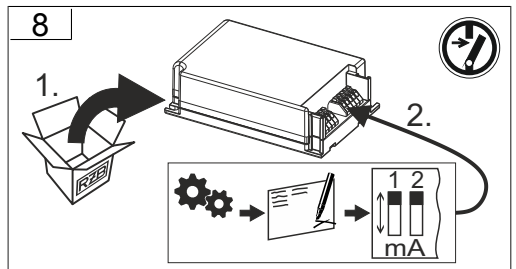
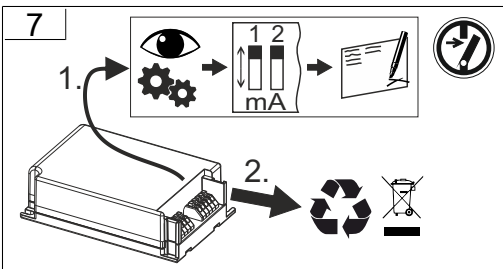
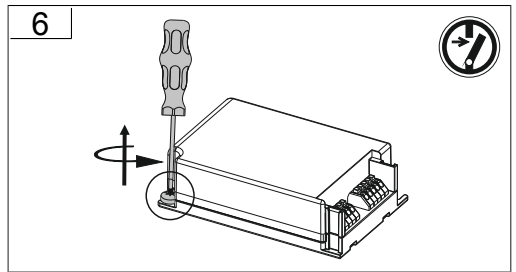
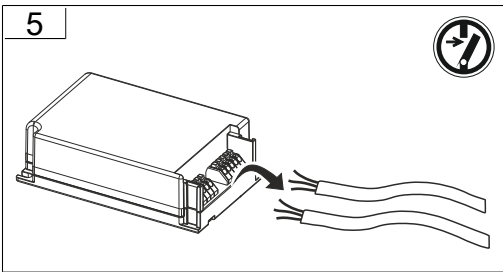
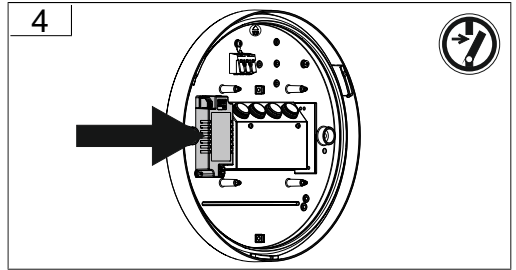
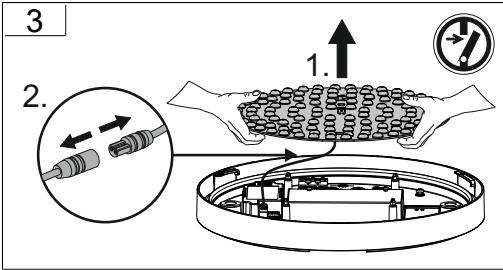
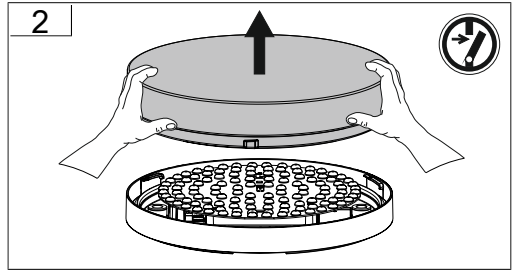
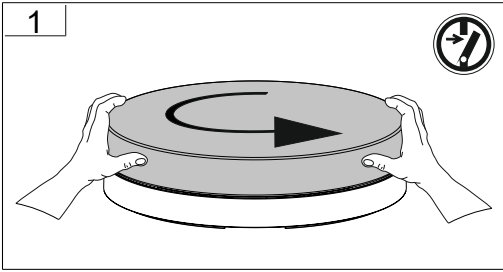

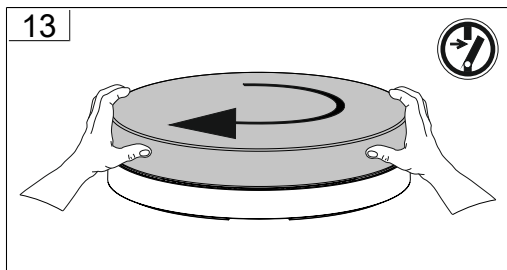
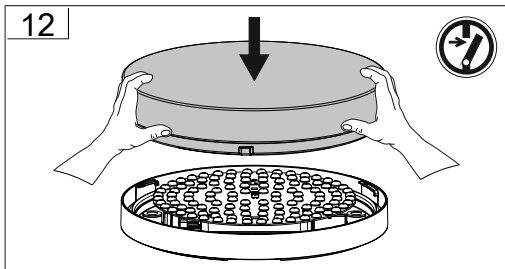
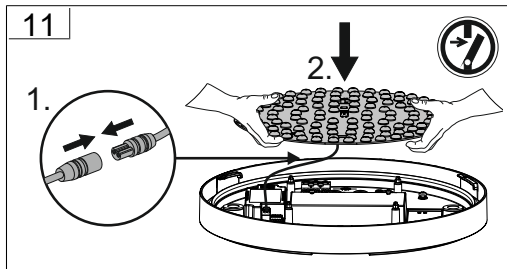



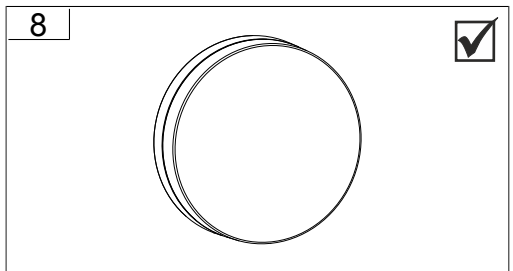
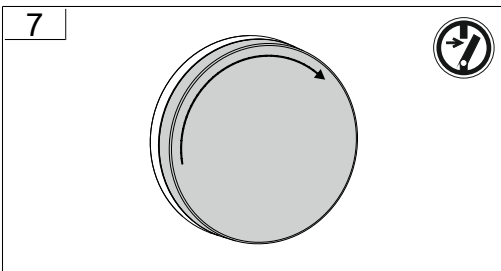
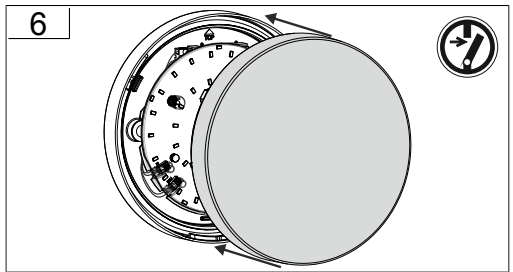
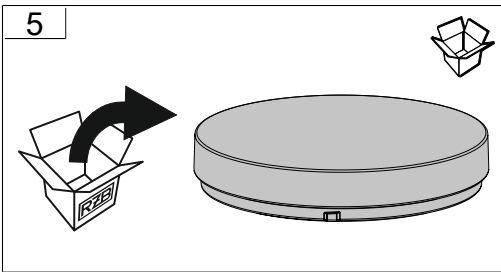
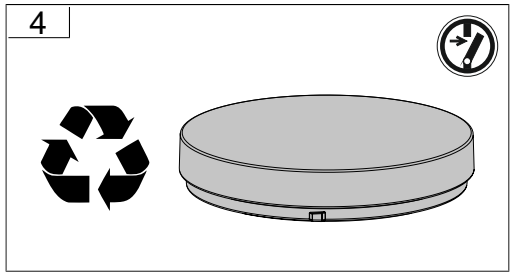
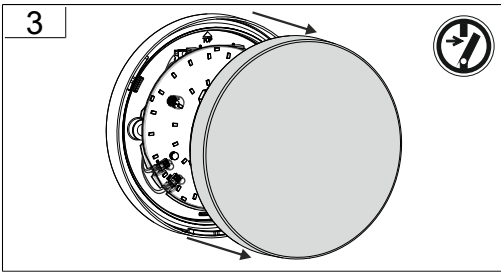
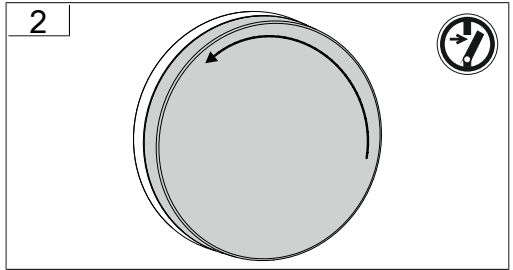
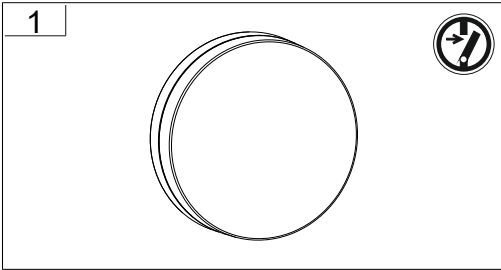

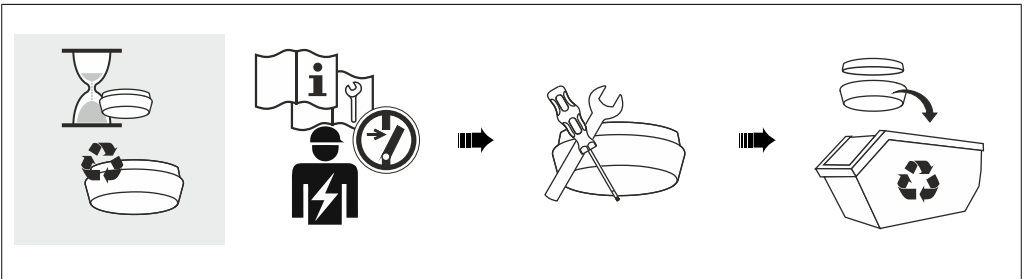
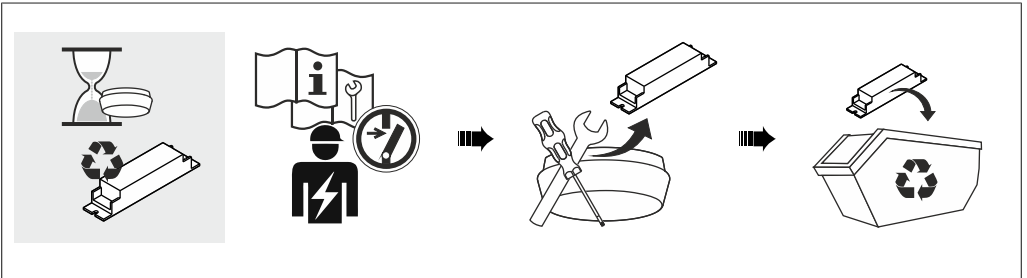
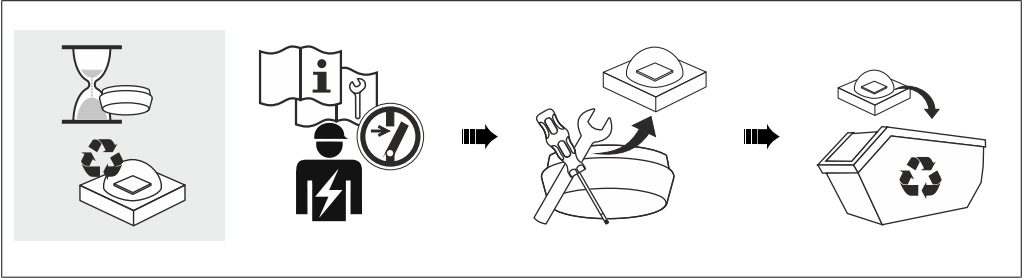







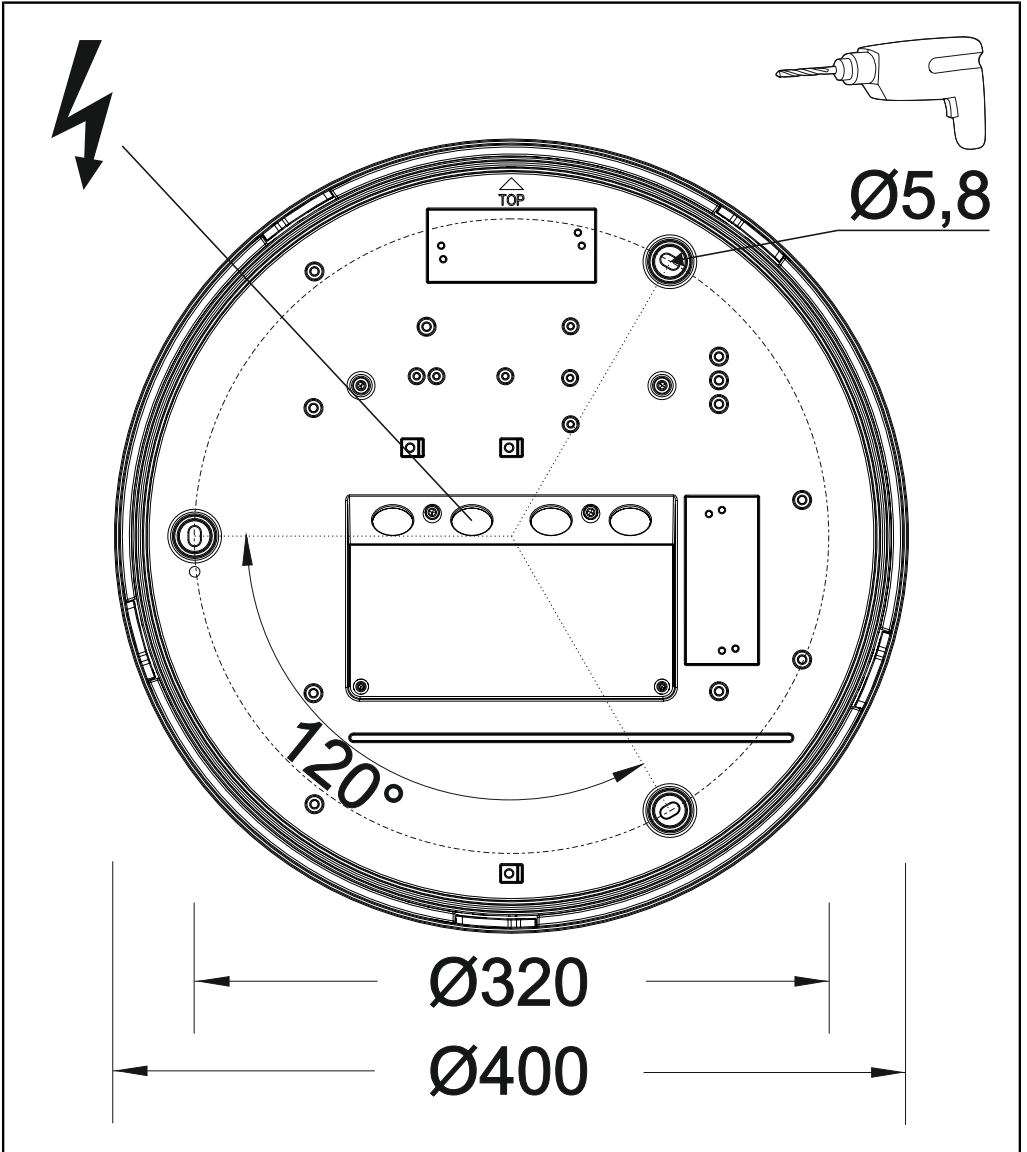

RZB - Rudolf Zimmermann, Bamberg GmbH

Rheinstraße 16, 96052 Bamberg

0951/7909-0

0951/7909-198

info@rzb-leuchten.de