

INSTRUCTION

Flat Slim Step
312680.002.19

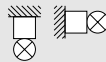

~ 220 - 240 V 50/60 Hz IP 65 IK03



 3 x 0,75 - 2,5 mm²

 2,50 mm²



Umgebungstemperatur /
temperature ambiante
=> -20 °C ... + 35 °C

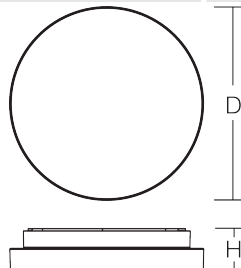

D 450, H 75



4,4 kg



Φ [lm]

P_{LED} [W]

P_{inc}

LED

4000

38

1 x 34 W

CCT [K]

CRI

RG

EEK

3000

80

RG 1

D

I_{max} / $I_{\text{max}}/2$
T50

B10 [St.]

B16 [St.]

C10 [St.]

C16 [St.]

$\cos \varphi$

5 A / 50 μ s

31

50

52

85

0,95

$f_{\text{min}} - f_{\text{max}}$
[MHz]

p_{EIRP} [mW]

5725 - 5875

0,2

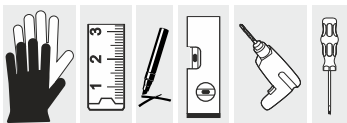



Installation erfordert
Elektro-Fachkraft!

Symbole nach ISO 7010



Allgemeine Sicherheitshinweise

- Der elektrische Anschluss muss ordnungsgemäß nach geltenden Normen und den nationalen sowie internationalen Sicherheits- und Unfallverhütungsvorschriften erfolgen.
- Beschädigte Leuchten dürfen nicht betrieben werden.
- Keine Haftung für Schäden durch unsachgemäßen Einsatz.
- Bei Instandsetzung nur Originalteile verwenden.
- Tragfähigkeit der Decke und Befestigungselemente sicherstellen.

Betrieb der Leuchte

- Die unzulässigen Umgebungstemperaturen reduzieren die Lebensdauer der Leuchte, im Extremfall droht der Frühausfall.
- Zur Vermeidung von EMV-Problemen die Durchgangsverdrahtung nicht entlang der Leuchtenverdrahtung führen.
- Steuereingänge von dimmbaren Leuchten mit handelsüblichen für Netzspannung geeigneten Leitungen anschließen.

Manipulationen unserer Produkte sind unzulässig

Veränderung, Umarbeitung, Umkennzeichnung von Produkten sowie deren Verpackung sind unzulässig und verletzen u.a. unsere eingetragenen Warenzeichenrechte. Solche Modifikationen können technische Eigenschaften unserer Produkte negativ beeinflussen, diese zerstören und möglicherweise Folgeschäden an anderen Objekten verursachen. Für durch derartige Modifikationen verursachte Schäden kann der Hersteller in keinem Fall verantwortlich gemacht werden.



Installation requires
a qualified electrician!

Symbols according
to ISO 7010



General Safety Information

- Electric connection must be appropriate according to all applicable standards and other national and international safety and accident prevention regulations.
- Damaged luminaires must not be operated.
- No liability is accepted for damages resulting from improper use.
- Use genuine parts only for repair.
- Ensure stability of the ceiling and fastening elements.

Operation of the luminaire

- Exceeding the permissible ambient temperature will reduce the luminaire's lifecycle, resulting in premature failure in extreme cases.
- Avoid ESD problems by not routing feed-through wiring directly along the wiring of the luminaire.
- Connect control inputs of dimmable luminaires with standard cables suitable for power supply voltage.

Manipulation of our products is not permitted

Modifications, reworking, re-labelling of products as well as their package is not permitted and infringes, amongst others, our registered trademark rights. Such modifications may affect technical properties of our products, damage them and possibly cause consequential damage to other objects. The manufacturer shall not be responsible under any circumstances for damage caused by such modifications.



Bei Fragen zu unseren Symbolen, besuchen Sie folgende Webseite:
 If you have any questions about our signs, visit the following website:





https://www.rzb.de/fileadmin/assets/downloads/PDF/RZB_Symbolklaerung.pdf

EEK 



Dieses Produkt enthält eine Lichtquelle der Energieeffizienzklasse D entsprechend Verordnung (EU) 2019/2015

This product contains a light source of energy efficiency class D according to regulation (EU) No 2019/2015

 →  Jede zersprungene Schutzabdeckung ist zu ersetzen. DIN EN 60598

 →  Replace any cracked protective shield. IEC DIN EN 60598

Hinweis zum Einsatz von Leuchten mit D - Kennzeichnung nach EN 60598-2-24
 Reference for application of lumiaires with D - marking according to EN 60598-2-24

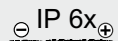
	<u>Umgebung ohne Staubablagerung</u> Environment without dust deposit
	<u>Umgebung mit nicht elektrisch leitender Staubablagerung</u> Environment with non-electrically conductive dust deposit
	<u>Umgebung mit elektrisch leitender Staubablagerung</u> Environment with electrically conductive dust deposit

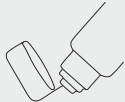
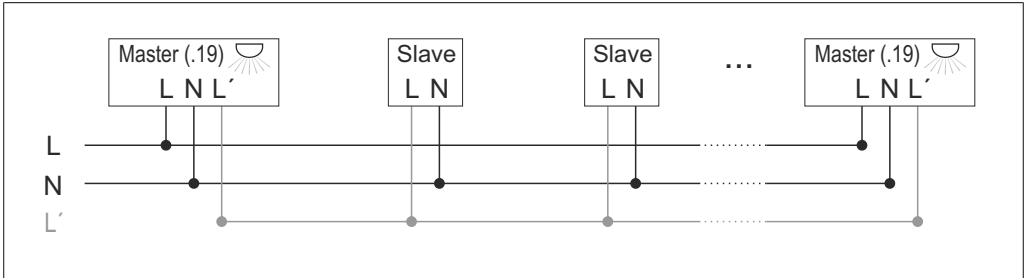

Apply Thinly

Das beigegefügte Schmierfett dient als Montagehilfe und ist nur bei Bedarf zu verwenden. Falls Sie beim Aufschrauben des Glases auf die Armatur einen starken Widerstand spüren, geben Sie eine geringe Menge des Fetts auf die Dichtung.

The enclosed grease serves as an assembly aid and should only be used if necessary. If you feel strong resistance when screwing the glass onto the fitting, apply a small amount of the grease to the gasket.

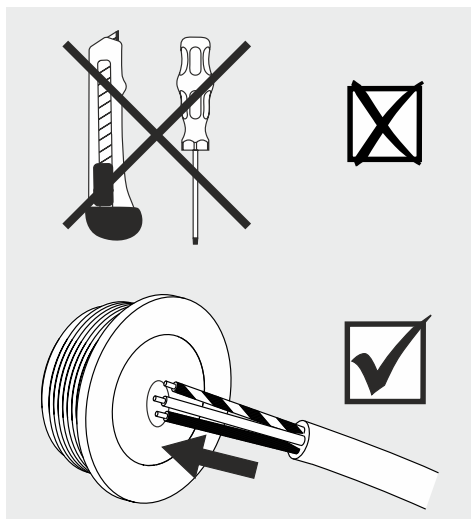



DIP-Schalter-Einstellungen / DIP Switch Settings

1 Erfassungsbereich / Detection Range

Die Sensorempfindlichkeit kann durch Auswahl der Kombination an den DIP-Schaltern genau auf die jeweilige Anwendung eingestellt werden.

The sensor sensitivity can be adjusted by selecting the combination at the DIP switches to exactly match the respective application by selecting the combination on the DIP switches.

	1	2	
I	●	●	100%
II	●	○	75%
III	○	●	50%
IV	○	○	10%

	I – 100%
	II – 75%
	III – 50%
	IV – 10%

2 Haltezeit / Hold Time

Wählen Sie den DIP-Schalter für die Einschaltzeit des Lichts nach der Anwesenheit-Erkennung. Diese Funktion ist deaktiviert, wenn das natürliche Licht ausreicht.

Select the DIP switch configuration for the light on-time after presence detection. This function is disabled when natural light is sufficient.

	3	4	
I	●	●	5s
II	●	○	90s
III	○	●	5min
IV	○	○	15min

	I – 5s
	II – 90s
	III – 5min
	IV – 15min

3 Tageslicht-Schwellenwert / Daylight Threshold

Stellen Sie den Pegel entsprechend der Beschaffenheit und der Umgebung ein. Das Licht schaltet sich nicht ein, wenn die Umgebungshelligkeit den eingestellten Schwellenwert für Tageslicht überschreitet. Bitte beachten Sie, dass sich die Umgebungsluxwerte auf das interne Licht beziehen, das den Sensor erreicht. Durch die Deaktivierung des Tageslichtsensors wird der Sensor in den Modus versetzt.

Set the level according to the fixture and environment. The light will not turn on if ambient lux level exceeds the daylight threshold preset. Please note that the ambient lux level refers to internal light reaching the sensor. Disabling the daylight sensor will put the sensor into occupancy detection only mode.

	5	6	
I	●	●	Disabl
II	●	○	50Lux
III	○	●	10Lux
IV	○	○	2Lux

	I – Disable
	II – 50 Lux
	III – 10 Lux
	IV – 2 Lux

Ersatzteil
Spare part

2x





EG-Konformitätserklärung
EC-Declaration of Conformity
Déclaration UE de conformité
Declaración de conformidad CE
Deklaracja zgodności UE



Hersteller, Anschrift:
Manufacturer, address:
Fabricant, adresse:
Fabricante, dirección:
Producent, adres:

RZB Rudolf Zimmermann, Bamberg GmbH
Rheinstrasse 16
96052 Bamberg
Deutschland / Germany / Allemagne / Alemania / Niemcy

Wir erklären in alleiniger Verantwortung, dass das Produkt
We declare under sole responsibility that the product
Nous déclarons, sous notre propre responsabilité, que le produit
Declaramos bajo nuestra sola responsabilidad que el producto
Deklarujemy z pełną odpowiedzialnością, że produkt

Produktbezeichnung:
Product designation: **Flat Slim Step**
Description des produits:
Designación de producto: **312680.002.19**
Oznaczenie produktu:

mit den folgenden EG-Richtlinien und Normen übereinstimmt:
complies with the following EC Directives and standards:
est conforme aux normes et directives de l'UE suivantes:
cumple con las siguientes directivas y normas CE:
jest zgodny z następującymi dyrektywami UE i normami:

<p>RED Directive 2014/53/EU</p>	<p>(3.1a) EN 50663:2017 EN 60598-1:2021/A11:2022 EN 60598-2-1:1989 EN 62471:2008 EN 62493:2010 (3.1b) EN 301 489-1:V2.2.3 EN 301 489-3:V2.3.2 EN 55015:2019/A11:2020 EN 61000-3-2:2019/A1:2021 EN 61000-3-3:2013+A1:2019+A2:2021+A2:2021/AC:2022 EN 61547:2023 (3.2) EN 300 440:V2.1.1</p>
<p>RoHS Directive 2011/65/EU</p>	<p>EN 63000:2018</p>
<p>ErP Directive 2009/125/EC</p>	<p>(EU) 2019/2020</p>

Dokument-Nr. / Document No. / Document No. **24001978**
Document No. / Nr dokumentu

Aussteller / Issuer / Délivré par: **RZB Rudolf Zimmermann, Bamberg GmbH**
Otorgante / Wystawca:

Ort, Datum / Place, Date / Lieu, date: **Bamberg, 02.02.2024**
Lugar, Fecha / Miejsce, data:

Rechtsverbindliche Unterschrift:
Legally binding signature:
Signature juridiquement obligatore:
Firma legalmente vinculante:
Prawnie wiązacy podpis:

Reiner Jürgens
CEO/Direktor Zarządzający/Geschäftsführer

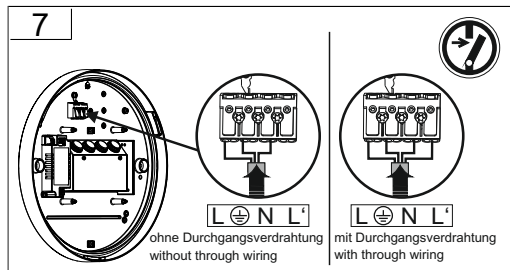
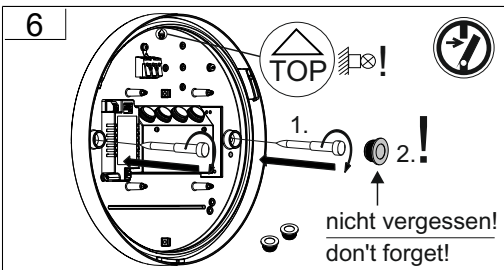
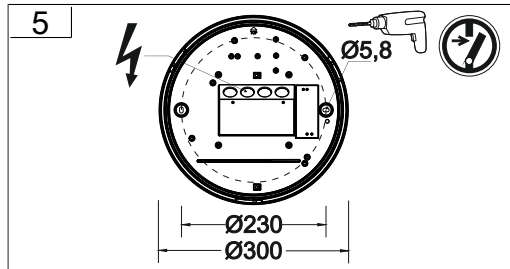
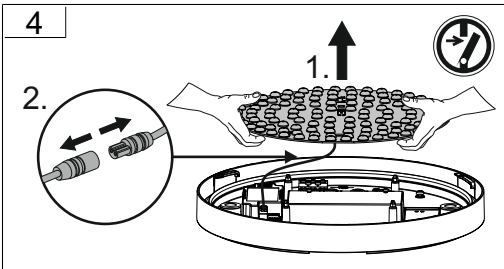
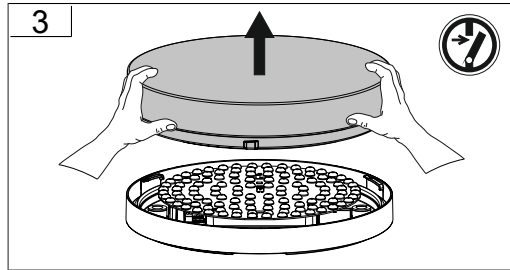
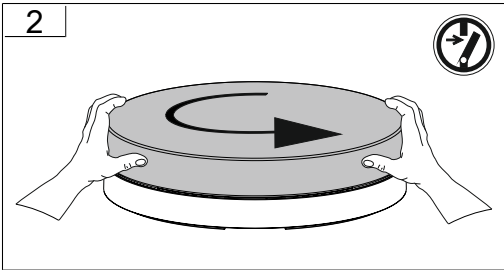
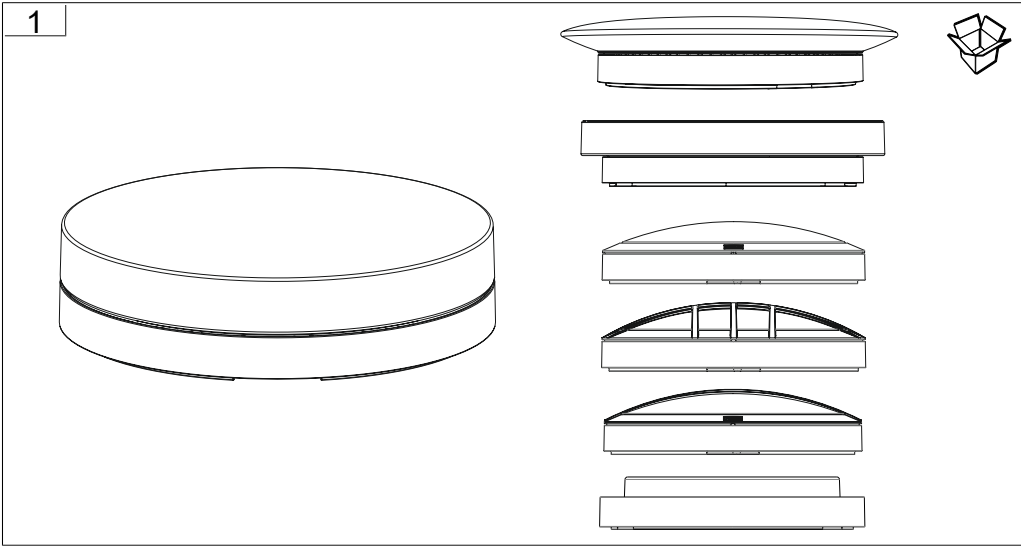



8

Konvertereinstellung / Converter setting

Iout	Pomax	1	2	3	4	
300 mA	13 W	-	-	-	-	
350 mA	15 W	-	-	-	on	
400 mA	17 W	-	-	on	-	
450 mA	19 W	-	-	on	on	
500 mA	22 W	-	on	-	-	
550 mA	24 W	-	on	-	on	
600 mA	26 W	-	on	on	-	3000K → 2450lm
650 mA	28 W	-	on	on	on	4000K → 2550lm
700 mA	30 W	on	-	-	-	
750 mA	32 W	on	-	-	on	
800 mA	33 W	on	-	on	-	
850 mA	35 W	on	-	on	on	
900 mA	38 W	on	on	-	-	
950 mA	40 W	on	on	-	on	
1000 mA	40 W	on	on	on	-	3000K → 4000lm
1050 mA	40 W	on	on	on	on	4000K → 4150lm

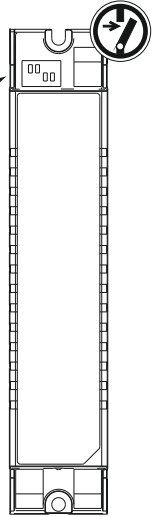

9

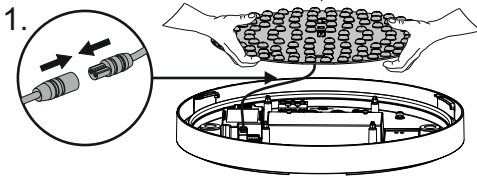

10

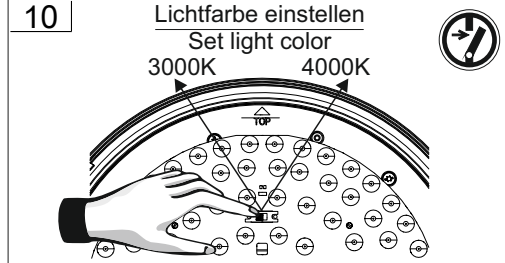

11

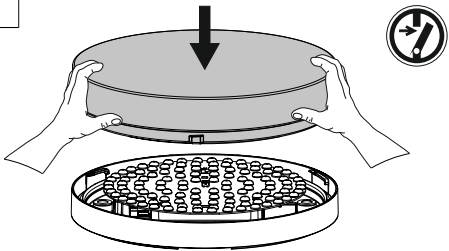

12

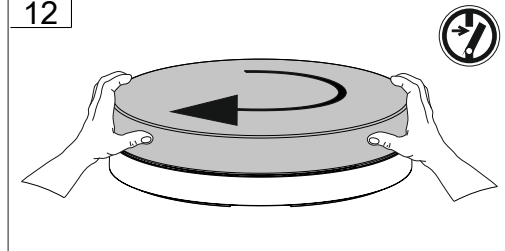

13

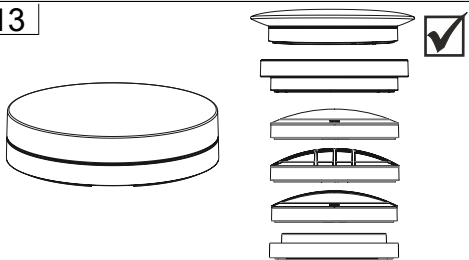



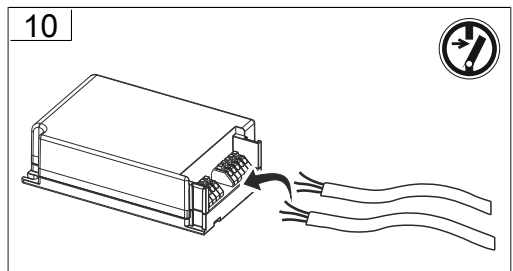
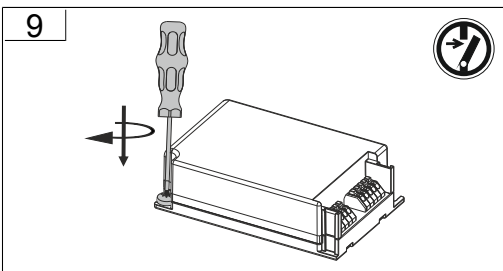
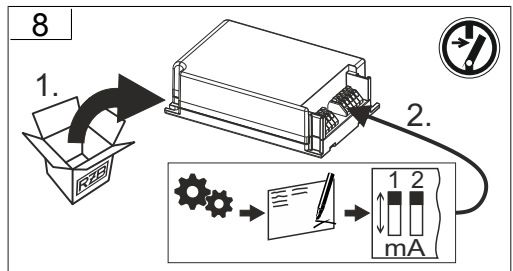
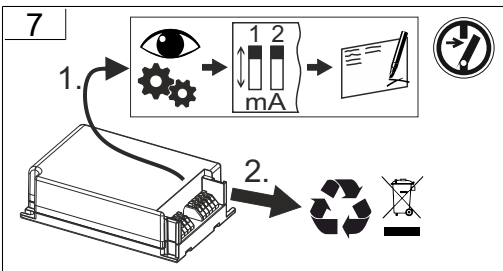
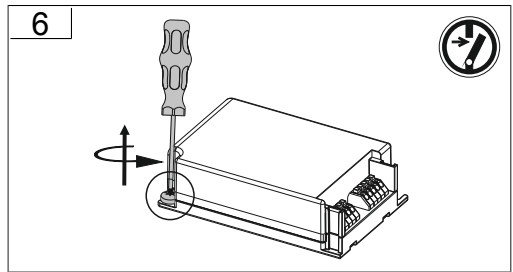
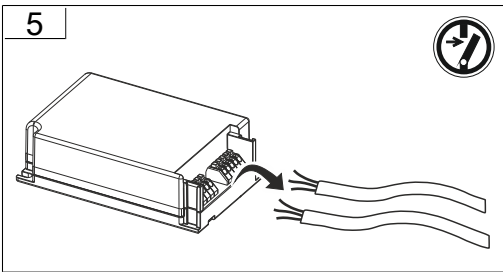
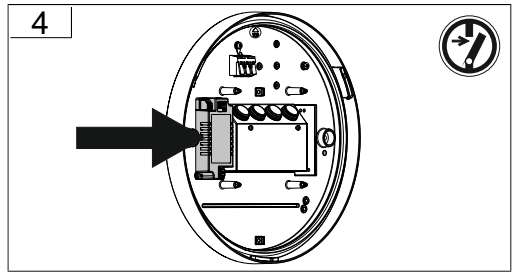
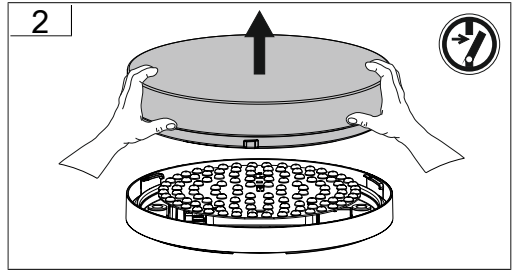

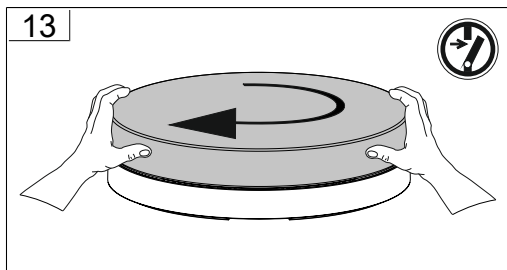
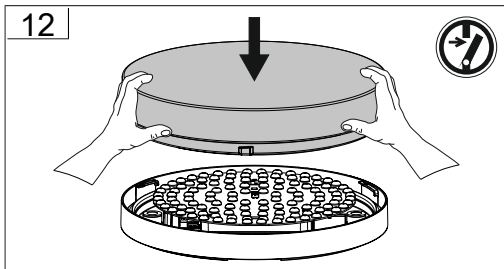
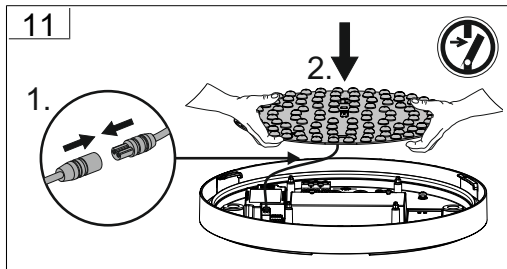

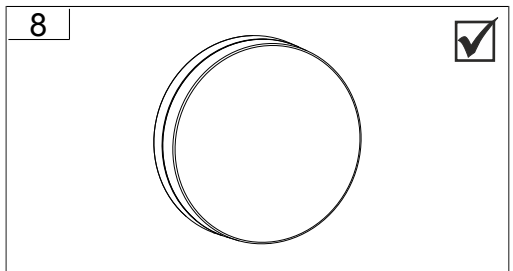
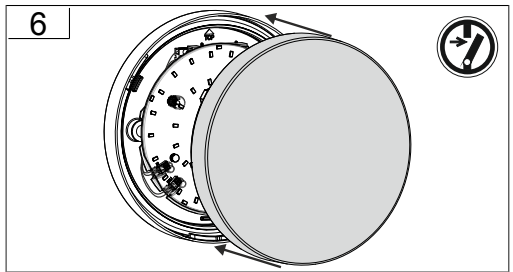
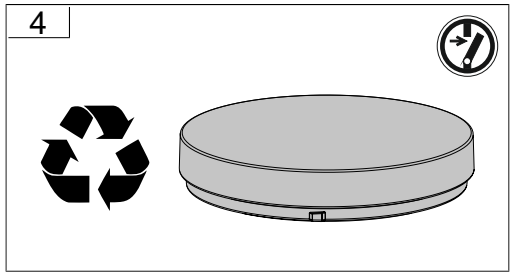

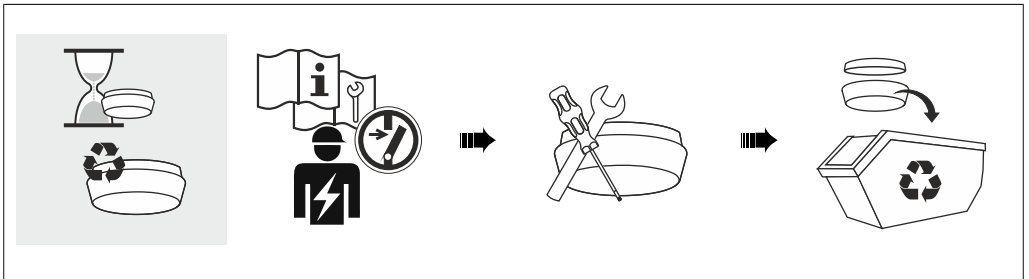
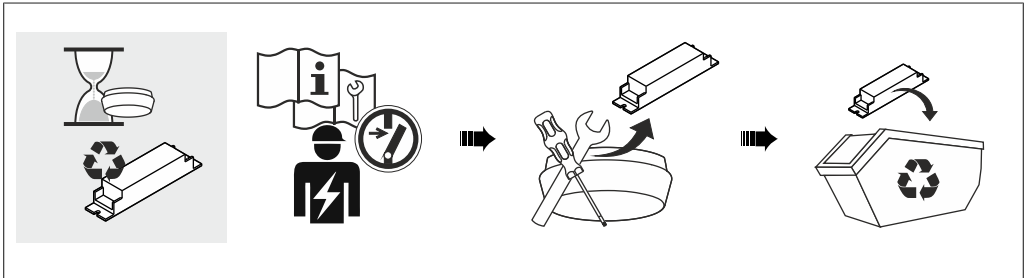
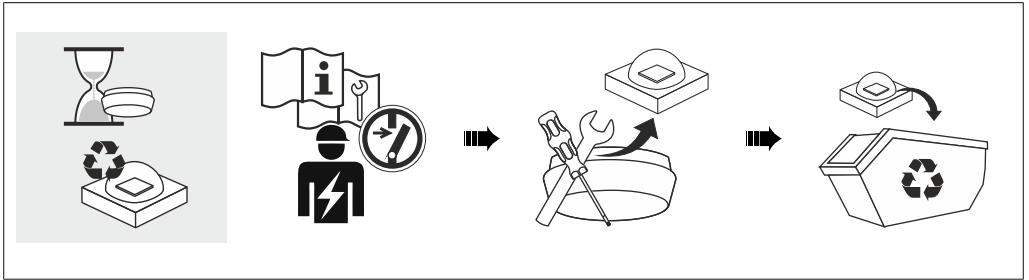

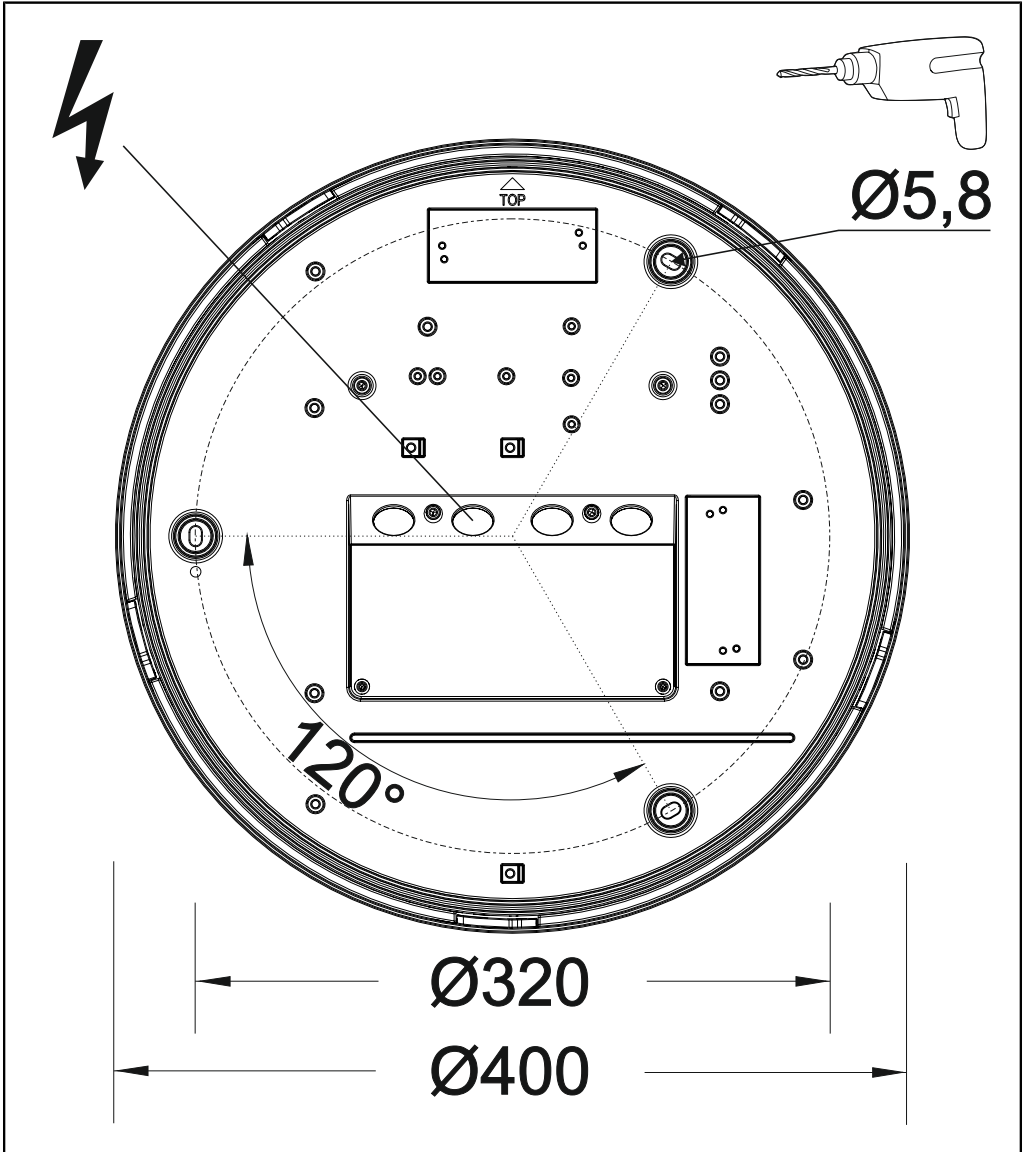

RZB - Rudolf Zimmermann, Bamberg GmbH

🏠 Rheinstraße 16, 96052 Bamberg

☎ 0951/7909-0

📠 0951/7909-198

🌐 info@rzb-leuchten.de