

# BEAMLINE

LUMINARIAS EMPOTRADAS, DE SUPERFICIE Y SUSPENSIÓN

# BEAMLINE

Luminarias empotradas, de superficie y suspensión

## NUEVA PAUTA A SEGUIR EN ESTÉTICA Y CALIDAD DE LA LUZ

¿Una luz potente pero a su vez suave como la seda, con un asombroso confort visual y prácticamente „invisible“ ...? Puede sonar a magia, pero es conocimiento. Este sistema lineal ultra elegante, con una combinación de tecnología y diseño, sigue la tendencia actual de hacer invisibles las luminarias.

La parte técnica de la luminaria se centra en el LED y nuestro nuevo desarrollo **MRS (Mini-Reflektor-System)** con marco antideslumbrante prismático. Gracias a la posibilidad de poder elegir la distribución de la luz, el paquete lumínico y la temperatura de color, LESS IS MORE BEAMLINE se convierte en una herramienta de iluminación configurable muy flexible. Su cuerpo de aluminio sencillo y esbelto la convierte al mismo tiempo en un elemento de diseño. Así surge una unión ejemplar entre estilo y utilidad con la que influir por completo en el ambiente de los espacios. Un reclamo con acción y reacción en cuanto a estética y calidad de luz, ya sea como línea infinita, suspendida en solitario o incluso en su variante de mayor sutileza BEAMLINE SLIM.

A propósito de reclamos: el diseño sencillo y vistoso le puede parecer conocido ... LESS IS MORE BEAMLINE ha sido desarrollada sobre la base de nuestro superventas LESS IS MORE 50 y le hace un homenaje llevándolo en su nombre. La configuración y planificación de la luminaria tienen lugar con una gran facilidad de la mano de LOUI, nuestro configurador extraordinariamente fácil de usar.

## PUNTOS FUERTES

- ⊕ Integración perfecta de la luz en entornos arquitecturales
- ⊕ **Tecnología MRS:** sistema de mini reflectores hechos de termoplástico metalizado con marco antideslumbrante prismático negro, para una iluminación agradable sin deslumbramiento (UGR < 10)
- ⊕ Disponible en tres haces de luz (intensivo, medio o extensivo) que permite un uso flexible
- ⊕ Efecto darklight
- ⊕ **Índice de reproducción cromática: Ra ≥ 90**
- ⊕ Módulo LED sustituible
- ⊕ Instalación sencilla mediante sistema Plug & Play





# LESS IS MORE® BEAMLINE

Luminarias empotradas, de superficie, suspensión y líneas continuas



**Luminarias empotrables**  
Página 8-9



**Luminarias de superficie**  
Página 10-11



**Luminarias de suspensión**  
Página 12-15

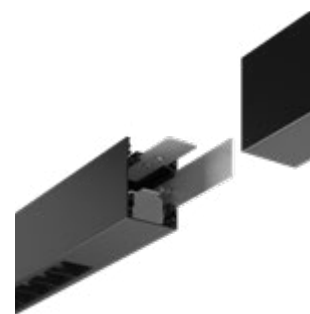

**Líneas continuas**  
Página 18-23

# BEAMLINE SLIM

Luminarias empotrables



# LESS IS MORE® BEAMLINE

Tecnología

Montaje en techo con abrazadera de sujeción SBS premontada

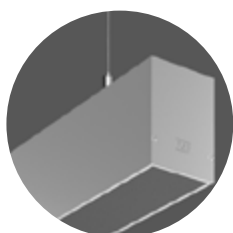

Cable de suspensión de acero, fijación en 2 puntos, posicionamiento variable y regulación continua de la distancia

Carcasa de perfil de aluminio extruido, revestido al polvo

Cada módulo LED se compone de 7 mini reflectores

Módulo LED sustituible y extraíble con equipo integrado



Instalación muy sencilla gracias a la conexión plug & play

Tapas finales de aluminio revestido al polvo

Módulo LED con tecnología MRS: sistema de mini reflectores hechos de termoplástico metalizado con marco antideslumbrante prismático negro, para una iluminación agradable sin deslumbramiento (UGR < 10)

La reproducción del color **Ra 90** para una percepción realista



# LESS IS MORE® BEAMLINE

Todo de un vistazo

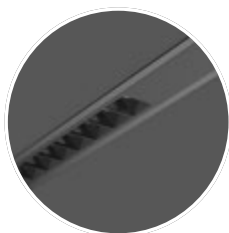

## 3 LONGITUDES

- » con 2 módulos LED (1141 / 1127 mm)
- » con 3 módulos LED (1701 / 1687 mm)
- » con 4 módulos LED (2256 / 2242 mm)



## 3 DISTRIBUCIONES DE LA LUZ

- » haz intensivo
- » haz medio
- » haz extensivo



## 2 EMISIONES POSIBLES

- » directa
- » directa/indirecta

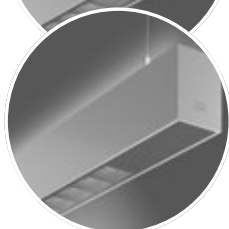

## 4 COLORES

- » blanco con marco antideslumbrante negro
- » plata con marco antideslumbrante negro
- » negro con marco antideslumbrante negro
- » blanco con marco antideslumbrante blanco (Less is more BeamLine - System)

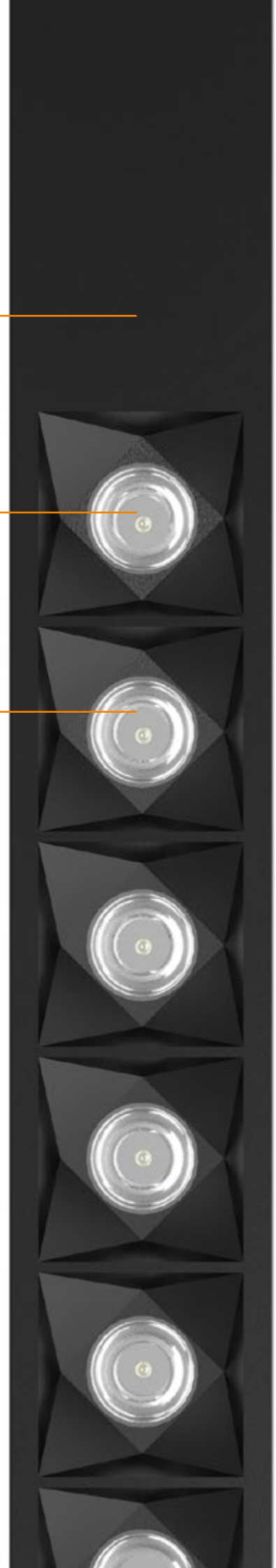





## DATOS FOTOMÉTRICOS

- ⊕ Tecnología MRS para una iluminación agradable sin delumbramiento ( $UGR < 10$ )
- ⊕ Disponible en tres haces de luz (intensivo, medio o extensivo) que permite un uso flexible
- ⊕ Efecto darklight
- ⊕ Iluminación directa/indirecta (luminarias de suspensión)
- ⊕ Índice de reproducción cromática:  $Ra \geq 90$
- ⊕ Vida útil de LED: aprox. 50.000 h (L80/B10)
- ⊕ Tolerancias cromáticas mínimas, triple MacAdam (3 SDCM)

# LESS IS MORE® BEAMLINE

## Descripción del producto | Luminarias empotrables en techo

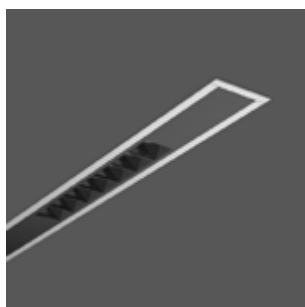

### Luminarias empotrables en techo | Less is more BeamLine

Tipo de Protección: IP 20  
 Clase de Protección: I  
 Espesor de techo S: 10-30 mm  
 Protección contra golpes: IK03

Carcasa de perfil de aluminio extruido, revestido al polvo. Tapas finales de aluminio revestido al polvo. Módulo LED con **tecnología MRS**: sistema de mini reflectores hechos de termoplástico metalizado con marco antideslumbrante prismático negro, para una iluminación agradable sin deslumbramiento (UGR < 10). Cada módulo LED se compone de 7 mini reflectores. Disponible en tres haces de luz (intensivo, medio o extensivo) que permite un uso flexible. Montaje en techo con abrazadera de sujeción SBS premontada. Módulo LED sustituible y extraíble con equipo integrado. Colores disponibles (X): 2 = blanco, 3 = negro, 45 = blanco aluminio

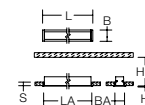

### Luminaria con 2 módulos LED

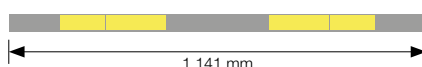

Nº artículo	Dimensiones [mm]	Fuente de luz	Color de la luz	Flujo luminoso de la luminaria [lm]	Potencia luminaria [W]	UGR	Regulación
<b>Luminarias empotrables en techo</b>							
<b>Categoría de Precios 21</b>							
<b>Luminaria con 2 módulos LED - LA 1128 x BA 60 mm, HE 125 mm</b>							
<b>Haz intensivo 10°</b>							
	312465.00X	L 1141, B 71, H 2	LED	930	2050	23	0,7 on/off
	312465.00X.76	L 1141, B 71, H 2	LED	930	2050	23	0,7 DALI
	312465.00X.1	L 1141, B 71, H 2	LED	940	2200	23	0,9 on/off
	312465.00X.1.76	L 1141, B 71, H 2	LED	940	2200	23	0,9 DALI
<hr/>							
	312468.00X	L 1141, B 71, H 2	LED	930	3600	48	2,6 on/off
	312468.00X.76	L 1141, B 71, H 2	LED	930	3600	48	2,6 DALI
	312468.00X.1	L 1141, B 71, H 2	LED	940	3900	48	2,9 on/off
	312468.00X.1.76	L 1141, B 71, H 2	LED	940	3900	48	2,9 DALI
<hr/>							
<b>Haz medio 30°</b>							
	312466.00X	L 1141, B 71, H 2	LED	930	1950	23	1,4 on/off
	312466.00X.76	L 1141, B 71, H 2	LED	930	1950	23	1,4 DALI
	312466.00X.1	L 1141, B 71, H 2	LED	940	2100	23	1,7 on/off
	312466.00X.1.76	L 1141, B 71, H 2	LED	940	2100	23	1,7 DALI
<hr/>							
	312469.00X	L 1141, B 71, H 2	LED	930	3500	48	3,4 on/off
	312469.00X.76	L 1141, B 71, H 2	LED	930	3500	48	3,4 DALI
	312469.00X.1	L 1141, B 71, H 2	LED	940	3800	48	3,7 on/off
	312469.00X.1.76	L 1141, B 71, H 2	LED	940	3800	48	3,7 DALI
<hr/>							
<b>Haz extensivo 50°</b>							
	312467.00X	L 1141, B 71, H 2	LED	930	2050	23	3,5 on/off
	312467.00X.76	L 1141, B 71, H 2	LED	930	2050	23	3,5 DALI
	312467.00X.1	L 1141, B 71, H 2	LED	940	2200	23	3,8 on/off
	312467.00X.1.76	L 1141, B 71, H 2	LED	940	2200	23	3,8 DALI
<hr/>							
	312470.00X	L 1141, B 71, H 2	LED	930	3650	48	5,5 on/off
	312470.00X.76	L 1141, B 71, H 2	LED	930	3650	48	5,5 DALI
	312470.00X.1	L 1141, B 71, H 2	LED	940	3950	48	5,8 on/off
	312470.00X.1.76	L 1141, B 71, H 2	LED	940	3950	48	5,8 DALI

### Luminaria con 3 módulos LED

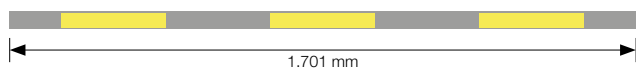

Nº artículo	Dimensiones [mm]	Fuente de luz	Color de la luz	Flujo luminoso de la luminaria [lm]	Potencia luminaria [W]	UGR	Regulación
<b>Luminarias empotrables en techo y pared</b>							
<b>Luminaria con 3 módulos LED - LA 1688 x BA 60 mm, HE 125 mm</b>							
<b>Haz intensivo 10°</b>							
312471.00X	L 1701, B 71, H 2	LED	930	3000	35	0,6	on/off
312471.00X.76	L 1701, B 71, H 2	LED	930	3000	35	0,6	DALI
312471.00X.1	L 1701, B 71, H 2	LED	940	3250	35	0,9	on/off
312471.00X.1.76	L 1701, B 71, H 2	LED	940	3250	35	0,9	DALI
312474.00X	L 1701, B 71, H 2	LED	930	5350	72	2,6	on/off
312474.00X.76	L 1701, B 71, H 2	LED	930	5350	72	2,6	DALI
312474.00X.1	L 1701, B 71, H 2	LED	940	5800	72	2,9	on/off
312474.00X.1.76	L 1701, B 71, H 2	LED	940	5800	72	2,9	DALI
<b>Haz medio 30°</b>							
312472.00X	L 1701, B 71, H 2	LED	930	2900	35	1,4	on/off
312472.00X.76	L 1701, B 71, H 2	LED	930	2900	35	1,4	DALI
312472.00X.1	L 1701, B 71, H 2	LED	940	3150	35	1,7	on/off
312472.00X.1.76	L 1701, B 71, H 2	LED	940	3150	35	1,7	DALI
312475.00X	L 1701, B 71, H 2	LED	930	5200	72	3,4	on/off
312475.00X.76	L 1701, B 71, H 2	LED	930	5200	72	3,4	DALI
312475.00X.1	L 1701, B 71, H 2	LED	940	5600	72	3,7	on/off
312475.00X.1.76	L 1701, B 71, H 2	LED	940	5600	72	3,7	DALI
<b>Haz extensivo 50°</b>							
312473.00X	L 1701, B 71, H 2	LED	930	3050	35	3,5	on/off
312473.00X.76	L 1701, B 71, H 2	LED	930	3050	35	3,5	DALI
312473.00X.1	L 1701, B 71, H 2	LED	940	3300	35	3,8	on/off
312473.00X.1.76	L 1701, B 71, H 2	LED	940	3300	35	3,8	DALI
312476.00X	L 1701, B 71, H 2	LED	930	5400	72	5,5	on/off
312476.00X.76	L 1701, B 71, H 2	LED	930	5400	72	5,5	DALI
312476.00X.1	L 1701, B 71, H 2	LED	940	5850	72	5,7	on/off
312476.00X.1.76	L 1701, B 71, H 2	LED	940	5850	72	5,7	DALI

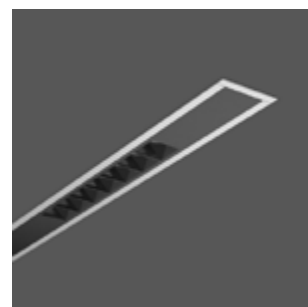

### Luminaria con 4 módulos LED



Nº artículo	Dimensiones [mm]	Fuente de luz	Color de la luz	Flujo luminoso de la luminaria [lm]	Potencia luminaria [W]	UGR	Regulación
<b>Luminarias empotrables en techo y pared</b>							
<b>Luminaria con 4 módulos LED - LA 2243 x BA 60 mm, HE 125 mm</b>							
<b>Haz intensivo 10°</b>							
312477.00X	L 2256, B 71, H 2	LED	930	4050	47	0,6	on/off
312477.00X.76	L 2256, B 71, H 2	LED	930	4050	47	0,6	DALI
312477.00X.1	L 2256, B 71, H 2	LED	940	4350	47	0,9	on/off
312477.00X.1.76	L 2256, B 71, H 2	LED	940	4350	47	0,9	DALI
312480.00X	L 2256, B 71, H 2	LED	930	7200	97	2,6	on/off
312480.00X.76	L 2256, B 71, H 2	LED	930	7200	97	2,6	DALI
312480.00X.1	L 2256, B 71, H 2	LED	940	7800	97	2,9	on/off
312480.00X.1.76	L 2256, B 71, H 2	LED	940	7800	97	2,9	DALI
<b>Haz medio 30°</b>							
312478.00X	L 2256, B 71, H 2	LED	930	3950	47	1,5	on/off
312478.00X.76	L 2256, B 71, H 2	LED	930	3950	47	1,5	DALI
312478.00X.1	L 2256, B 71, H 2	LED	940	4200	47	1,7	on/off
312478.00X.1.76	L 2256, B 71, H 2	LED	940	4200	47	1,7	DALI
312481.00X	L 2256, B 71, H 2	LED	930	6950	97	3,4	on/off
312481.00X.76	L 2256, B 71, H 2	LED	930	6950	97	3,4	DALI
312481.00X.1	L 2256, B 71, H 2	LED	940	7550	97	3,7	on/off
312481.00X.1.76	L 2256, B 71, H 2	LED	940	7550	97	3,7	DALI
<b>Haz extensivo 50°</b>							
312479.00X	L 2256, B 71, H 2	LED	930	4100	47	3,5	on/off
312479.00X.76	L 2256, B 71, H 2	LED	930	4100	47	3,5	DALI
312479.00X.1	L 2256, B 71, H 2	LED	940	4400	47	3,8	on/off
312479.00X.1.76	L 2256, B 71, H 2	LED	940	4400	47	3,8	DALI
312482.00X	L 2256, B 71, H 2	LED	930	7250	97	5,5	on/off
312482.00X.76	L 2256, B 71, H 2	LED	930	7250	97	5,5	DALI
312482.00X.1	L 2256, B 71, H 2	LED	940	7900	97	5,8	on/off
312482.00X.1.76	L 2256, B 71, H 2	LED	940	7900	97	5,8	DALI

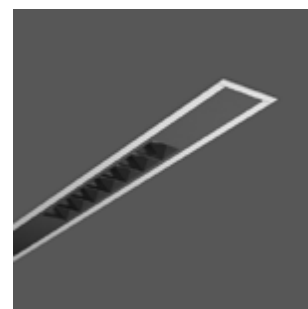

# LESS IS MORE® BEAMLINE

## Descripción del producto | Luminarias de techo

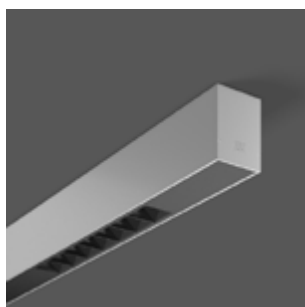

### Luminarias de techo | Less is more BeamLine

Tipo de Protección: IP 20  
Clase de Protección: I  
Protección contra golpes: IK03

Carcasa de perfil de aluminio extruido, revestido al polvo. Tapas finales de aluminio revestido al polvo. Módulo LED con **tecnología MRS**: sistema de mini reflectores hechos de termoplástico metalizado con marco antideslumbrante prismático negro, para una iluminación agradable sin deslumbramiento (UGR < 10). Cada módulo LED se compone de 7 mini reflectores. Disponible en tres haces de luz (intensivo, medio o extensivo) que permite un uso flexible. Módulo LED sustituible y extraíble con equipo integrado.

Colores disponibles (X): 2 = blanco, 3 = negro, 45 = blanco aluminio

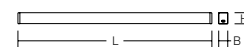

### Luminaria con 2 módulos LED

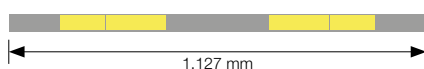

Nº artículo	Dimensiones [mm]	Fuente de luz	Color de la luz	Flujo luminoso de la luminaria [lm]	Potencia luminaria [W]	UGR	Regulación
<b>Luminarias de techo</b>							
<b>Categoría de Precios 21</b>							
<b>Luminaria con 2 módulos LED</b>							
<b>Haz intensivo 10°</b>							
	312483.00X	L 1127, B 57, H 75	LED	930	2050	23	0,7 on/off
	312483.00X.76	L 1127, B 57, H 75	LED	930	2050	23	0,7 DALI
	312483.00X.1	L 1127, B 57, H 75	LED	940	2200	23	0,9 on/off
	312483.00X.1.76	L 1127, B 57, H 75	LED	940	2200	23	0,9 DALI
<hr/>							
	312486.00X	L 1127, B 57, H 75	LED	930	3600	48	2,6 on/off
	312486.00X.76	L 1127, B 57, H 75	LED	930	3600	48	2,6 DALI
	312486.00X.1	L 1127, B 57, H 75	LED	940	3900	48	2,9 on/off
	312486.00X.1.76	L 1127, B 57, H 75	LED	940	3900	48	2,9 DALI
<hr/>							
<b>Haz medio 30°</b>							
	312484.00X	L 1127, B 57, H 75	LED	930	1950	23	1,4 on/off
	312484.00X.76	L 1127, B 57, H 75	LED	930	1950	23	1,4 DALI
	312484.00X.1	L 1127, B 57, H 75	LED	940	2100	23	1,7 on/off
	312484.00X.1.76	L 1127, B 57, H 75	LED	940	2100	23	1,7 DALI
<hr/>							
	312487.00X	L 1127, B 57, H 75	LED	930	3500	48	3,4 on/off
	312487.00X.76	L 1127, B 57, H 75	LED	930	3500	48	3,4 DALI
	312487.00X.1	L 1127, B 57, H 75	LED	940	3800	48	3,7 on/off
	312487.00X.1.76	L 1127, B 57, H 75	LED	940	3800	48	3,7 DALI
<hr/>							
<b>Haz extensivo 50°</b>							
	312485.00X	L 1127, B 57, H 75	LED	930	2050	23	3,5 on/off
	312485.00X.76	L 1127, B 57, H 75	LED	930	2050	23	3,5 DALI
	312485.00X.1	L 1127, B 57, H 75	LED	940	2200	23	3,8 on/off
	312485.00X.1.76	L 1127, B 57, H 75	LED	940	2200	23	3,8 DALI
<hr/>							
	312488.00X	L 1127, B 57, H 75	LED	930	3650	48	5,5 on/off
	312488.00X.76	L 1127, B 57, H 75	LED	930	3650	48	5,5 DALI
	312488.00X.1	L 1127, B 57, H 75	LED	940	3950	48	5,8 on/off
	312488.00X.1.76	L 1127, B 57, H 75	LED	940	3950	48	5,8 DALI

### Luminaria con 3 módulos LED

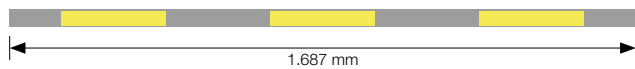

Nº artículo	Dimensiones [mm]	Fuente de luz	Color de la luz	Flujo luminoso de la luminaria [lm]	Potencia luminaria [W]	UGR	Regulación
<b>Luminarias de techo</b>							
<b>Luminaria con 3 módulos LED</b>							
<b>Haz intensivo 10°</b>							
312489.00X	L 1687, B 57, H 75	LED	930	3000	35	0,6	on/off
312489.00X.76	L 1687, B 57, H 75	LED	930	3000	35	0,6	DALI
312489.00X.1	L 1687, B 57, H 75	LED	940	3250	35	0,9	on/off
312489.00X.1.76	L 1687, B 57, H 75	LED	940	3250	35	0,9	DALI
312492.00X	L 1687, B 57, H 75	LED	930	5350	72	2,6	on/off
312492.00X.76	L 1687, B 57, H 75	LED	930	5350	72	2,6	DALI
312492.00X.1	L 1687, B 57, H 75	LED	940	5800	72	2,9	on/off
312492.00X.1.76	L 1687, B 57, H 75	LED	940	5800	72	2,9	DALI
<b>Haz medio 30°</b>							
312490.00X	L 1687, B 57, H 75	LED	930	2900	35	1,4	on/off
312490.00X.76	L 1687, B 57, H 75	LED	930	2900	35	1,4	DALI
312490.00X.1	L 1687, B 57, H 75	LED	940	3150	35	1,7	on/off
312490.00X.1.76	L 1687, B 57, H 75	LED	940	3150	35	1,7	DALI
312493.00X	L 1687, B 57, H 75	LED	930	5200	72	3,4	on/off
312493.00X.76	L 1687, B 57, H 75	LED	930	5200	72	3,4	DALI
312493.00X.1	L 1687, B 57, H 75	LED	940	5600	72	3,7	on/off
312493.00X.1.76	L 1687, B 57, H 75	LED	940	5600	72	3,7	DALI
<b>Haz extensivo 50°</b>							
312491.00X	L 1687, B 57, H 75	LED	930	3050	35	3,5	on/off
312491.00X.76	L 1687, B 57, H 75	LED	930	3050	35	3,5	DALI
312491.00X.1	L 1687, B 57, H 75	LED	940	3300	35	3,8	on/off
312491.00X.1.76	L 1687, B 57, H 75	LED	940	3300	35	3,8	DALI
312494.00X	L 1687, B 57, H 75	LED	930	5400	72	5,5	on/off
312494.00X.76	L 1687, B 57, H 75	LED	930	5400	72	5,5	DALI
312494.00X.1	L 1687, B 57, H 75	LED	940	5850	72	5,7	on/off
312494.00X.1.76	L 1687, B 57, H 75	LED	940	5850	72	5,7	DALI

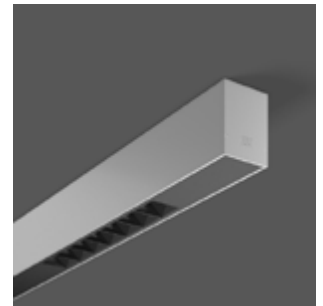

### Luminaria con 4 módulos LED

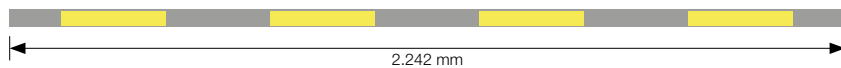

Nº artículo	Dimensiones [mm]	Fuente de luz	Color de la luz	Flujo luminoso de la luminaria [lm]	Potencia luminaria [W]	UGR	Regulación
<b>Luminarias de techo</b>							
<b>Luminaria con 4 módulos LED</b>							
<b>Haz intensivo 10°</b>							
312495.00X	L 2242, B 57, H 75	LED	930	4050	47	0,6	on/off
312495.00X.76	L 2242, B 57, H 75	LED	930	4050	47	0,6	DALI
312495.00X.1	L 2242, B 57, H 75	LED	940	4350	47	0,9	on/off
312495.00X.1.76	L 2242, B 57, H 75	LED	940	4350	47	0,9	DALI
312498.00X	L 2242, B 57, H 75	LED	930	7200	97	2,6	on/off
312498.00X.76	L 2242, B 57, H 75	LED	930	7200	97	2,6	DALI
312498.00X.1	L 2242, B 57, H 75	LED	940	7800	97	2,9	on/off
312498.00X.1.76	L 2242, B 57, H 75	LED	940	7800	97	2,9	DALI
<b>Haz medio 30°</b>							
312496.00X	L 2242, B 57, H 75	LED	930	3950	47	1,5	on/off
312496.00X.76	L 2242, B 57, H 75	LED	930	3950	47	1,5	DALI
312496.00X.1	L 2242, B 57, H 75	LED	940	4200	47	1,7	on/off
312496.00X.1.76	L 2242, B 57, H 75	LED	940	4200	47	1,7	DALI
312499.00X	L 2242, B 57, H 75	LED	930	6950	97	3,4	on/off
312499.00X.76	L 2242, B 57, H 75	LED	930	6950	97	3,4	DALI
312499.00X.1	L 2242, B 57, H 75	LED	940	7550	97	3,7	on/off
312499.00X.1.76	L 2242, B 57, H 75	LED	940	7550	97	3,7	DALI
<b>Haz extensivo 50°</b>							
312497.00X	L 2242, B 57, H 75	LED	930	4100	47	3,5	on/off
312497.00X.76	L 2242, B 57, H 75	LED	930	4100	47	3,5	DALI
312497.00X.1	L 2242, B 57, H 75	LED	940	4400	47	3,8	on/off
312497.00X.1.76	L 2242, B 57, H 75	LED	940	4400	47	3,8	DALI
312500.00X	L 2242, B 57, H 75	LED	930	7250	97	5,5	on/off
312500.00X.76	L 2242, B 57, H 75	LED	930	7250	97	5,5	DALI
312500.00X.1	L 2242, B 57, H 75	LED	940	7900	97	5,8	on/off
312500.00X.1.76	L 2242, B 57, H 75	LED	940	7900	97	5,8	DALI

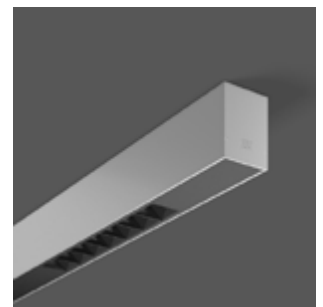

# LESS IS MORE® BEAMLINE

Descripción del producto | Luminarias de suspensión directa



## Luminarias para montaje en suspensión | Less is more BeamLine

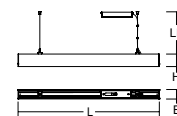

Tipo de Protección: IP 20  
Clase de Protección: I  
Longitud de Suspensión: 2000 mm

Carcasa de perfil de aluminio extruido, revestido al polvo. Tapas finales de aluminio revestido al polvo. Módulo LED con **tecnología MRS**: sistema de mini reflectores hechos de termoplástico metalizado con marco antideslumbrante prismático negro, para una iluminación agradable sin deslumbramiento (UGR < 10). Cada módulo LED se compone de 7 mini reflectores. Iluminación directa. Disponible en tres haces de luz (intensivo, medio o extensivo) que permite un uso flexible. Módulo LED sustituible y extraíble con equipo integrado. Cable de suspensión de acero, fijación en 2 puntos, posicionamiento variable y regulación continua de la distancia. A petición, longitudes especiales indicadas por el cliente. Colores disponibles (X): 2 = blanco, 3 = negro, 45 = blanco aluminio

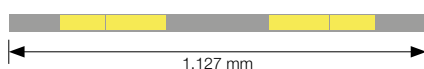

### Luminaria con 2 módulos LED



Nº artículo	Dimensiones [mm]	Fuente de luz	Color de la luz	Flujo luminoso de la luminaria [lm]	Potencia luminaria [W]	UGR	Regulación
<b>Luminarias para montaje en suspensión - Iluminación directa</b>							
<b>Categoría de Precios 21</b>							
<b>Luminaria con 2 módulos LED</b>							
<b>Haz intensivo 10°</b>							
	312501.00X	L 1127, B 57, H 75	LED	930	2050	23	0,7 on/off
	312501.00X.76	L 1127, B 57, H 75	LED	930	2050	23	0,7 DALI
	312501.00X.1	L 1127, B 57, H 75	LED	940	2200	23	0,9 on/off
	312501.00X.1.76	L 1127, B 57, H 75	LED	940	2200	23	0,9 DALI
<hr/>							
	312504.00X	L 1127, B 57, H 75	LED	930	3600	48	2,6 on/off
	312504.00X.76	L 1127, B 57, H 75	LED	930	3600	48	2,6 DALI
	312504.00X.1	L 1127, B 57, H 75	LED	940	3900	48	2,9 on/off
	312504.00X.1.76	L 1127, B 57, H 75	LED	940	3900	48	2,9 DALI
<hr/>							
<b>Haz medio 30°</b>							
	312502.00X	L 1127, B 57, H 75	LED	930	1950	23	1,4 on/off
	312502.00X.76	L 1127, B 57, H 75	LED	930	1950	23	1,4 DALI
	312502.00X.1	L 1127, B 57, H 75	LED	940	2100	23	1,7 on/off
	312502.00X.1.76	L 1127, B 57, H 75	LED	940	2100	23	1,7 DALI
<hr/>							
	312505.00X	L 1127, B 57, H 75	LED	930	3500	48	3,4 on/off
	312505.00X.76	L 1127, B 57, H 75	LED	930	3500	48	3,4 DALI
	312505.00X.1	L 1127, B 57, H 75	LED	940	3800	48	3,7 on/off
	312505.00X.1.76	L 1127, B 57, H 75	LED	940	3800	48	3,7 DALI
<hr/>							
<b>Haz extensivo 50°</b>							
	312503.00X	L 1127, B 57, H 75	LED	930	2050	23	3,5 on/off
	312503.00X.76	L 1127, B 57, H 75	LED	930	2050	23	3,5 DALI
	312503.00X.1	L 1127, B 57, H 75	LED	940	2200	23	3,8 on/off
	312503.00X.1.76	L 1127, B 57, H 75	LED	940	2200	23	3,8 DALI
<hr/>							
	312506.00X	L 1127, B 57, H 75	LED	930	3650	48	5,5 on/off
	312506.00X.76	L 1127, B 57, H 75	LED	930	3650	48	5,5 DALI
	312506.00X.1	L 1127, B 57, H 75	LED	940	3950	48	5,8 on/off
	312506.00X.1.76	L 1127, B 57, H 75	LED	940	3950	48	5,8 DALI

## Luminaria con 3 módulos LED

## Descripción del producto | Luminarias de suspensión directa

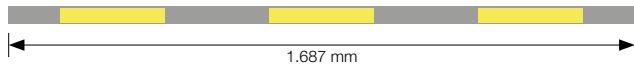

Nº artículo	Dimensiones [mm]	Fuente de luz	Color de la luz	Flujo luminoso de la luminaria [lm]	Potencia luminaria [W]	UGR	Regulación
<b>Luminarias para montaje en suspensión - Iluminación directa</b>							
<b>Luminaria con 3 módulos LED</b>							
<b>Haz intensivo 10°</b>							
312513.00X	L 1687, B 57, H 75	LED	930	3000	35	0,6	on/off
312513.00X.76	L 1687, B 57, H 75	LED	930	3000	35	0,6	DALI
312513.00X.1	L 1687, B 57, H 75	LED	940	3250	35	0,9	on/off
312513.00X.1.76	L 1687, B 57, H 75	LED	940	3250	35	0,9	DALI
312516.00X	L 1687, B 57, H 75	LED	930	5350	72	2,6	on/off
312516.00X.76	L 1687, B 57, H 75	LED	930	5350	72	2,6	DALI
312516.00X.1	L 1687, B 57, H 75	LED	940	5800	72	2,9	on/off
312516.00X.1.76	L 1687, B 57, H 75	LED	940	5800	72	2,9	DALI
<b>Haz medio 30°</b>							
312514.00X	L 1687, B 57, H 75	LED	930	2900	35	1,4	on/off
312514.00X.76	L 1687, B 57, H 75	LED	930	2900	35	1,4	DALI
312514.00X.1	L 1687, B 57, H 75	LED	940	3150	35	1,7	on/off
312514.00X.1.76	L 1687, B 57, H 75	LED	940	3150	35	1,7	DALI
312517.00X	L 1687, B 57, H 75	LED	930	5200	72	3,4	on/off
312517.00X.76	L 1687, B 57, H 75	LED	930	5200	72	3,4	DALI
312517.00X.1	L 1687, B 57, H 75	LED	940	5600	72	3,7	on/off
312517.00X.1.76	L 1687, B 57, H 75	LED	940	5600	72	3,7	DALI
<b>Haz extensivo 50°</b>							
312515.00X	L 1687, B 57, H 75	LED	930	3050	35	3,5	on/off
312515.00X.76	L 1687, B 57, H 75	LED	930	3050	35	3,5	DALI
312515.00X.1	L 1687, B 57, H 75	LED	940	3300	35	3,8	on/off
312515.00X.1.76	L 1687, B 57, H 75	LED	940	3300	35	3,8	DALI
312518.00X	L 1687, B 57, H 75	LED	930	5400	72	5,5	on/off
312518.00X.76	L 1687, B 57, H 75	LED	930	5400	72	5,5	DALI
312518.00X.1	L 1687, B 57, H 75	LED	940	5850	72	5,7	on/off
312518.00X.1.76	L 1687, B 57, H 75	LED	940	5850	72	5,7	DALI

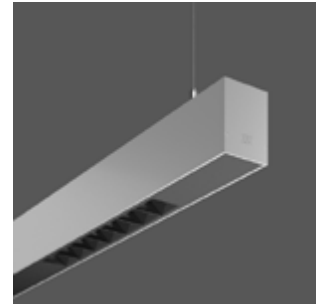

## Luminaria con 4 módulos LED

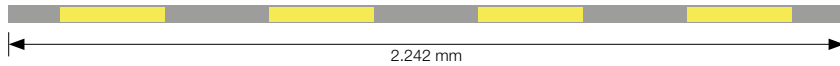

Nº artículo	Dimensiones [mm]	Fuente de luz	Color de la luz	Flujo luminoso de la luminaria [lm]	Potencia luminaria [W]	UGR	Regulación
<b>Luminarias para montaje en suspensión - Iluminación directa</b>							
<b>Luminaria con 4 módulos LED</b>							
<b>Haz intensivo 10°</b>							
312525.00X	L 2242, B 57, H 75	LED	930	4050	47	0,6	on/off
312525.00X.76	L 2242, B 57, H 75	LED	930	4050	47	0,6	DALI
312525.00X.1	L 2242, B 57, H 75	LED	940	4350	47	0,9	on/off
312525.00X.1.76	L 2242, B 57, H 75	LED	940	4350	47	0,9	DALI
312528.00X	L 2242, B 57, H 75	LED	930	7200	97	2,6	on/off
312528.00X.76	L 2242, B 57, H 75	LED	930	7200	97	2,6	DALI
312528.00X.1	L 2242, B 57, H 75	LED	940	7800	97	2,9	on/off
312528.00X.1.76	L 2242, B 57, H 75	LED	940	7800	97	2,9	DALI
<b>Haz medio 30°</b>							
312526.00X	L 2242, B 57, H 75	LED	930	3950	47	1,5	on/off
312526.00X.76	L 2242, B 57, H 75	LED	930	3950	47	1,5	DALI
312526.00X.1	L 2242, B 57, H 75	LED	940	4200	47	1,7	on/off
312526.00X.1.76	L 2242, B 57, H 75	LED	940	4200	47	1,7	DALI
312529.00X	L 2242, B 57, H 75	LED	930	6950	97	3,4	on/off
312529.00X.76	L 2242, B 57, H 75	LED	930	6950	97	3,4	DALI
312529.00X.1	L 2242, B 57, H 75	LED	940	7550	97	3,7	on/off
312529.00X.1.76	L 2242, B 57, H 75	LED	940	7550	97	3,7	DALI
<b>Haz extensivo 50°</b>							
312527.00X	L 2242, B 57, H 75	LED	930	4100	47	3,5	on/off
312527.00X.76	L 2242, B 57, H 75	LED	930	4100	47	3,5	DALI
312527.00X.1	L 2242, B 57, H 75	LED	940	4400	47	3,8	on/off
312527.00X.1.76	L 2242, B 57, H 75	LED	940	4400	47	3,8	DALI
312530.00X	L 2242, B 57, H 75	LED	930	7250	97	5,5	on/off
312530.00X.76	L 2242, B 57, H 75	LED	930	7250	97	5,5	DALI
312530.00X.1	L 2242, B 57, H 75	LED	940	7900	97	5,8	on/off
312530.00X.1.76	L 2242, B 57, H 75	LED	940	7900	97	5,8	DALI



# LESS IS MORE® BEAMLINE

Descripción del producto | Luminarias de suspensión directa/indirecta



## Luminarias para montaje en suspensión | Less is more BeamLine

Tipo de Protección: IP 20  
Clase de Protección: I  
Longitud de Suspensión: 2000 mm

Carcasa de perfil de aluminio extruido, revestido al polvo. Tapas finales de aluminio revestido al polvo. Módulo LED con **tecnología MRS**: sistema de mini reflectores hechos de termoplástico metalizado con marco antideslumbrante prismático negro, para una iluminación agradable sin deslumbramiento (UGR < 10). Cada módulo LED se compone de 7 mini reflectores. Iluminación directa/indirecta. Disponible en tres haces de luz (intensivo, medio o extensivo) que permite un uso flexible. Módulo LED sustituible y extraíble con equipo integrado. Cable de suspensión de acero, fijación en 2 puntos, posicionamiento variable y regulación continua de la distancia. A petición, longitudes especiales indicadas por el cliente.

Colores disponibles (X): 2 = blanco, 3 = negro, 45 = blanco aluminio

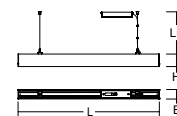

### Luminaria con 2 módulos LED

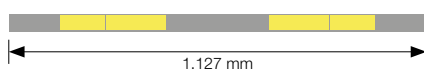

Nº artículo	Dimensiones [mm]	Fuente de luz	Color de la luz	Flujo luminoso de la luminaria [lm]	Potencia luminaria [W]	UGR	Regulación
<b>Luminarias para montaje en suspensión - Iluminación directa/indirecta</b>							
<b>Categoría de Precios 21</b>							
<b>Luminaria con 2 módulos LED</b>							
<b>Haz intensivo 10° - Iluminación directa 55%, indirecta 45%</b>							
	312507.00X	L 1127, B 57, H 75	LED	930	3650	38	0,7 on/off
	312507.00X.76	L 1127, B 57, H 75	LED	930	3650	38	0,7 DALI
	312507.00X.1	L 1127, B 57, H 75	LED	940	3850	38	0,9 on/off
	312507.00X.1.76	L 1127, B 57, H 75	LED	940	3850	38	0,9 DALI
<b>Haz intensivo 10° - Iluminación directa 67%, indirecta 33%</b>							
	312510.00X	L 1127, B 57, H 75	LED	930	5200	63	3,6 on/off
	312510.00X.76	L 1127, B 57, H 75	LED	930	5200	63	3,6 DALI
	312510.00X.1	L 1127, B 57, H 75	LED	940	5600	63	3,8 on/off
	312510.00X.1.76	L 1127, B 57, H 75	LED	940	5600	63	3,8 DALI
<b>Haz medio 30° - Iluminación directa 55%, indirecta 45%</b>							
	312508.00X	L 1127, B 57, H 75	LED	930	3600	38	1,1 on/off
	312508.00X.76	L 1127, B 57, H 75	LED	930	3600	38	1,1 DALI
	312508.00X.1	L 1127, B 57, H 75	LED	940	3800	38	1,3 on/off
	312508.00X.1.76	L 1127, B 57, H 75	LED	940	3800	38	1,3 DALI
<b>Haz medio 30° - Iluminación directa 67%, indirecta 33%</b>							
	312511.00X	L 1127, B 57, H 75	LED	930	5100	63	4,3 on/off
	312511.00X.76	L 1127, B 57, H 75	LED	930	5100	63	4,3 DALI
	312511.00X.1	L 1127, B 57, H 75	LED	940	5450	63	4,5 on/off
	312511.00X.1.76	L 1127, B 57, H 75	LED	940	5450	63	4,5 DALI
<b>Haz extensivo 50° - Iluminación directa 55%, indirecta 45%</b>							
	312509.00X	L 1127, B 57, H 75	LED	930	3650	38	3,7 on/off
	312509.00X.76	L 1127, B 57, H 75	LED	930	3650	38	3,7 DALI
	312509.00X.1	L 1127, B 57, H 75	LED	940	3900	38	4,0 on/off
	312509.00X.1.76	L 1127, B 57, H 75	LED	940	3900	38	4,0 DALI
<b>Haz extensivo 50° - Iluminación directa 67%, indirecta 33%</b>							
	312512.00X	L 1127, B 57, H 75	LED	930	5250	63	6,9 on/off
	312512.00X.76	L 1127, B 57, H 75	LED	930	5250	63	6,9 DALI
	312512.00X.1	L 1127, B 57, H 75	LED	940	5600	63	7,1 on/off
	312512.00X.1.76	L 1127, B 57, H 75	LED	940	5600	63	7,1 DALI



## Luminaria con 3 módulos LED

## Descripción del producto | Luminarias de suspensión directa/indirecta

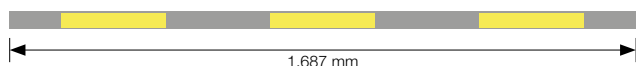

Nº artículo	Dimensiones [mm]	Fuente de luz	Color de la luz	Flujo luminoso de la luminaria [lm]	Potencia luminaria [W]	UGR	Regulación
<b>Luminarias para montaje en suspensión - Iluminación directa/indirecta</b>							
<b>Luminaria con 3 módulos LED</b>							
<b>Haz intensivo 10° - Iluminación directa 55%, indirecta 45%</b>							
312519.00X	L 1687, B 57, H 75	LED	930	5450	55	2,6	on/off
312519.00X.76	L 1687, B 57, H 75	LED	930	5450	55	2,6	DALI
312519.00X.1	L 1687, B 57, H 75	LED	940	5800	55	2,8	on/off
312519.00X.1.76	L 1687, B 57, H 75	LED	940	5800	55	2,8	DALI
<b>Haz intensivo 10° - Iluminación directa 67%, indirecta 33%</b>							
312522.00X	L 1687, B 57, H 75	LED	930	7700	93	3,8	on/off
312522.00X.76	L 1687, B 57, H 75	LED	930	7700	93	3,8	DALI
312522.00X.1	L 1687, B 57, H 75	LED	940	8250	93	4,0	on/off
312522.00X.1.76	L 1687, B 57, H 75	LED	940	8250	93	4,0	DALI
<b>Haz medio 30° - Iluminación directa 55%, indirecta 45%</b>							
312520.00X	L 1687, B 57, H 75	LED	930	5300	55	3,0	on/off
312520.00X.76	L 1687, B 57, H 75	LED	930	5300	55	3,0	DALI
312520.00X.1	L 1687, B 57, H 75	LED	940	5650	55	3,2	on/off
312520.00X.1.76	L 1687, B 57, H 75	LED	940	5650	55	3,2	DALI
<b>Haz medio 30° - Iluminación directa 67%, indirecta 33%</b>							
312523.00X	L 1687, B 57, H 75	LED	930	7500	93	4,2	on/off
312523.00X.76	L 1687, B 57, H 75	LED	930	7500	93	4,2	DALI
312523.00X.1	L 1687, B 57, H 75	LED	940	8050	93	4,4	on/off
312523.00X.1.76	L 1687, B 57, H 75	LED	940	8050	93	4,4	DALI
<b>Haz extensivo 50° - Iluminación directa 55%, indirecta 45%</b>							
312521.00X	L 1687, B 57, H 75	LED	930	5450	55	4,4	on/off
312521.00X.76	L 1687, B 57, H 75	LED	930	5450	55	4,4	DALI
312521.00X.1	L 1687, B 57, H 75	LED	940	5850	55	4,6	on/off
312521.00X.1.76	L 1687, B 57, H 75	LED	940	5850	55	4,6	DALI
<b>Haz extensivo 50° - Iluminación directa 67%, indirecta 33%</b>							
312524.00X	L 1687, B 57, H 75	LED	930	7750	93	5,6	on/off
312524.00X.76	L 1687, B 57, H 75	LED	930	7750	93	5,6	DALI
312524.00X.1	L 1687, B 57, H 75	LED	940	8300	93	5,8	on/off
312524.00X.1.76	L 1687, B 57, H 75	LED	940	8300	93	5,8	DALI



## Luminaria con 4 módulos LED



Nº artículo	Dimensiones [mm]	Fuente de luz	Color de la luz	Flujo luminoso de la luminaria [lm]	Potencia luminaria [W]	UGR	Regulación
<b>Luminarias para montaje en suspensión - Iluminación directa/indirecta</b>							
<b>Luminaria con 4 módulos LED</b>							
<b>Haz intensivo 10° - Iluminación directa 55%, indirecta 45%</b>							
312531.00X	L 2242, B 57, H 75	LED	930	7300	76	0,7	on/off
312531.00X.76	L 2242, B 57, H 75	LED	930	7300	76	0,7	DALI
312531.00X.1	L 2242, B 57, H 75	LED	940	7700	76	0,9	on/off
312531.00X.1.76	L 2242, B 57, H 75	LED	940	7700	76	0,9	DALI
<b>Haz intensivo 10° - Iluminación directa 67%, indirecta 33%</b>							
312534.00X	L 2242, B 57, H 75	LED	930	10400	126	2,0	on/off
312534.00X.76	L 2242, B 57, H 75	LED	930	10400	126	2,0	DALI
312534.00X.1	L 2242, B 57, H 75	LED	940	11200	126	2,2	on/off
312534.00X.1.76	L 2242, B 57, H 75	LED	940	11200	126	2,2	DALI
<b>Haz medio 30° - Iluminación directa 55%, indirecta 45%</b>							
312532.00X	L 2242, B 57, H 75	LED	930	7150	76	1,1	on/off
312532.00X.76	L 2242, B 57, H 75	LED	930	7150	76	1,1	DALI
312532.00X.1	L 2242, B 57, H 75	LED	940	7550	76	1,3	on/off
312532.00X.1.76	L 2242, B 57, H 75	LED	940	7550	76	1,3	DALI
<b>Haz medio 30° - Iluminación directa 67%, indirecta 33%</b>							
312535.00X	L 2242, B 57, H 75	LED	930	10200	126	2,4	on/off
312535.00X.76	L 2242, B 57, H 75	LED	930	10200	126	2,4	DALI
312535.00X.1	L 2242, B 57, H 75	LED	940	10900	126	2,6	on/off
312535.00X.1.76	L 2242, B 57, H 75	LED	940	10900	126	2,6	DALI
<b>Haz extensivo 50° - Iluminación directa 55%, indirecta 45%</b>							
312533.00X	L 2242, B 57, H 75	LED	930	7350	76	3,8	on/off
312533.00X.76	L 2242, B 57, H 75	LED	930	7350	76	3,8	DALI
312533.00X.1	L 2242, B 57, H 75	LED	940	7750	76	4,0	on/off
312533.00X.1.76	L 2242, B 57, H 75	LED	940	7750	76	4,0	DALI
<b>Haz extensivo 50° - Iluminación directa 67%, indirecta 33%</b>							
312536.00X	L 2242, B 57, H 75	LED	930	10400	126	5,0	on/off
312536.00X.76	L 2242, B 57, H 75	LED	930	10400	126	5,0	DALI
312536.00X.1	L 2242, B 57, H 75	LED	940	11200	126	5,2	on/off
312536.00X.1.76	L 2242, B 57, H 75	LED	940	11200	126	5,2	DALI





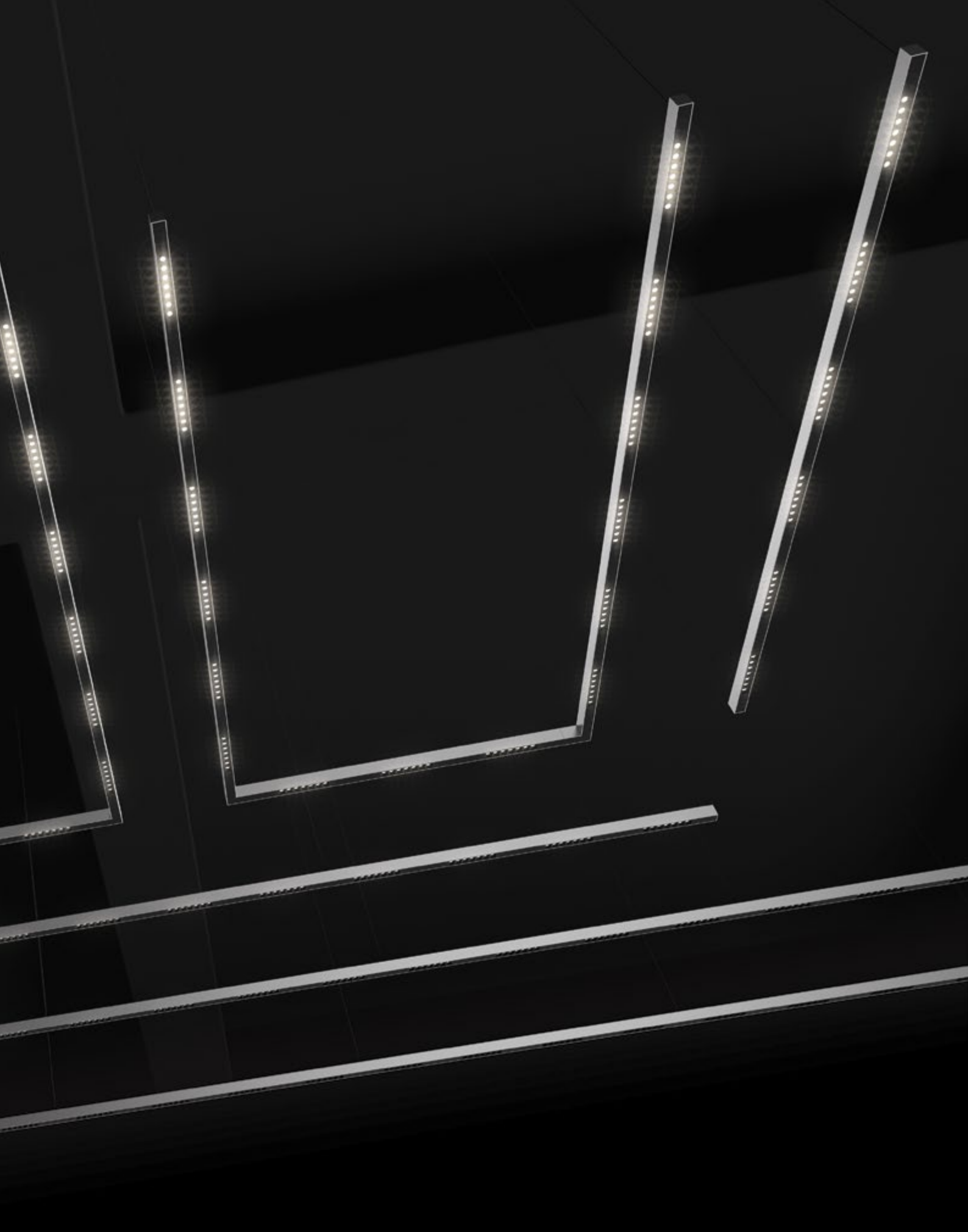

¡Juguemos! ¡Utilice el configurador LOUI en su planificación!

# LESS IS MORE® BEAMLINE - SYSTEM

Todo de un vistazo

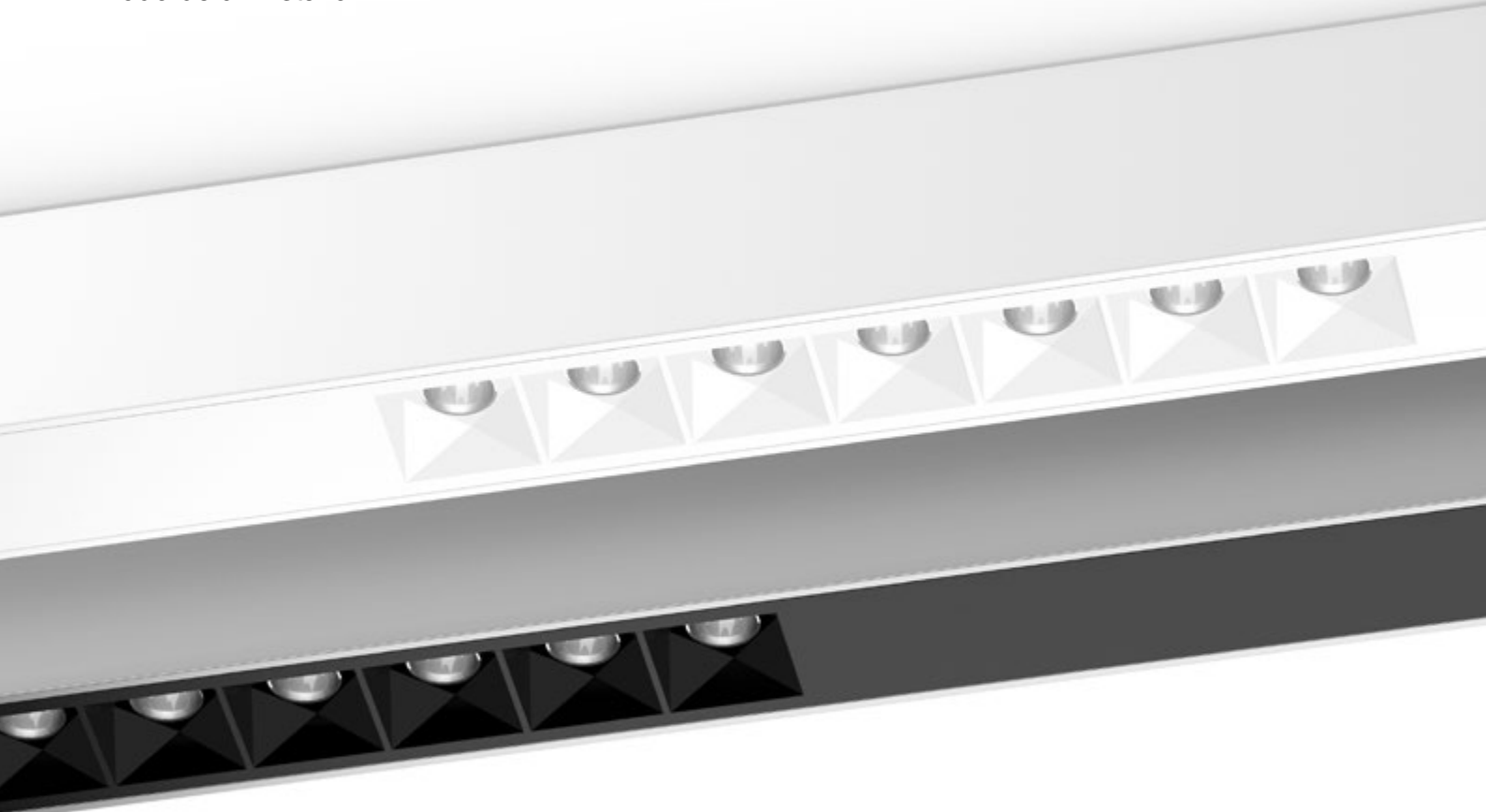

## La línea continua para una iluminación estéticamente sofisticada

- Hasta 50 m de línea continua
- Tecnología MRS para una iluminación agradable sin delumbramiento (UGR < 10)
- Disponible en tres haces de luz (intensivo, medio o extensivo) que permite un uso flexible
- Efecto darklight
- Módulo LED sustituible
- Cableado de paso interno
- Equipo incluido
- Flujo luminosos hasta 5000 lm/m
- Vida útil de LED: aprox. 50.000 h (L80, B10)
- Índice de reproducción cromática: Ra ≥ 90

empotrado

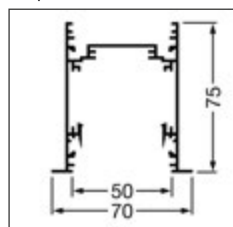

superficie | suspensión

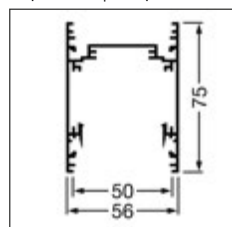

## Less is more BeamLine - Sistema

<b>Tipo de montaje</b>	
empotrado	✓
superficie	✓
suspensión	✓
<b>Iluminación</b>	
directa	✓
directa/indirecta	✓
<b>Color (Perfil/Óptica)</b>	
blanco/negro	✓
blanco aluminio/negro	✓
negro/negro	✓
blanco/blanco	✓
<b>Distribución de la luz</b>	
opalino	-
microprismático	-
Sistema óptico Alea (UGR ≤ 19)	-
Tecnología MRS (UGR < 10, intensivo, medio, extensivo)	✓
<b>Tipo de conmutación</b>	
on/off	✓
DALI	✓
<b>Colores de luz</b>	
930	✓
940	✓
<b>Equipo</b>	
externo	-
interno	✓
<b>Formas</b>	
„LOU!“	✓
„ΔZ“	-

### Tipos de montaje

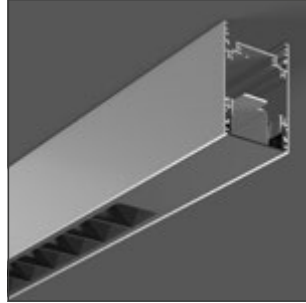
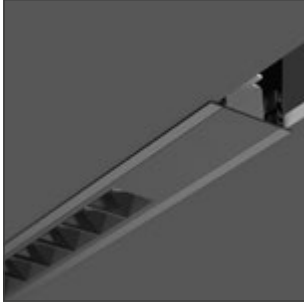

### empotrado | superficie | suspensión

Los tres tipos de montaje: en suspensión, en superficie o empotrado, proporcionan la libertad de diseño que el proyectista busca para sus proyectos.

### Módulos

#### 4 MÓDULOS COMBINABLES

1121 mm

1681 mm

2242 mm

143 x 143 mm

A través de los 4 módulos combinables se puede configurar cualquier longitud.

Esto permite obtener la longitud deseada en su proyecto.

### Tapa final

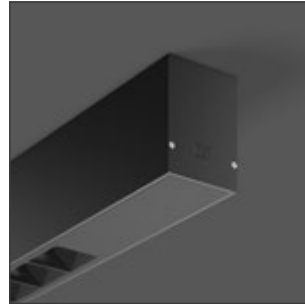

La tapa final a ras da al sistema un acabado liso y elegante.

### Unión

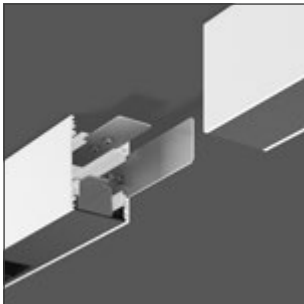

#### Unión mecánica y eléctrica sin fugas

La unión mecánica entre los perfiles proporciona estabilidad y seguridad. Este elemento de unión queda invisiblemente integrado en el perfil.

### Técnica de iluminación



#### Tecnología MRS

Sistema de mini reflectores hechos de termoplástico metalizado con marco antideslumbrante prismático negro, para una iluminación agradable sin deslumbramiento ( $UGR < 10$ ).

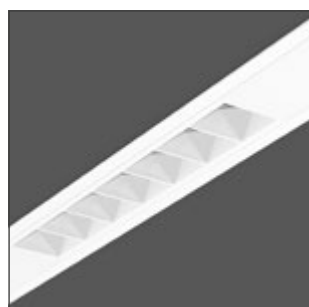

#### Tecnología MRS

Sistema de reflector en miniatura con marco antideslumbrante blanco.

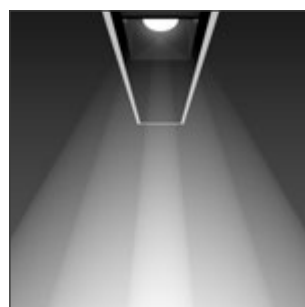

#### Haces de luz

Disponible en tres haces de luz (intensivo, medio o extensivo) que permite un uso flexible del marco.

# LESS IS MORE® BEAMLINE - SYSTEM

Luminarias empotradas, de superficie y suspension

Con Less is more BeamLine, los sistemas lineales se pueden diseñar de forma creativa e individual. Utilice el configurador LOUI para su planificación y no sólo podrá configurar exactamente la variante deseada, sino que también recibirá los documentos de planificación necesarios y el precio exacto.

¡Juguemos!

<http://www.rzb.de/es/productos/loui-configurador/>

Los conectores unen los perfiles de aluminio de forma estable, sin huecos, con precisión y firmeza

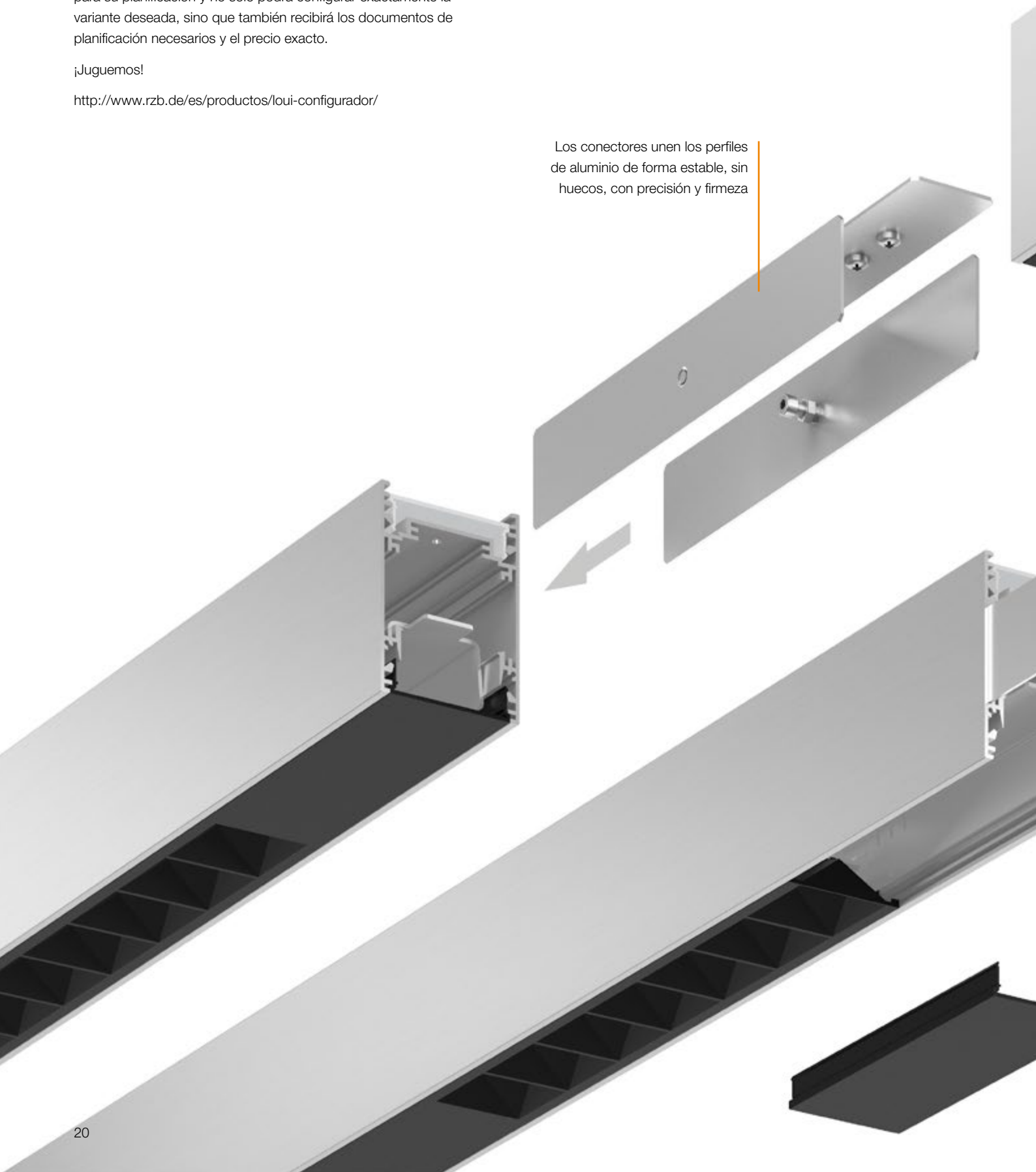

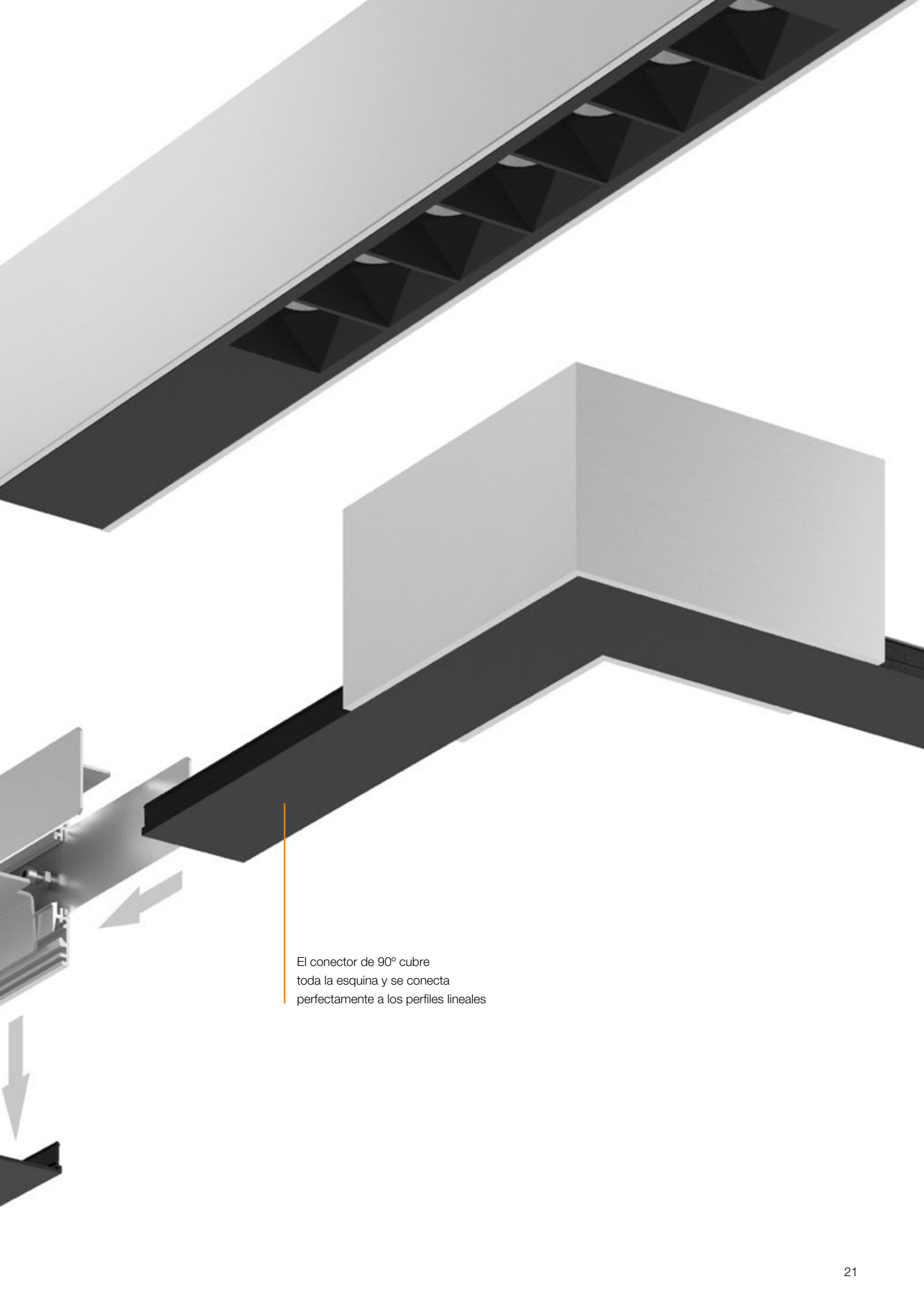

El conector de 90° cubre toda la esquina y se conecta perfectamente a los perfiles lineales

# LESS IS MORE® BEAMLINE - SYSTEM

## Configurador

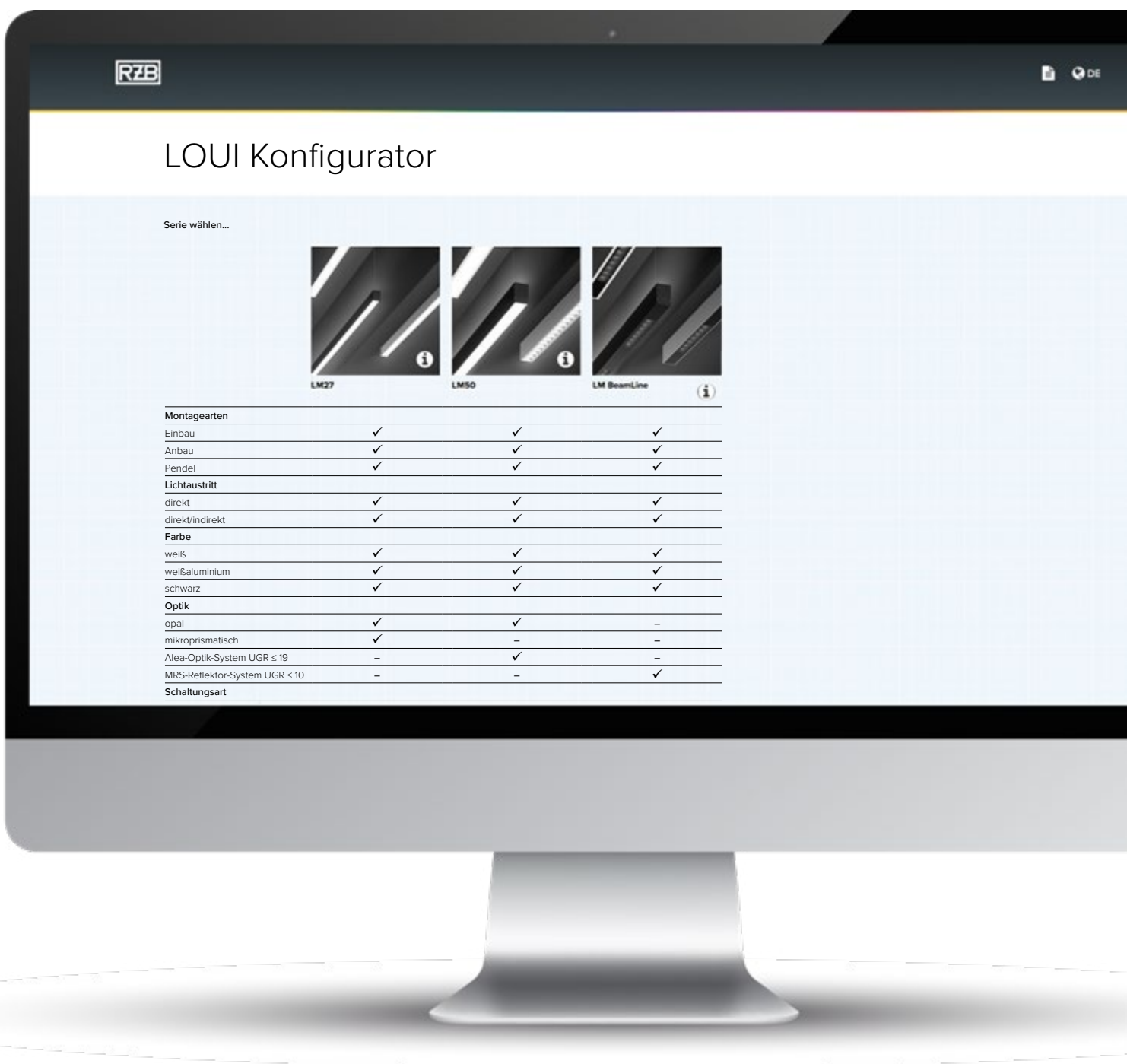



# Configurador LOUI

¡Nunca ha sido tan fácil planificar un proyecto!

Sus beneficios:

- ⊕ Configuración de su línea continua
- ⊕ Información directa sobre precios y desglose de componentes
- ⊕ Incluido plano de montaje de su sistema en formato DXF
- ⊕ Incluido el fichero ROLFZ de su diseño para su incorporación directa a RELUX!

5

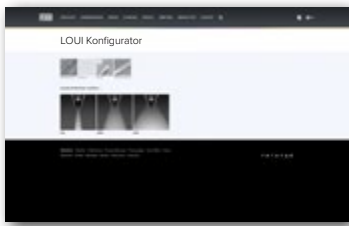

...Distribución de la luz...

6

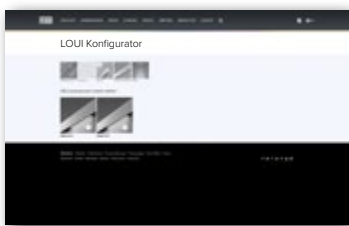

...potencia LED...

7

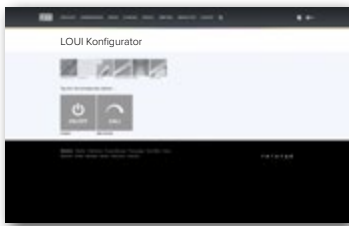

...tipo de conmutación...

8

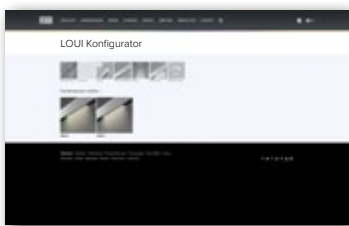

...y temperatura de color

9



Determine las dimensiones deseadas; sólo se sugieren las dimensiones factibles.

**Result**  
Art. no. 1K-LM1034-00000001

2.382,00 € net  
excl. 19% VAT (shipping costs may apply)  
**2.834,58 €**

Show price information for **Deutschland**

To view the DXF-file, you can use these online viewers:  
[Autodesk A360](#)  
[etoolbox Mobile CAD Viewer](#)

**DESCRIPTION**

Less is more BeamLine Systems  
Ceiling luminaire, MRS-Technology  
Color: black  
Anti glare frame: black  
Light distribution: medium wide 30°  
CRI: ≥ 90  
Luminous flux: ca. 2000 lm/m  
Type of protection: IP 20  
Protection class: I  
Color temperature: 4000 K  
Dimmable: DALI  
LED rated life: 50.000 L80B10

Housing: extruded aluminium profile, powder-coated. End cap aluminium powder-coated. LED light unit with MRS technology: Mini-Reflector-System made of metallised thermoplastic with prismatic black glare-suppressing frame for pleasant glare-free light (UGR < 10).

...listo para proyectar!

10

# BEAMLINE SLIM

Tecnología

Fijación en el techo mediante sistema de muelles

Cada módulo LED se compone de 5, 10 o 15 mini reflectores



Instalación muy sencilla gracias a la conexión plug & play



Efecto darklight



Módulo LED con tecnología MRS: sistema de mini reflectores hechos de termoplástico metalizado con marco antideslumbrante prismático negro, para una iluminación agradable sin deslumbramiento (UGR < 10)



La reproducción del color **Ra 90** para una percepción realista

# BEAMLINE SLIM

Todo de un vistazo

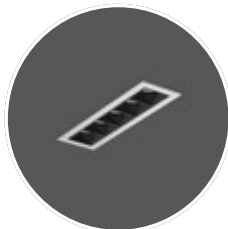

## 3 LONGITUDES

- » 155 mm
- » 295 mm
- » 435 mm



## 3 DISTRIBUCIONES DE LA LUZ

- » haz intensivo
- » haz medio
- » haz extensivo



## 4 COLORES

- » blanco con marco antideslumbrante negro
- » plata con marco antideslumbrante negro
- » negro con marco antideslumbrante negro
- » blanco con marco antideslumbrante blanco

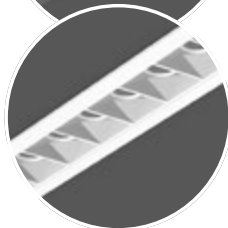



## DATOS FOTOMÉTRICOS

- ⊕ Tecnología MRS para una iluminación agradable sin delumbramiento ( $UGR < 10$ )
- ⊕ Disponible en tres haces de luz (intensivo, medio o extensivo) que permite un uso flexible
- ⊕ Efecto darklight
- ⊕ Índice de reproducción cromática:  $Ra \geq 90$
- ⊕ Vida útil de LED: aprox. 50.000 h (L80/B10)
- ⊕ Tolerancias cromáticas mínimas, triple MacAdam (3 SDCM)

# BEAMLIN SLIM

## Descripción del producto | Luminarias empotrables en techo

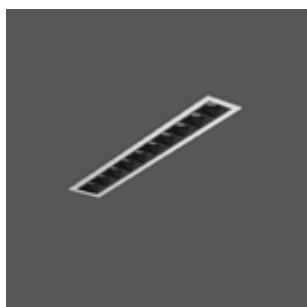

### Luminarias empotrables en techo | BeamLine Slim

Tipo de Protección: IP 20  
 Clase de Protección: II  
 Espesor de techo S: 1-50 mm  
 Protección contra golpes: IK03

Carcasa de metal revestido al polvo. Perfecta gestión térmica gracias al módulo de refrigeración de aluminio. Módulo LED con **tecnología MRS**: sistema de mini reflectores hechos de termoplástico metalizado con marco antideslumbrante prismático negro, para una iluminación agradable sin deslumbramiento (UGR < 10). Disponible en tres haces de luz (intensivo, medio o extensivo) que permite un uso flexible. Fijación en el techo mediante sistema de muelles. Incl. convertidor externo con conector. Línea de conexión 450 mm.

Colores disponibles (X): 2 = blanco, 3 = negro, 4 = color plateado

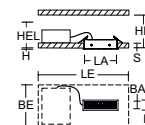

Nº artículo	Dimensiones [mm]	Fuente de luz	Color de la luz	Flujo luminoso de la luminaria [lm]	Potencia luminaria [W]	UGR	Regulación
<b>Luminarias empotrables en techo</b>							
<b>Categoría de Precios 21</b>							
<b>Haz intensivo 10°</b>							
<b>Longitud 155 mm, LA 150 x BA 40 mm, HE 110 mm</b>							
641323.00X	L 155, B 45, H 2, HEL 60	LED	927	900	14	3,1	on/off
641323.00X.76	L 155, B 45, H 2, HEL 60	LED	927	900	14	3,1	DALI
641323.00X.1	L 155, B 45, H 2, HEL 60	LED	930	980	14	3,5	on/off
641323.00X.1.76	L 155, B 45, H 2, HEL 60	LED	930	980	14	3,5	DALI
641323.00X.2	L 155, B 45, H 2, HEL 60	LED	940	1050	14	3,5	on/off
641323.00X.2.76	L 155, B 45, H 2, HEL 60	LED	940	1050	14	3,5	DALI
<b>Longitud 295 mm, LA 290 x BA 40 mm, HE 110 mm</b>							
641326.00X	L 295, B 45, H 2, HEL 60	LED	927	1800	25	3,1	on/off
641326.00X.76	L 295, B 45, H 2, HEL 60	LED	927	1800	25	3,1	DALI
641326.00X.1	L 295, B 45, H 2, HEL 60	LED	930	1950	25	3,5	on/off
641326.00X.1.76	L 295, B 45, H 2, HEL 60	LED	930	1950	25	3,5	DALI
641326.00X.2	L 295, B 45, H 2, HEL 60	LED	940	2100	25	3,5	on/off
641326.00X.2.76	L 295, B 45, H 2, HEL 60	LED	940	2100	25	3,5	DALI
<b>Longitud 435 mm, LA 430 x BA 40 mm, HE 110 mm</b>							
641329.00X	L 435, B 45, H 2, HEL 60	LED	927	2700	36	3,1	on/off
641329.00X.76	L 435, B 45, H 2, HEL 60	LED	927	2700	36	3,1	DALI
641329.00X.1	L 435, B 45, H 2, HEL 60	LED	930	2950	36	3,5	on/off
641329.00X.1.76	L 435, B 45, H 2, HEL 60	LED	930	2950	36	3,5	DALI
641329.00X.2	L 435, B 45, H 2, HEL 60	LED	940	3150	36	3,5	on/off
641329.00X.2.76	L 435, B 45, H 2, HEL 60	LED	940	3150	36	3,5	DALI
<b>Haz medio 30°</b>							
<b>Longitud 155 mm, LA 150 x BA 40 mm, HE 110 mm</b>							
641324.00X	L 155, B 45, H 2, HEL 60	LED	927	940	14	5,7	on/off
641324.00X.76	L 155, B 45, H 2, HEL 60	LED	927	940	14	5,7	DALI
641324.00X.1	L 155, B 45, H 2, HEL 60	LED	930	1000	14	5,4	on/off
641324.00X.1.76	L 155, B 45, H 2, HEL 60	LED	930	1000	14	5,4	DALI
641324.00X.2	L 155, B 45, H 2, HEL 60	LED	940	1100	14	5,9	on/off
641324.00X.2.76	L 155, B 45, H 2, HEL 60	LED	940	1100	14	5,9	DALI
<b>Longitud 295 mm, LA 290 x BA 40 mm, HE 110 mm</b>							
641327.00X	L 295, B 45, H 2, HEL 60	LED	927	1900	25	5,7	on/off
641327.00X.76	L 295, B 45, H 2, HEL 60	LED	927	1900	25	5,7	DALI
641327.00X.1	L 295, B 45, H 2, HEL 60	LED	930	2050	25	5,4	on/off
641327.00X.1.76	L 295, B 45, H 2, HEL 60	LED	930	2050	25	5,4	DALI
641327.00X.2	L 295, B 45, H 2, HEL 60	LED	940	2150	25	5,9	on/off
641327.00X.2.76	L 295, B 45, H 2, HEL 60	LED	940	2150	25	5,9	DALI
<b>Longitud 435 mm, LA 430 x BA 40 mm, HE 110 mm</b>							
641330.00X	L 435, B 45, H 2, HEL 60	LED	927	2800	36	5,7	on/off
641330.00X.76	L 435, B 45, H 2, HEL 60	LED	927	2800	36	5,7	DALI
641330.00X.1	L 435, B 45, H 2, HEL 60	LED	930	3050	36	5,4	on/off
641330.00X.1.76	L 435, B 45, H 2, HEL 60	LED	930	3050	36	5,4	DALI
641330.00X.2	L 435, B 45, H 2, HEL 60	LED	940	3250	36	5,9	on/off
641330.00X.2.76	L 435, B 45, H 2, HEL 60	LED	940	3250	36	5,9	DALI

Nº artículo	Dimensiones [mm]	Fuente de luz	Color de la luz	Flujo luminoso de la luminaria [lm]	Potencia luminaria [W]	UGR	Regulación
<b>Luminarias empotrables en techo</b>							
<b>Categoría de Precios 21</b>							
<b>Haz extensivo 50°</b>							
<b>Longitud 155 mm, LA 150 x BA 40 mm, HE 110 mm</b>							
641325.00X	L 155, B 45, H 2, HEL 60	LED	927	960	14	9,5	on/off
641325.00X.76	L 155, B 45, H 2, HEL 60	LED	927	960	14	9,5	DALI
641325.00X.1	L 155, B 45, H 2, HEL 60	LED	930	1050	14	9,5	on/off
641325.00X.1.76	L 155, B 45, H 2, HEL 60	LED	930	1050	14	9,5	DALI
641325.00X.2	L 155, B 45, H 2, HEL 60	LED	940	1100	14	9,4	on/off
641325.00X.2.76	L 155, B 45, H 2, HEL 60	LED	940	1100	14	9,4	DALI
<b>Longitud 295 mm, LA 290 x BA 40 mm, HE 110 mm</b>							
641328.00X	L 295, B 45, H 2, HEL 60	LED	927	1900	25	9,5	on/off
641328.00X.76	L 295, B 45, H 2, HEL 60	LED	927	1900	25	9,5	DALI
641328.00X.1	L 295, B 45, H 2, HEL 60	LED	930	2050	25	9,4	on/off
641328.00X.1.76	L 295, B 45, H 2, HEL 60	LED	930	2050	25	9,4	DALI
641328.00X.2	L 295, B 45, H 2, HEL 60	LED	940	2200	25	9,4	on/off
641328.00X.2.76	L 295, B 45, H 2, HEL 60	LED	940	2200	25	9,4	DALI
<b>Longitud 435 mm, LA 430 x BA 40 mm, HE 110 mm</b>							
641331.00X	L 435, B 45, H 2, HEL 60	LED	927	2900	36	9,5	on/off
641331.00X.76	L 435, B 45, H 2, HEL 60	LED	927	2900	36	9,5	DALI
641331.00X.1	L 435, B 45, H 2, HEL 60	LED	930	3100	36	9,5	on/off
641331.00X.1.76	L 435, B 45, H 2, HEL 60	LED	930	3100	36	9,5	DALI
641331.00X.2	L 435, B 45, H 2, HEL 60	LED	940	3350	36	9,5	on/off
641331.00X.2.76	L 435, B 45, H 2, HEL 60	LED	940	3350	36	9,5	DALI

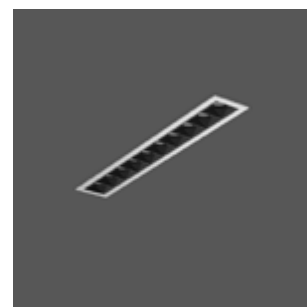

2 = blanco



3 = negro



4 = color plateado

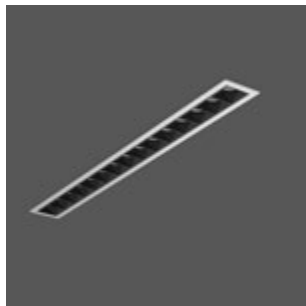
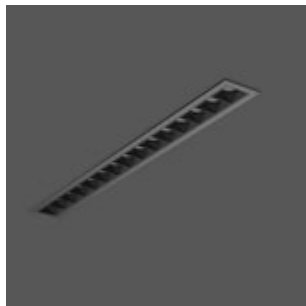
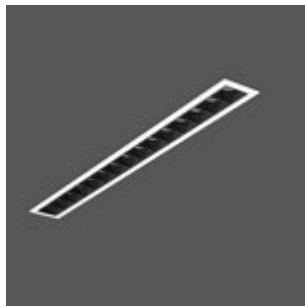
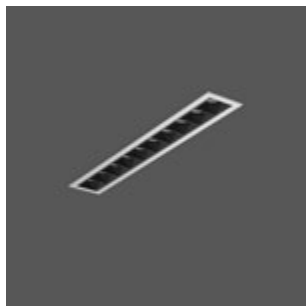
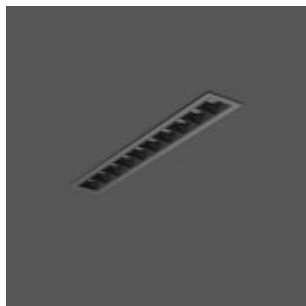
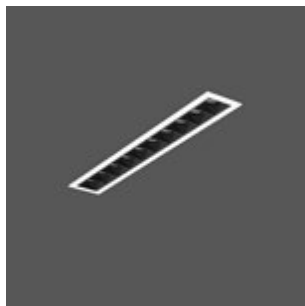
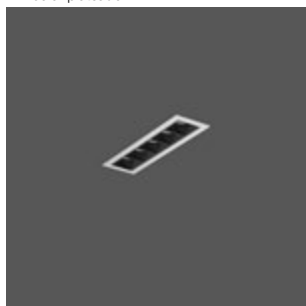

# BEAMLIN SLIM

## Descripción del producto | Luminarias empotrables en techo



### Luminarias empotrables en techo | BeamLine Slim

Tipo de Protección: IP 20  
 Clase de Protección: II  
 Espesor de techo S: 1-50 mm  
 Protección contra golpes: IK03

Carcasa de metal revestido al polvo. Perfecta gestión térmica gracias al módulo de refrigeración de aluminio. Módulo LED con **tecnología MRS**: sistema de mini reflectores hechos de termoplástico metalizado con marco antideslumbrante prismático blanco, para una iluminación agradable sin deslumbramiento (UGR < 10). Disponible en tres haces de luz (intensivo, medio o extensivo) que permite un uso flexible. Fijación en el techo mediante sistema de muelles. Incl. convertidor externo con conector. Línea de conexión 450 mm.

Color disponible: blanco

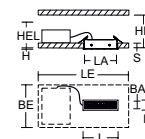

Nº artículo	Dimensiones [mm]	Fuente de luz	Color de la luz	Flujo luminoso de la luminaria [lm]	Potencia luminaria [W]	UGR	Regulación
<b>Luminarias empotrables en techo</b>							
<b>Categoría de Precios 21</b>							
	<b>Haz intensivo 10°</b>						
<b>Longitud 155 mm, LA 150 x BA 40 mm, HE 110 mm</b>							
641323.0025	L 155, B 45, H 2, HEL 60	LED	927	900	14	3,1	on/off
641323.0025.76	L 155, B 45, H 2, HEL 60	LED	927	900	14	3,1	DALI
641323.0025.1	L 155, B 45, H 2, HEL 60	LED	930	980	14	3,5	on/off
641323.0025.1.76	L 155, B 45, H 2, HEL 60	LED	930	980	14	3,5	DALI
641323.0025.2	L 155, B 45, H 2, HEL 60	LED	940	1050	14	3,5	on/off
641323.0025.2.76	L 155, B 45, H 2, HEL 60	LED	940	1050	14	3,5	DALI
<b>Longitud 295 mm, LA 290 x BA 40 mm, HE 110 mm</b>							
641326.0025	L 295, B 45, H 2, HEL 60	LED	927	1800	25	3,1	on/off
641326.0025.76	L 295, B 45, H 2, HEL 60	LED	927	1800	25	3,1	DALI
641326.0025.1	L 295, B 45, H 2, HEL 60	LED	930	1950	25	3,5	on/off
641326.0025.1.76	L 295, B 45, H 2, HEL 60	LED	930	1950	25	3,5	DALI
641326.0025.2	L 295, B 45, H 2, HEL 60	LED	940	2100	25	3,5	on/off
641326.0025.2.76	L 295, B 45, H 2, HEL 60	LED	940	2100	25	3,5	DALI
<b>Longitud 435 mm, LA 430 x BA 40 mm, HE 110 mm</b>							
641329.0025	L 435, B 45, H 2, HEL 60	LED	927	2700	36	3,1	on/off
641329.0025.76	L 435, B 45, H 2, HEL 60	LED	927	2700	36	3,1	DALI
641329.0025.1	L 435, B 45, H 2, HEL 60	LED	930	2950	36	3,5	on/off
641329.0025.1.76	L 435, B 45, H 2, HEL 60	LED	930	2950	36	3,5	DALI
641329.0025.2	L 435, B 45, H 2, HEL 60	LED	940	3150	36	3,5	on/off
641329.0025.2.76	L 435, B 45, H 2, HEL 60	LED	940	3150	36	3,5	DALI
	<b>Haz medio 30°</b>						
<b>Longitud 155 mm, LA 150 x BA 40 mm, HE 110 mm</b>							
641324.0025	L 155, B 45, H 2, HEL 60	LED	927	940	14	5,7	on/off
641324.0025.76	L 155, B 45, H 2, HEL 60	LED	927	940	14	5,7	DALI
641324.0025.1	L 155, B 45, H 2, HEL 60	LED	930	1000	14	5,4	on/off
641324.0025.1.76	L 155, B 45, H 2, HEL 60	LED	930	1000	14	5,4	DALI
641324.0025.2	L 155, B 45, H 2, HEL 60	LED	940	1100	14	5,9	on/off
641324.0025.2.76	L 155, B 45, H 2, HEL 60	LED	940	1100	14	5,9	DALI
<b>Longitud 295 mm, LA 290 x BA 40 mm, HE 110 mm</b>							
641327.0025	L 295, B 45, H 2, HEL 60	LED	927	1900	25	5,7	on/off
641327.0025.76	L 295, B 45, H 2, HEL 60	LED	927	1900	25	5,7	DALI
641327.0025.1	L 295, B 45, H 2, HEL 60	LED	930	2050	25	5,4	on/off
641327.0025.1.76	L 295, B 45, H 2, HEL 60	LED	930	2050	25	5,4	DALI
641327.0025.2	L 295, B 45, H 2, HEL 60	LED	940	2150	25	5,9	on/off
641327.0025.2.76	L 295, B 45, H 2, HEL 60	LED	940	2150	25	5,9	DALI
<b>Longitud 435 mm, LA 430 x BA 40 mm, HE 110 mm</b>							
641330.0025	L 435, B 45, H 2, HEL 60	LED	927	2800	36	5,7	on/off
641330.0025.76	L 435, B 45, H 2, HEL 60	LED	927	2800	36	5,7	DALI
641330.0025.1	L 435, B 45, H 2, HEL 60	LED	930	3050	36	5,4	on/off
641330.0025.1.76	L 435, B 45, H 2, HEL 60	LED	930	3050	36	5,4	DALI
641330.0025.2	L 435, B 45, H 2, HEL 60	LED	940	3250	36	5,9	on/off
641330.0025.2.76	L 435, B 45, H 2, HEL 60	LED	940	3250	36	5,9	DALI



Nº artículo	Dimensiones [mm]	Fuente de luz	Color de la luz	Flujo luminoso de la luminaria [lm]	Potencia luminaria [W]	UGR	Regulación
<b>Luminarias empotrables en techo</b>							
<b>Categoría de Precios 21</b>							
<b>Haz extensivo 50°</b>							
<b>Longitud 155 mm, LA 150 x BA 40 mm, HE 110 mm</b>							
641325.0025	L 155, B 45, H 2, HEL 60	LED	927	960	14	9,5	on/off
641325.0025.76	L 155, B 45, H 2, HEL 60	LED	927	960	14	9,5	DALI
641325.0025.1	L 155, B 45, H 2, HEL 60	LED	930	1050	14	9,5	on/off
641325.0025.1.76	L 155, B 45, H 2, HEL 60	LED	930	1050	14	9,5	DALI
641325.0025.2	L 155, B 45, H 2, HEL 60	LED	940	1100	14	9,4	on/off
641325.0025.2.76	L 155, B 45, H 2, HEL 60	LED	940	1100	14	9,4	DALI
<b>Longitud 295 mm, LA 290 x BA 40 mm, HE 110 mm</b>							
641328.0025	L 295, B 45, H 2, HEL 60	LED	927	1900	25	9,5	on/off
641328.0025.76	L 295, B 45, H 2, HEL 60	LED	927	1900	25	9,5	DALI
641328.0025.1	L 295, B 45, H 2, HEL 60	LED	930	2050	25	9,4	on/off
641328.0025.1.76	L 295, B 45, H 2, HEL 60	LED	930	2050	25	9,4	DALI
641328.0025.2	L 295, B 45, H 2, HEL 60	LED	940	2200	25	9,4	on/off
641328.0025.2.76	L 295, B 45, H 2, HEL 60	LED	940	2200	25	9,4	DALI
<b>Longitud 435 mm, LA 430 x BA 40 mm, HE 110 mm</b>							
641331.0025	L 435, B 45, H 2, HEL 60	LED	927	2900	36	9,5	on/off
641331.0025.76	L 435, B 45, H 2, HEL 60	LED	927	2900	36	9,5	DALI
641331.0025.1	L 435, B 45, H 2, HEL 60	LED	930	3100	36	9,5	on/off
641331.0025.1.76	L 435, B 45, H 2, HEL 60	LED	930	3100	36	9,5	DALI
641331.0025.2	L 435, B 45, H 2, HEL 60	LED	940	3350	36	9,5	on/off
641331.0025.2.76	L 435, B 45, H 2, HEL 60	LED	940	3350	36	9,5	DALI

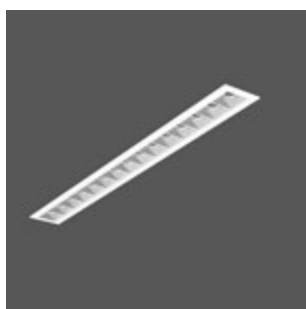
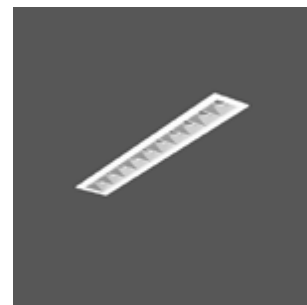



DIE STADT STEHT  
IHNEN OFFEN.



Small informational card or brochure placed on the wooden ledge.

## OTRAS LUMINARIA, PARA ACOMPAÑAR ESTA SERIE:



⊕ Less is more® 21

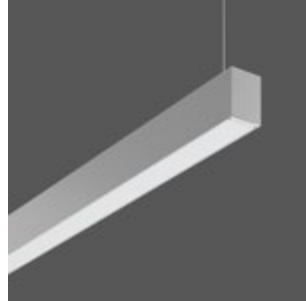

⊕ Less is more® 27



⊕ Less is more® 50



⊕ Less is more® Systeme

## SISTEMA DE GESTIÓN DE ILUMINACIÓN, PARA ACOMPAÑAR ESTA SERIE:



⊕ light control +³ Economy  
Blu2Light

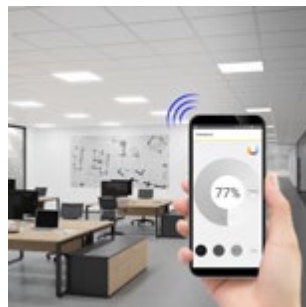

⊕ light control +³ Economy  
Multi DALI



⊕ light control +³ Professional  
Control

## ALTA CALIDAD DE PRODUCTO Y ASESORAMIENTO

### ⊕ SEGURIDAD

Nosotros somos su fiable socio. Le acompañamos desde la primera idea hasta la realización de su proyecto, y más allá. Con personalidad, con pasión, con atención individual. Respondemos a las altas exigencias de todos los implicados en el proceso de planificación con nuestra excelente profesionalidad, la alta calidad de los productos y nuestros servicios, como la planificación luminotécnica, estudio de rentabilidad y puesta en marcha.

- ✓ confección de archivos BIM
- ✓ montaje fácil y rápido
- ✓ calidad y largos periodos de garantía

### ⊕ GARANTÍA

La fabricación de componentes lumínicos de alta calidad es nuestra pasión. Nuestros productos son resultado de un desarrollo y procesamiento de máxima precisión.

Junto a las nociones de SMART TECHNOLOGY y EXCELLENT DESIGN, perseguimos el reto de producir luminarias de la más alta calidad en todas las fases de la cadena de valor hasta llegar al servicio posventa.

Por convicción le ofrecemos ahora en función de lo anterior, y también SIN el registro previo, 5 años de garantía de fabricación en luminarias LED y 2 años de garantía en luminarias de emergencia a partir de la fecha de compra del producto.

Condiciones de garantía: véase la página

[www.rzb.de/es/servicios/garantia-en-luminarias-led/](http://www.rzb.de/es/servicios/garantia-en-luminarias-led/)

## RZB – OPCIÓN DE VALOR AÑADIDO



**RZB  
Rudolf Zimmermann,  
Bamberg GmbH**

Rheinstr. 16  
96052 Bamberg  
Alemania

Teléfono +49 951 7909-374

[www.rzb-lighting.com](http://www.rzb-lighting.com)  
[export@rzb.eu](mailto:export@rzb.eu)

**RZB España**

C/ Monasterio de las Huelgas, 23  
Oficina 9  
50014 Zaragoza

Teléfono +34 976 45 11 30

[www.rzb.es](http://www.rzb.es)  
[info.espana@rzb.eu](mailto:info.espana@rzb.eu)

