

INSTRUCTION

Rounded Midi
582107.0031.19



~ 220 - 240 V 50/60 Hz IP 66, IP 66 IK10



 3 x 0,75 - 2,5 mm²



Umgebungstemperatur /
temperature ambiante
=> -20 °C ... + 45 °C

 2,50 mm²

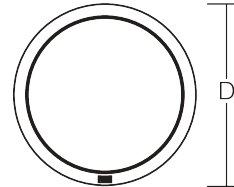

D 300, H 71



1,89 kg



Φ_{B} [lm]

P_{B} [W]

P_{L}

LED

440

4,5

1 x 4 W

CCT [K]

CRI

RG $\text{\textcircled{B}}$

EEK 

3000

80

RG 1

D

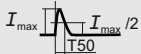

$\text{COS } \varphi$

5 A / 150 μ s

0,93

$f_{\text{min}} - f_{\text{max}}$
[MHz]

p_{EIRP} [mW]

5725 - 5875

0,2





Installation erfordert
Elektro-Fachkraft!

Symbole nach ISO 7010



Allgemeine Sicherheitshinweise

- Der elektrische Anschluss muss ordnungsgemäß nach geltenden Normen und den nationalen sowie internationalen Sicherheits- und Unfallverhütungsvorschriften erfolgen.
- Beschädigte Leuchten dürfen nicht betrieben werden.
- Keine Haftung für Schäden durch unsachgemäßen Einsatz.
- Bei Instandsetzung nur Originalteile verwenden.
- Tragfähigkeit der Decke und Befestigungselemente sicherstellen.

Betrieb der Leuchte

- Die unzulässigen Umgebungstemperaturen reduzieren die Lebensdauer der Leuchte, im Extremfall droht der Frühausfall.
- Zur Vermeidung von EMV-Problemen die Durchgangsverdrahtung nicht entlang der Leuchtenverdrahtung führen.
- Steuereingänge von dimmbaren Leuchten mit handelsüblichen für Netzspannung geeigneten Leitungen anschließen.

Manipulationen unserer Produkte sind unzulässig

Veränderung, Umarbeitung, Umkennzeichnung von Produkten sowie deren Verpackung sind unzulässig und verletzen u.a. unsere eingetragenen Warenzeichenrechte. Solche Modifikationen können technische Eigenschaften unserer Produkte negativ beeinflussen, diese zerstören und möglicherweise Folgeschäden an anderen Objekten verursachen. Für durch derartige Modifikationen verursachte Schäden kann der Hersteller in keinem Fall verantwortlich gemacht werden.



Installation requires
a qualified electrician!

Symbols according
to ISO 7010



General Safety Information

- Electric connection must be appropriate according to all applicable standards and other national and international safety and accident prevention regulations.
- Damaged luminaires must not be operated.
- No liability is accepted for damages resulting from improper use.
- Use genuine parts only for repair.
- Ensure stability of the ceiling and fastening elements.

Operation of the luminaire

- Exceeding the permissible ambient temperature will reduce the luminaire's lifecycle, resulting in premature failure in extreme cases.
- Avoid ESD problems by not routing feed-through wiring directly along the wiring of the luminaire.
- Connect control inputs of dimmable luminaires with standard cables suitable for power supply voltage.

Manipulation of our products is not permitted

Modifications, reworking, re-labelling of products as well as their package is not permitted and infringes, amongst others, our registered trademark rights. Such modifications may affect technical properties of our products, damage them and possibly cause consequential damage to other objects. The manufacturer shall not be responsible under any circumstances for damage caused by such modifications.



Bei Fragen zu unseren Symbolen, besuchen Sie folgende Webseite:
 If you have any questions about our signs, visit the following website:

https://www.rzb.de/fileadmin/assets/downloads/PDF/RZB_Symbolklaerung.pdf

EEK

Dieses Produkt enthält eine Lichtquelle der Energieeffizienzklasse D entsprechend Verordnung (EU) 2019/2015

This product contains a light source of energy efficiency class D according to regulation (EU) No 2019/2015

Jede zersprungene Schutzabdeckung ist zu ersetzen. DIN EN 60598

Replace any cracked protective shield. IEC DIN EN 60598

Hinweis zum Einsatz von Leuchten mit D - Kennzeichnung nach EN 60598-2-24
 Reference for application of lumiaires with D - marking according to EN 60598-2-24

<p>IP 4x</p>	<p><u>Umgebung ohne Staubablagerung</u> Environment without dust deposit</p>
<p>IP 5x</p>	<p><u>Umgebung mit nicht elektrisch leitender Staubablagerung</u> Environment with non-electrically conductive dust deposit</p>
<p>IP 6x</p>	<p><u>Umgebung mit elektrisch leitender Staubablagerung</u> Environment with electrically conductive dust deposit</p>



Der Abstand zu beleuchteten Gegenständen muss min. 1 m betragen!

The distance to the direct illuminated objects must be at least 1 m!



IP 66



IP 66

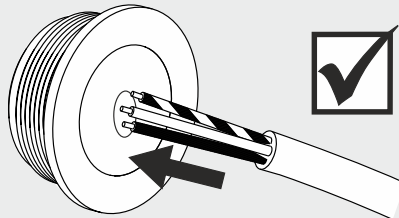
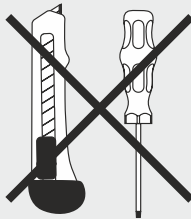
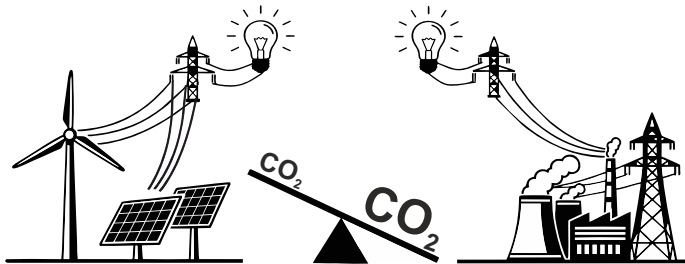



DIP-Schalter-Einstellungen / DIP Switch Settings

1 Erfassungsbereich / Detection Range

Die Sensorempfindlichkeit kann durch Auswahl der Kombination an den DIP-Schaltern genau auf die jeweilige Anwendung eingestellt werden.

The sensor sensitivity can be adjusted by selecting the combination at the DIP switches to exactly match the respective application by selecting the combination on the DIP switches.

	1	2	
I	●	●	100%
II	●	○	75%
III	○	●	50%
IV	○	○	10%

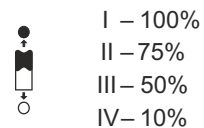

2 Haltezeit / Hold Time

Wählen Sie den DIP-Schalter für die Einschaltzeit des Lichts nach der Anwesenheit-Erkennung. Diese Funktion ist deaktiviert, wenn das natürliche Licht ausreicht.

Select the DIP switch configuration for the light on-time after presence detection. This function is disabled when natural light is sufficient.

	3	4	
I	●	●	5s
II	●	○	90s
III	○	●	5min
IV	○	○	15min

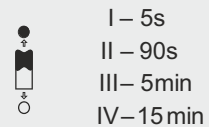

3 Tageslicht-Schwellenwert / Daylight Threshold

Stellen Sie den Pegel entsprechend der Beschaffenheit und der Umgebung ein. Das Licht schaltet sich nicht ein, wenn die Umgebungshelligkeit den eingestellten Schwellenwert für Tageslicht überschreitet. Bitte beachten Sie, dass sich die Umgebungsluxwerte auf das interne Licht beziehen, das den Sensor erreicht. Durch die Deaktivierung des Tageslichtsensors wird der Sensor in den Modus versetzt.

Set the level according to the fixture and environment. The light will not turn on if ambient lux level exceeds the daylight threshold preset. Please note that the ambient lux level refers to internal light reaching the sensor. Disabling the daylight sensor will put the sensor into occupancy detection only mode.

	5	6	
I	●	●	Disabl
II	●	○	50Lux
III	○	●	10Lux
IV	○	○	2Lux

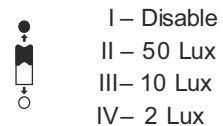

**Funktionsparameter: HF-Bewegungsmelder HC007S**

- HF-Melder 5,8 GHz ISM Frequenzband
- Haltezeit 5 Sek. - 15 Min.; in 4 Stufen einstellbar
- Erfassungswinkel 30° - 150°
- Reichweite bis Ø8 m; Empfindlichkeit in 4 Stufen einstellbar
- Werkeinstellung: Haltezeit 5 Sek., Reichweite ca. Ø8 m



Helligkeitssensor / Tageslichtfunktion bauartbedingt nicht nutzbar
Erfassungsbereich kann je nach Einbausituation abweichen

Functional parameters: HF movement sensor HC007S

- HF sensor 5,8 GHz ISM frequency
- Hold time 5 sec. - 15 min.; adjustable in 4 levels
- Detection range 30° - 150°
- Range up to Ø8 m; sensitivity adjustable in 4 levels
- Factory setting: Hold time 5 sec., range approx. Ø8 m



Brightness sensor / daylight function cannot be used due to the design
Detection range may vary depending on the installation situation

Ersatzteil

Spare part

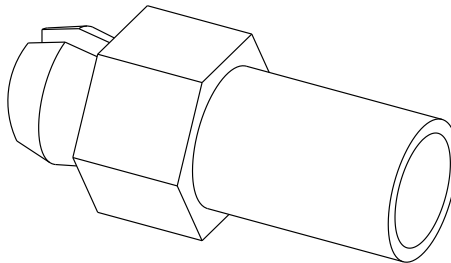
2x



EG-Konformitätserklärung
EC-Declaration of Conformity
Déclaration UE de conformité
Declaración de conformidad CE
Deklaracja zgodności UE



Hersteller, Anschrift:
Manufacturer, address:
Fabricant, adresse:
Fabricante, dirección:
Producent, adres:

RZB Rudolf Zimmermann, Bamberg GmbH
Rheinstrasse 16
96052 Bamberg
Deutschland / Germany / Allemagne / Alemania / Niemcy

Wir erklären in alleiniger Verantwortung, dass das Produkt
 We declare under sole responsibility that the product
 Nous déclarons, sous notre propre responsabilité, que le produit
 Declaramos bajo nuestra sola responsabilidad que el producto
 Deklarujemy z pełną odpowiedzialnością, że produkt

Produktbezeichnung:
Product designation: **Rounded Midi**
Description des produits:
Designación de producto: **582107.0031.19**
Oznaczenie produktu:

mit den folgenden EG-Richtlinien und Normen übereinstimmt:
 complies with the following EC Directives and standards:
 est conforme aux normes et directives de l'UE suivantes:
 cumple con las siguientes directivas y normas CE:
 jest zgodny z następującymi dyrektywami UE i normami:

<p>RED Directive 2014/53/EU</p>	<p>(3.1a) EN 50663:2017 EN 60598-1:2021/A11:2022 EN 60598-2-1:1989 EN 62471:2008 EN 62493:2010 (3.1b) EN 301 489-1:V2.2.3 EN 301 489-3:V2.3.2 EN 55015:2019/A11:2020 EN 61000-3-2:2019/A1:2021 EN 61000-3-3:2013+A1:2019+A2:2021+A2:2021/AC:2022 EN 61547:2023 (3.2) EN 300 440:V2.1.1</p>
<p>RoHS Directive 2011/65/EU</p>	<p>EN 63000:2018</p>
<p>ErP Directive 2009/125/EC</p>	<p>(EU) 2019/2020</p>

Dokument-Nr. / Document No. / Document No. **24002400**
 Document No. / Nr dokumentu

Aussteller / Issuer / Délivré par: **RZB Rudolf Zimmermann, Bamberg GmbH**
 Otorgante / Wystawca:

Ort, Datum / Place, Date / Lieu, date: **Bamberg, 02.02.2024**
 Lugar, Fecha / Miejsce, data:

Rechtsverbindliche Unterschrift:
 Legally binding signature:
 Signature juridiquement obligatore:
 Firma legalmente vinculante:
 Prawnie wiązacy podpis:

 Reiner Jürgens
 CEO/Direktor Zarządzający/Geschäftsführer

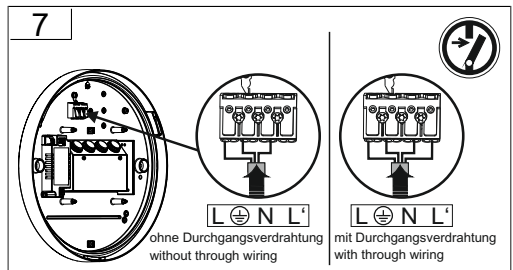
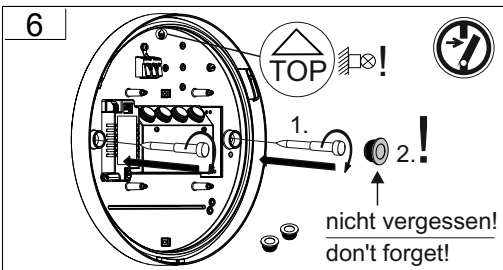
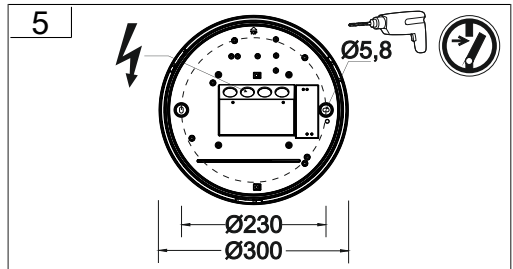
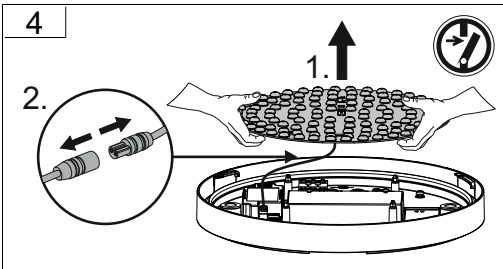
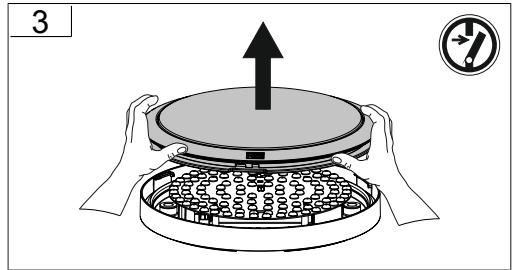
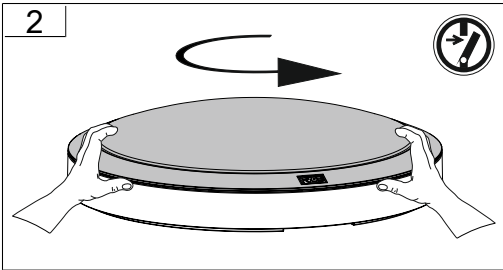
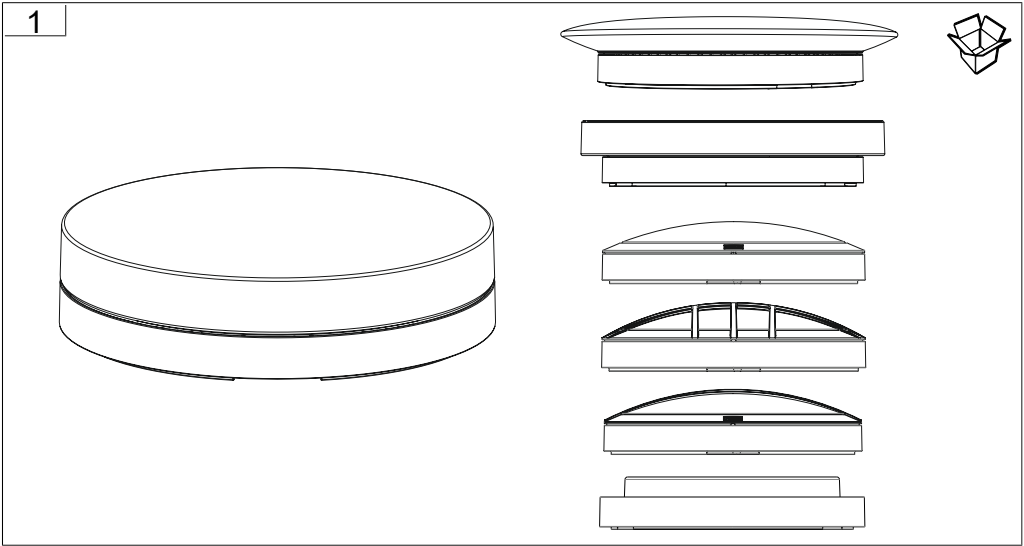

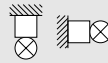

8

Konvertereinstellung / Converter setting

Iout	Pout	1	2	
90 mA	3,8W	-	-	3000K → 440-450lm
140 mA	5,9W	-	ON	4000K → 450-460lm
190 mA	8W	ON	-	3000K → 1100-1150lm
240 mA	10,1W	ON	ON	4000K → 1150-1150lm

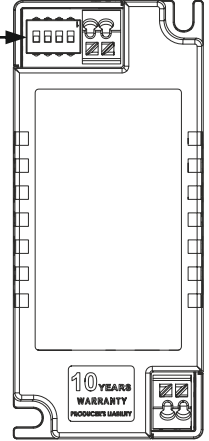

9

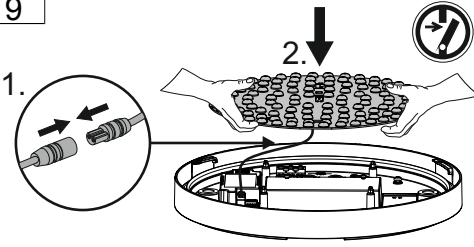

10

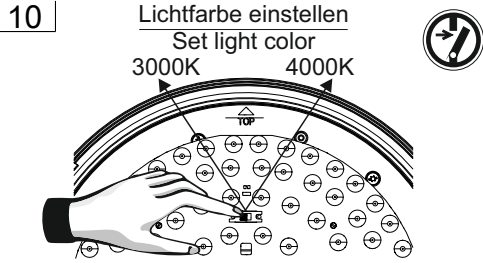

11

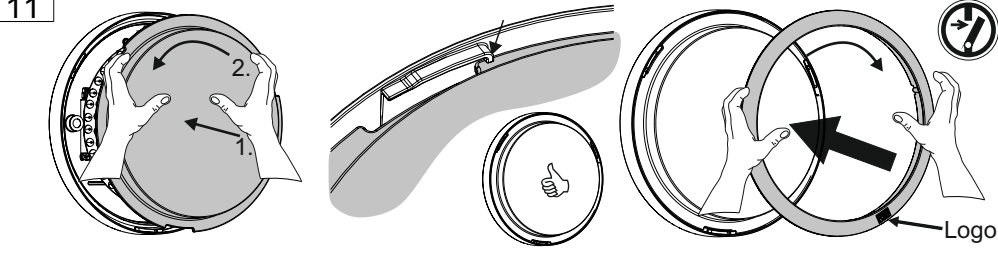

12

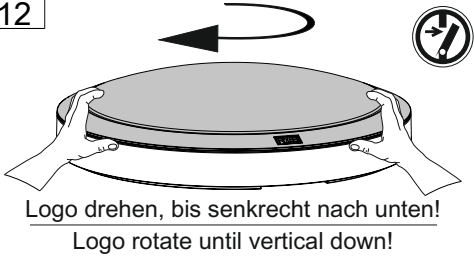

13

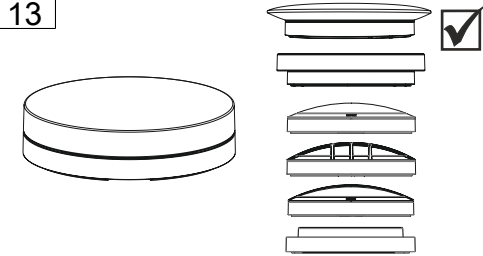

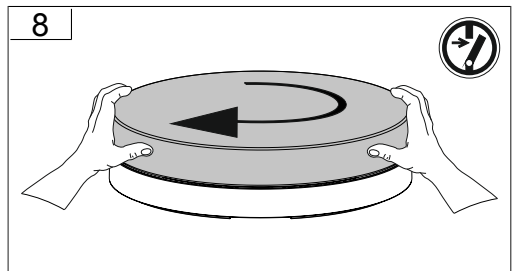
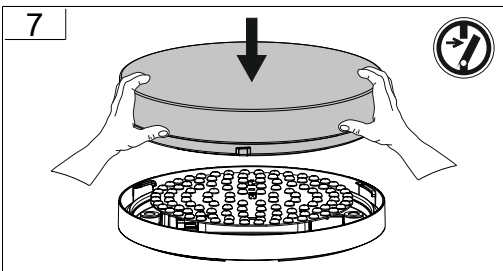
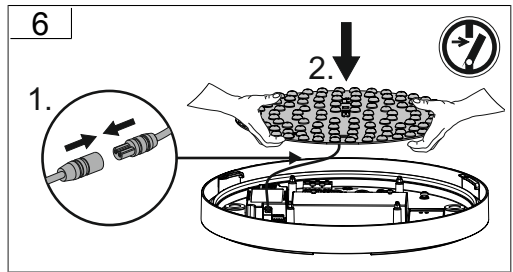
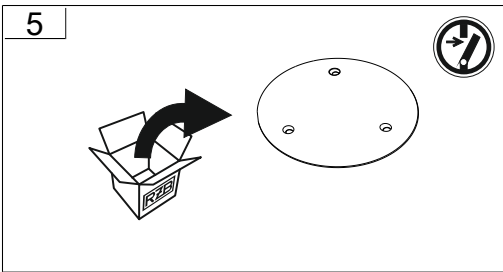
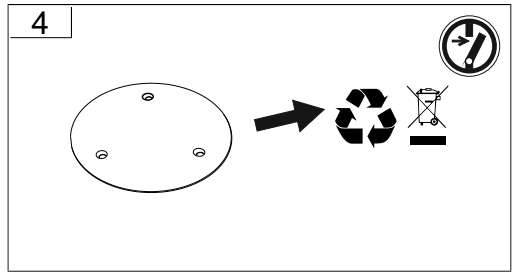
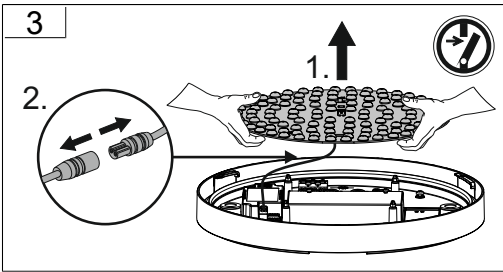
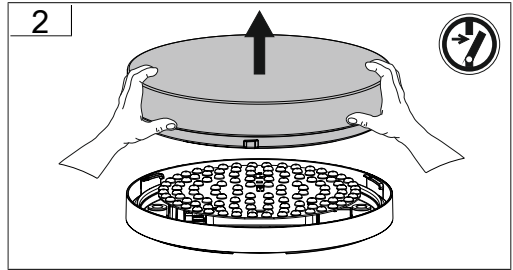
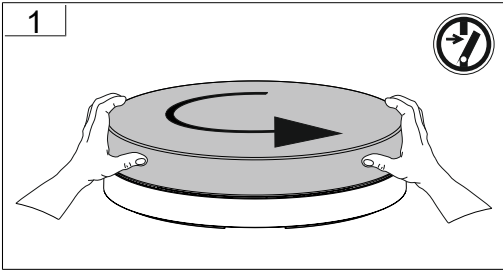

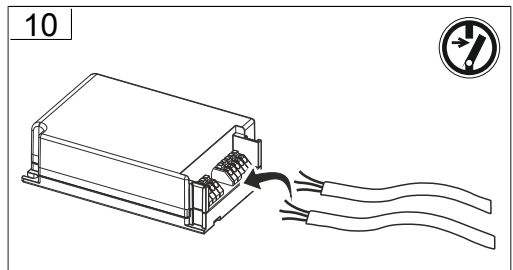
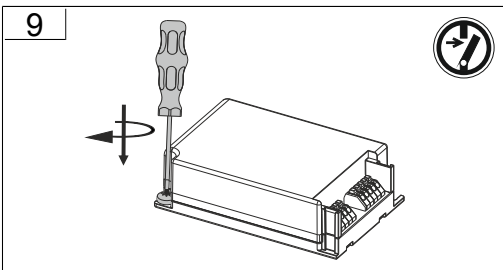
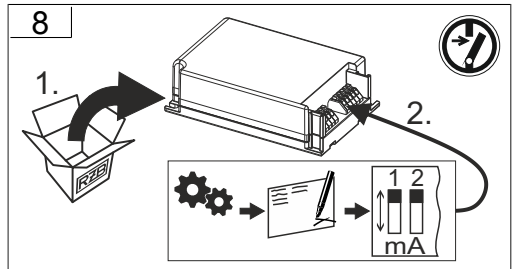
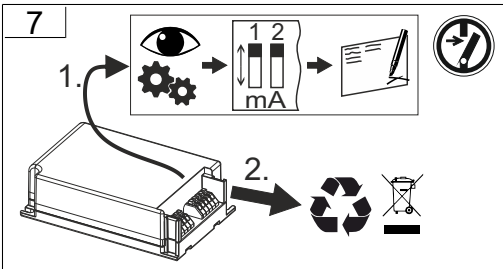
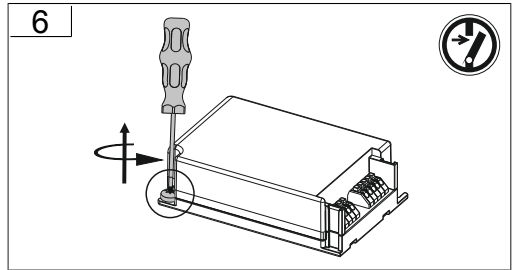
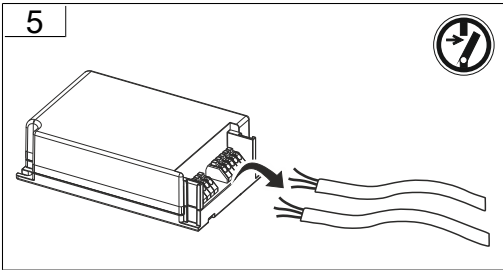
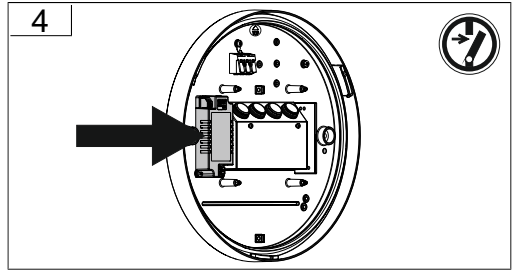
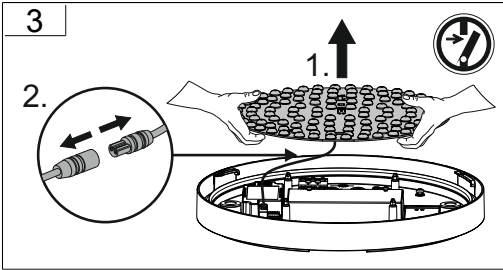
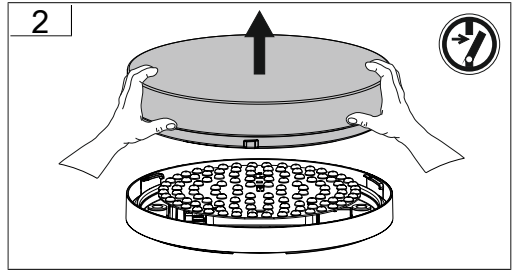
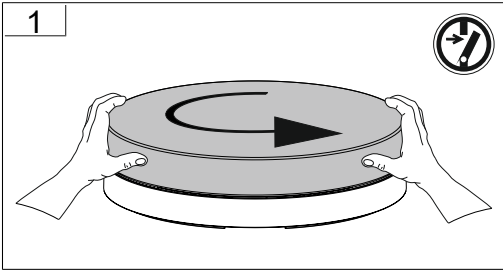

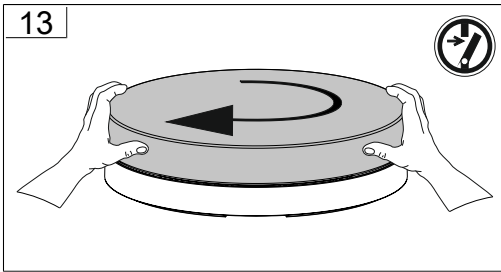
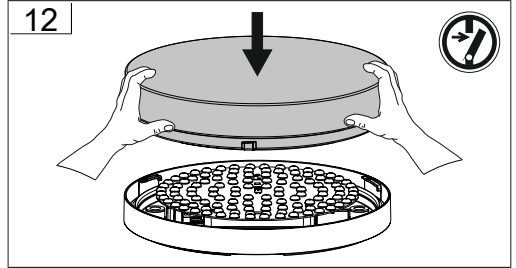
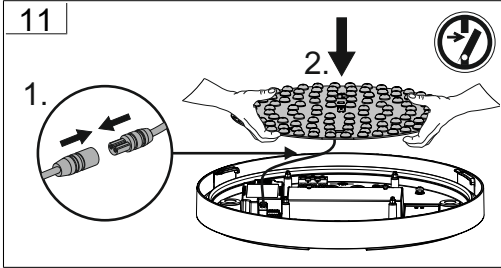

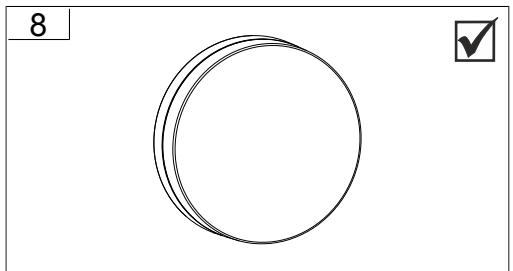
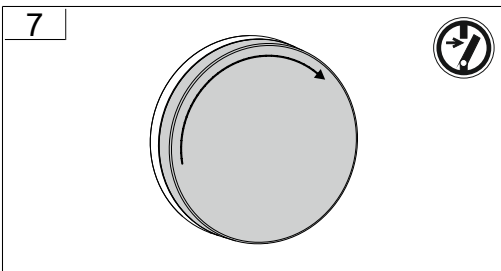
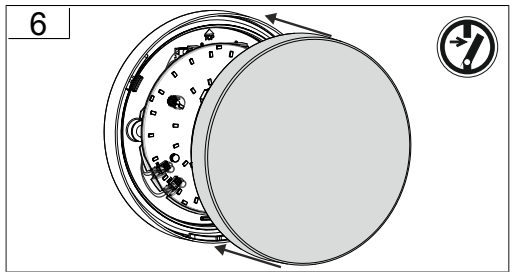
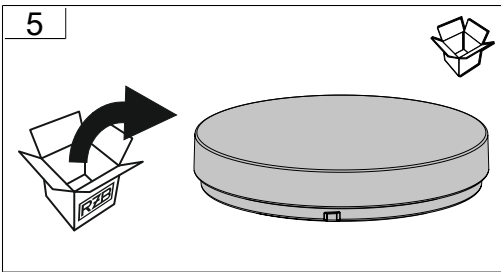
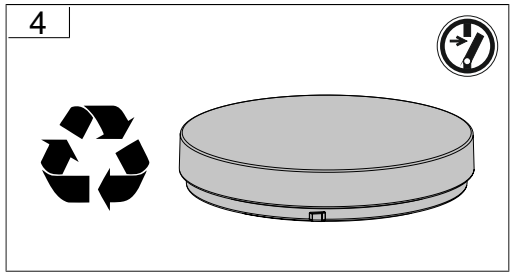
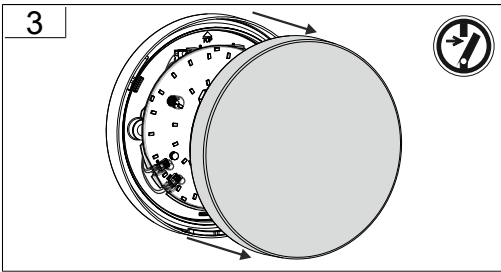
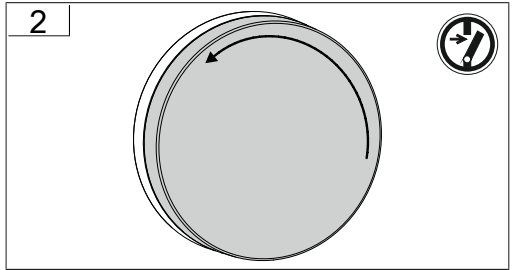
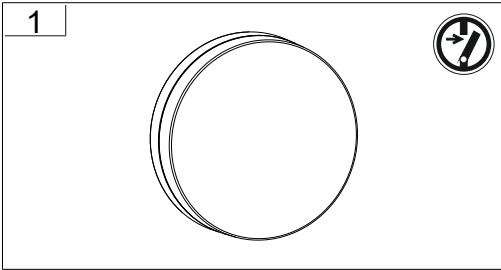

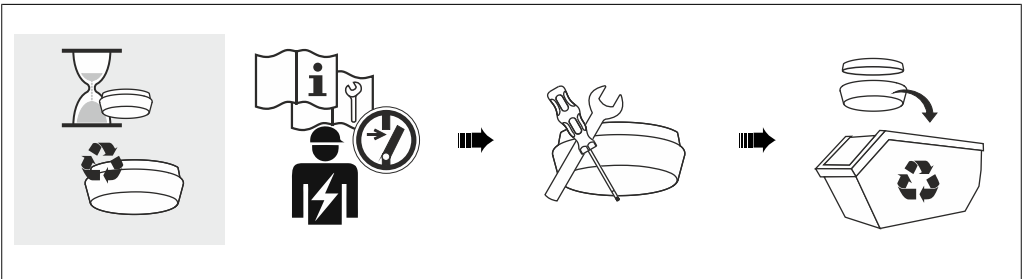
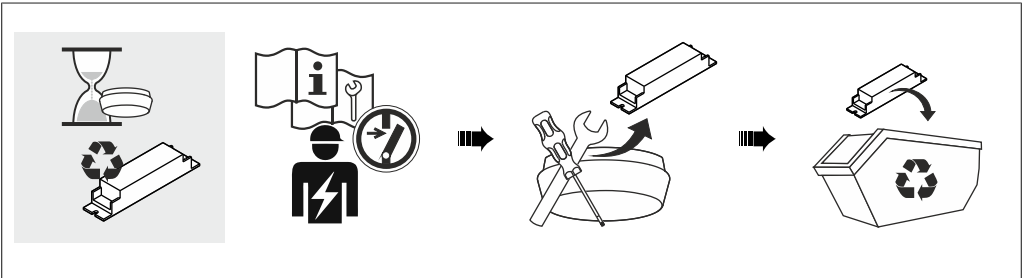
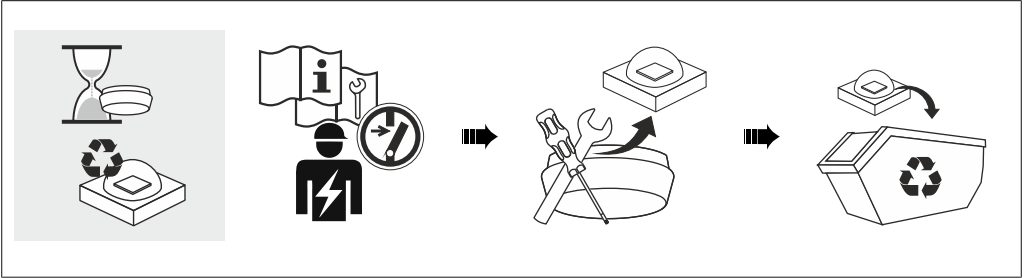





RZB - Rudolf Zimmermann, Bamberg GmbH

🏠 Rheinstraße 16, 96052 Bamberg

☎ 0951/7909-0

📠 0951/7909-198

🌐 info@rzb-leuchten.de