

# INSTRUCTION

Flat Slim Square  
312544.004.730

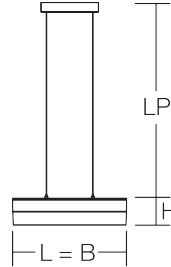

~ 220 - 240 V 50/60 Hz IP 40 IK07

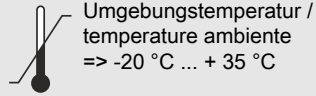

L 430, B 430, H 72



LP 500-1200



10,752  
kg



LED



3050



27



1 x 35 W

CCT [K]

3000

CRI

80

RG

RG 1

EEK

D

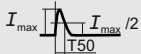

21 A / 230 μs



12



20



21



34

COS φ

0,99

$f_{min} - f_{max}$   
[MHz]

2400 - 2483

$p_{EIRP}$  [mW]

2,51

$p_{EIRP}$  [dBm]

4

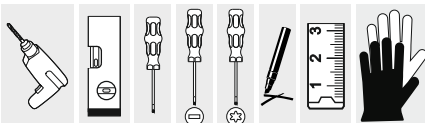



Installation erfordert  
Elektro-Fachkraft!

Symbole nach ISO 7010



### Allgemeine Sicherheitshinweise

- Der elektrische Anschluss muss ordnungsgemäß nach geltenden Normen und den nationalen sowie internationalen Sicherheits- und Unfallverhütungsvorschriften erfolgen.
- Beschädigte Leuchten dürfen nicht betrieben werden.
- Keine Haftung für Schäden durch unsachgemäßen Einsatz.
- Bei Instandsetzung nur Originalteile verwenden.
- Tragfähigkeit der Decke und Befestigungselemente sicherstellen.

### Betrieb der Leuchte

- Die unzulässigen Umgebungstemperaturen reduzieren die Lebensdauer der Leuchte, im Extremfall droht der Frühausfall.
- Zur Vermeidung von EMV-Problemen die Durchgangsverdrahtung nicht entlang der Leuchtenverdrahtung führen.
- Steuereingänge von dimmbaren Leuchten mit handelsüblichen für Netzspannung geeigneten Leitungen anschließen.

### Manipulationen unserer Produkte sind unzulässig

Veränderung, Umarbeitung, Umkennzeichnung von Produkten sowie deren Verpackung sind unzulässig und verletzen u.a. unsere eingetragenen Warenzeichenrechte. Solche Modifikationen können technische Eigenschaften unserer Produkte negativ beeinflussen, diese zerstören und möglicherweise Folgeschäden an anderen Objekten verursachen. Für durch derartige Modifikationen verursachte Schäden kann der Hersteller in keinem Fall verantwortlich gemacht werden.



Installation requires  
a qualified electrician!

Symbols according  
to ISO 7010



### General Safety Information

- Electric connection must be appropriate according to all applicable standards and other national and international safety and accident prevention regulations.
- Damaged luminaires must not be operated.
- No liability is accepted for damages resulting from improper use.
- Use genuine parts only for repair.
- Ensure stability of the ceiling and fastening elements.

### Operation of the luminaire

- Exceeding the permissible ambient temperature will reduce the luminaire's lifecycle, resulting in premature failure in extreme cases.
- Avoid ESD problems by not routing feed-through wiring directly along the wiring of the luminaire.
- Connect control inputs of dimmable luminaires with standard cables suitable for power supply voltage.

### Manipulation of our products is not permitted

Modifications, reworking, re-labelling of products as well as their package is not permitted and infringes, amongst others, our registered trademark rights. Such modifications may affect technical properties of our products, damage them and possibly cause consequential damage to other objects. The manufacturer shall not be responsible under any circumstances for damage caused by such modifications.



Bei Fragen zu unseren Symbolen, besuchen Sie folgende Webseite:

If you have any questions about our signs, visit the following website:



[https://www.rzb.de/fileadmin/assets/downloads/PDF/RZB\\_Symbolklaerung.pdf](https://www.rzb.de/fileadmin/assets/downloads/PDF/RZB_Symbolklaerung.pdf)

EEK 

Dieses Produkt enthält eine Lichtquelle der Energieeffizienzklasse D entsprechend Verordnung (EU) 2019/2015

This product contains a light source of energy efficiency class D according to regulation (EU) No 2019/2015



Jede zersprungene Schutzabdeckung ist zu ersetzen. DIN EN 60598



Replace any cracked protective shield. IEC DIN EN 60598

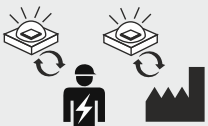

Die Lichtquelle dieser Leuchte darf nur vom Hersteller oder einem von ihm beauftragten Servicetechniker oder einer vergleichbar qualifizierten Person ersetzt werden. DIN EN 60598-1 / IEC 60598-1

The light source contained in this luminaire shall only be replaced by the manufacturer or his service agent or a similar qualified person. DIN EN 60598-1 / IEC 60598-1

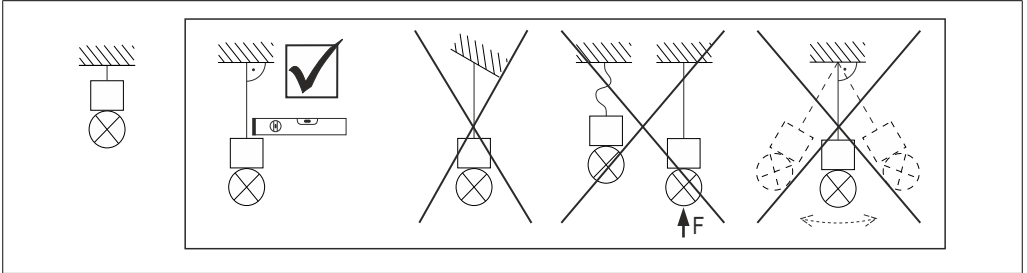



a

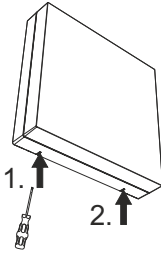

öffnen  
to open

b

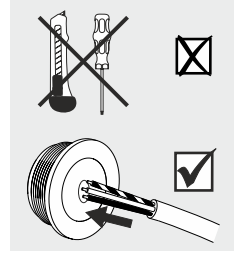

c

Dieser Bereich darf eingestellt  
werden! Konvertereinstellungen:  
This range may be set!  
Converter settings:

lout	
600 mA	
650 mA	3050lm, 3000K
700 mA	3250lm, 4000K
750 mA	
800 mA	
850 mA	
900 mA	4300lm, 3000K
950 mA	4600lm, 4000K
1000 mA	
1050 mA	
1100 mA	
1150 mA	
1200 mA	
1250 mA	
1300 mA	
1350 mA	
1400 mA	

## Reichweite Range

Funk-Sender / Empfänger  
transmitter / receiver

Betriebsfrequenzen: 2,4 ... 2,483 GHz  
Operating Conditions:

Max. Ausgangsleistung: + 4 dBm  
Max. Output power:

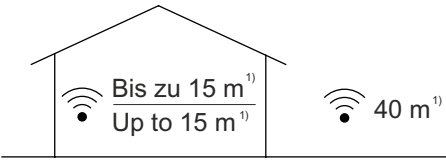

<sup>1)</sup>Die Reichweite ist stark von den umliegenden Hindernissen wie Wänden und den Baumaterialien abhängig.

Range is highly dependant on the surrounding and obstacles such as walls and building materials.

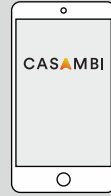

Kompatible Geräte:

Compatible devices:

- ✓ iPhone 4S oder später  
or later
- ✓ iPod 3 oder später  
or later
- ✓ iPod Touch 5th Gen. oder später  
or later
- ✓ Android 4.4 oder später produziert als  
KitKat 2013 mit kompletter Blue-  
tooth 4.0 Unterstützung  
or later devices produced  
after 2013 with full BT 4.0  
support

Mit Casambi Mesh Network Technologie agiert jede Steuereinheit auch als ein Repeater. Durch den Einsatz mehrerer Casambi Units können größere Reichweiten erreicht werden.

Casambi uses mesh network technology so each CBU-ASD acts also as a repeater. Longer ranges can be achieved by using multiple Casambi units.



Die Reichweite des Funksignals hängt von der Umgebung ab, z.B. Leuchte, Möbel, Menschen oder der Gebäudekonstruktion. Sie muss in der Installation geprüft und abgenommen werden.

The range of the radio signal depends on the environment, e.g. on luminaire, building construction, furniture or people. It must be testes and approved in the installation.



Um eine gute Funkverbindung zu gewährleisten, darf die Steuereinheit nicht komplett mit Metall verdeckt werden!

To ensure a good radio connection, the control unit must not be completely covered with metal!



## Erstmalige Anwendung



Die Casambi App ist leicht zu installieren. Folgen Sie einfach diesen Schritten:

### First time use

Casambi app is easy to use. Follow these simple steps:

1. Casambi- App aus dem Apple App Store oder Google Play Store downloaden.  
Download the app from Apple App Store or Google Play Store.
2. Smart + free- Steuereinheit betriebene Leuchte einschalten  
Switch on your Casambi enabled luminaires.
3. App öffnen.  
Open the app.
4. Die App findet automatisch die Leuchten, die eingeschaltet sind  
Casambi app will automatically find all Casambi enabled luminaires that are switched on.
5. Klicken Sie auf „Alle Leuchten in Benutzung nehmen“.  
Click on „Take all lamps into use“.
6. Die Leuchten werden automatisch zu einem Netzwerk hinzugefügt.  
Casambi app will automatically add all found luminaires to one network and open the „Lamps“ tab.
7. Vergeben Sie eine von vier Freigabeoptionen für ihr Netzwerk (siehe Seite „Netzwerke und Freigabe“)  
Assign one of four sharing options for your network (see page „Network setup and sharing“).

## Zusatzinfo

### Additional info



Link zum iOS  
Link to iOS



Link zum Android  
Link to Android



Link zur weiteren Information



Link to more information



## EU-Konformitätserklärung / EU Declaration of Conformity

**CASAMBI**

## EC Declaration of Conformity

We, the manufacturer

Name: **Casambi Technologies Oy**  
 Address: Bertel Jungin aukio 1 E  
 02600 Espoo, Finland  
 Telephone: +358 10 501 2950

declare under our sole responsibility that the following product

Brand name: Casambi  
 Model: CBU-A2D  
 Description: Bluetooth 4.0 2ch 0-10V controller

is in conformity with the provisions of Council Directives

Radio Equipment Directive 2014/53/EU  
 Restriction of Hazardous Substances (RoHS) 2011/65/EC and  
 Regulation (EC) No 1907/2006 of the European Parliament and of the Council (REACH).

The following harmonised standards and technical specifications have been applied:

Health and Safety (Article 3.1a): **IEC 61347-2-11:2001, AMD1:2017**  
**IEC 61347-1:2015, AMD1:2017**

Electromagnetic Compatibility (Article 3.1b): **ETSI EN 301 489-1 v2.1.1**  
**ETSI EN 301 489-17 v3.1.1**

Radio Spectrum Efficiency (Article 3.2): **ETSI EN 300 328 v.2.1.1**

The last two digits of the year in which the CE marking was affixed: 19

To meet the requirements of these directives the device must be used in accordance with the manufacturer's instructions.

Espoo, 30<sup>th</sup> of September, 2019

Casambi Technologies Oy

Kai Tötterman,  
 Director of Hardware Design

Casambi Technologies Oy  
 Bertel Jungin aukio 1 E  
 02600 Espoo, Finland

www.casambi.com  
 info@casambi.com  
 tel. +358 10 501 2950



**EG-Konformitätserklärung**  
**EC-Declaration of Conformity**  
**Déclaration UE de conformité**  
**Declaración de conformidad CE**  
**Deklaracja zgodności UE**



**Hersteller, Anschrift:**  
**Manufacturer, address:**  
**Fabricant, adresse:**  
**Fabricante, dirección:**  
**Producent, adres:**

**RZB Rudolf Zimmermann, Bamberg GmbH**  
**Rheinstrasse 16**  
**96052 Bamberg**  
**Deutschland / Germany / Allemagne / Alemania / Niemcy**

Wir erklären in alleiniger Verantwortung, dass das Produkt  
*We declare under sole responsibility that the product*  
*Nous déclarons, sous notre propre responsabilité, que le produit*  
*Declaramos bajo nuestra sola responsabilidad que el producto*  
*Deklarujemy z pełną odpowiedzialnością, że produkt*

**Produktbezeichnung:**  
**Product designation:** **Flat Slim Square**  
**Description des produits:**  
**Designación de producto:** **312544.004.730**  
**Oznaczenie produktu:**

mit den folgenden EG-Richtlinien und Normen übereinstimmt:  
*complies with the following EC Directives and standards:*  
*est conforme aux normes et directives de l'UE suivantes:*  
*cumple con las siguientes directivas y normas CE:*  
*jest zgodny z następującymi dyrektywami UE i normami:*

<p><b>RED Directive</b> 2014/53/EU</p>	<p><b>(3.1a)</b>  EN 50665:2017  EN 60598-1:2021/A11:2022  EN 60598-2-1:1989  EN 62471:2008  EN 62493:2010  <b>(3.1b)</b>  EN 301 489-1:V2.2.3  EN 301 489-17:V3.2.4  EN 55015:2019/A11:2020  EN 61000-3-2:2019/A1:2021  EN 61000-3-3:2013+A1:2019+A2:2021+A2:2021/AC:2022  EN 61547:2023  <b>(3.2)</b>  EN 300 328:V2.2.2</p>
<p><b>RoHS Directive</b> 2011/65/EU</p>	<p>EN 63000:2018</p>
<p><b>ErP Directive</b> 2009/125/EC</p>	<p>(EU) 2019/2020</p>

Dokument-Nr. / Document No. / Document No. **24001486**  
Document No. / Nr dokumentu

Aussteller / Issuer / Délivré par: **RZB Rudolf Zimmermann, Bamberg GmbH**  
Otorgante / Wystawca:

Ort, Datum / Place, Date / Lieu, date: **Bamberg, 02.02.2024**  
Lugar, Fecha / Miejsce, data:

Rechtsverbindliche Unterschrift:  
Legally binding signature:  
Signature juridiquement obligatore:  
Firma legalmente vinculante:  
Prawnie wiązacy podpis:

  
Reiner Jürgens  
CEO/Direktor Zarządzający/Geschäftsführer



1

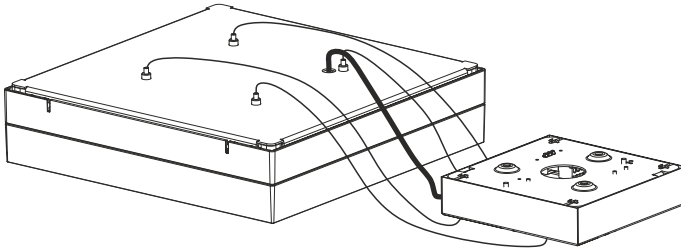

2

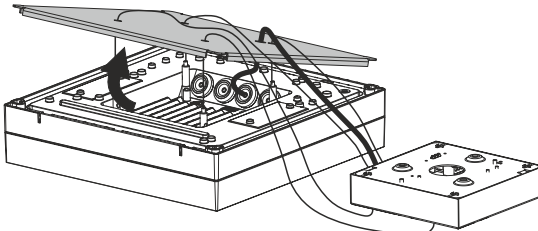

3

drücken  
push

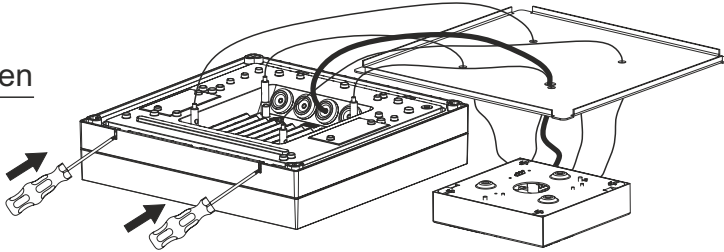

4

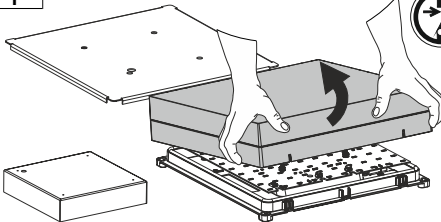

5

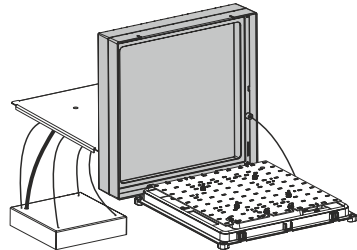

6

Stecker entfernen!  
Remove plug!

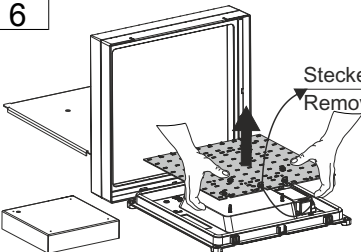

7

Konverter einstellen  
siehe Info  
Set converter  
see info

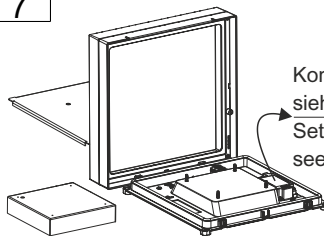

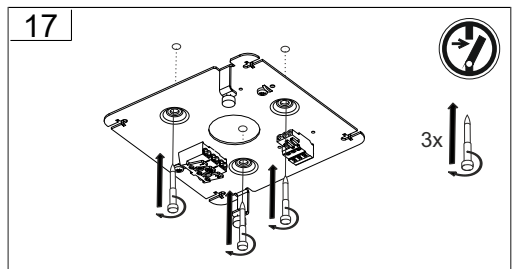
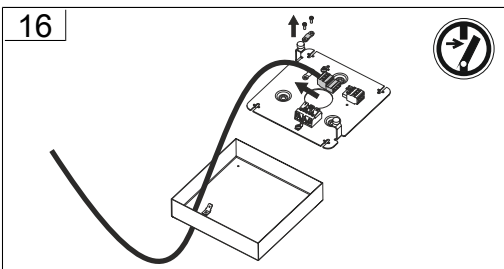
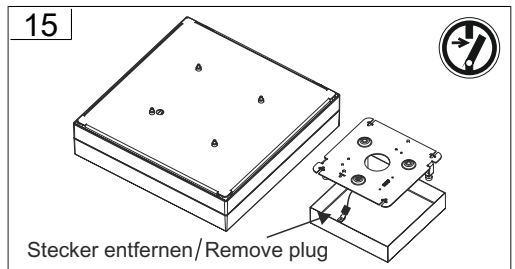
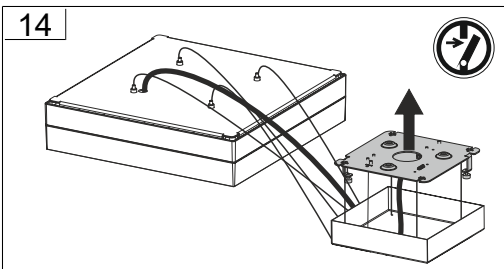
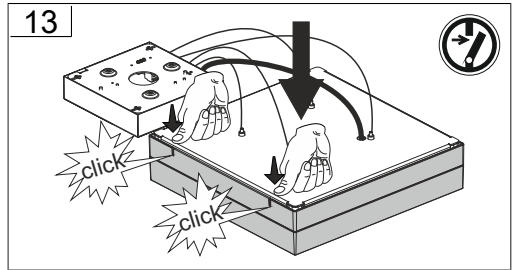
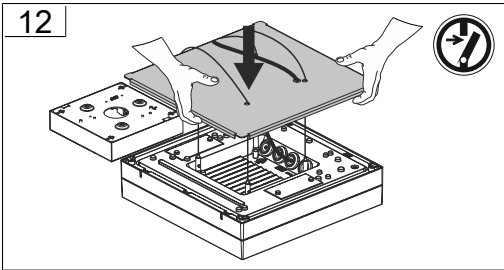
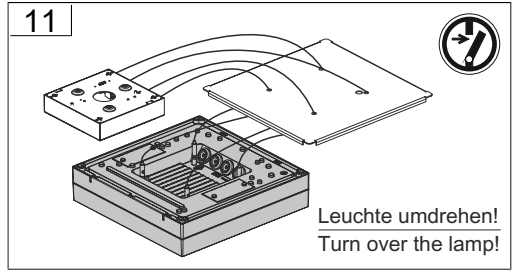
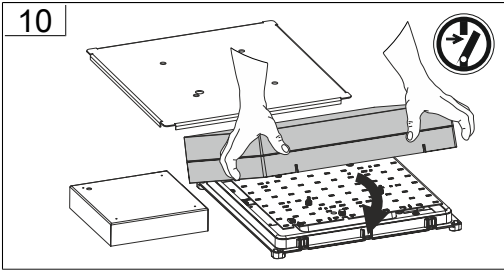
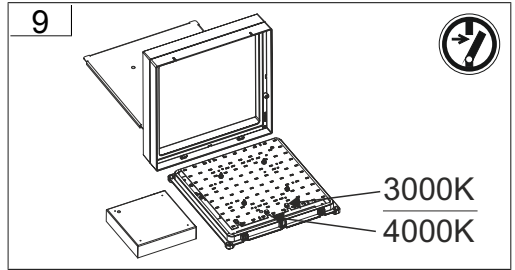
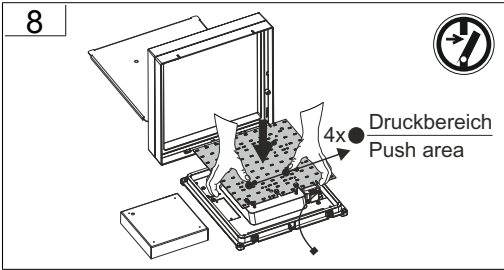



18

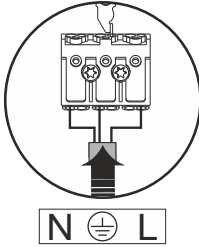

19

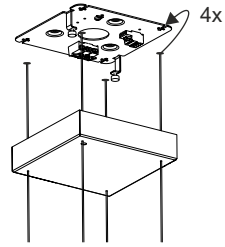

20

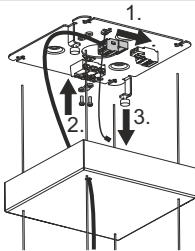

21

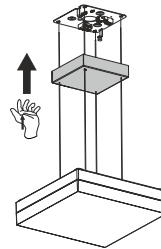

22

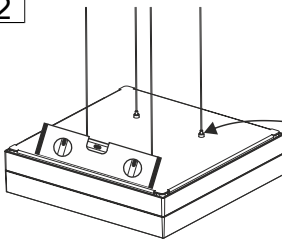

Drücken und  
Seil nachziehen!  
Press and  
Tighten the rope!

23

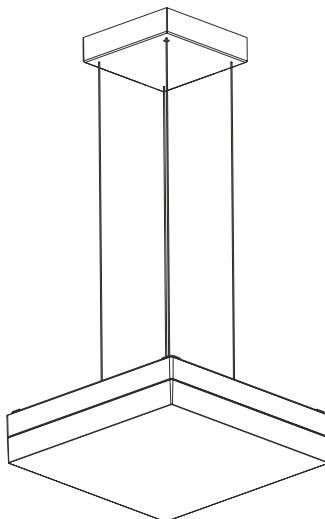

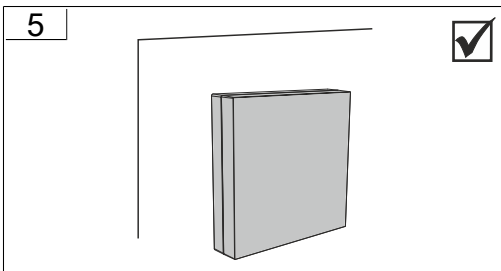
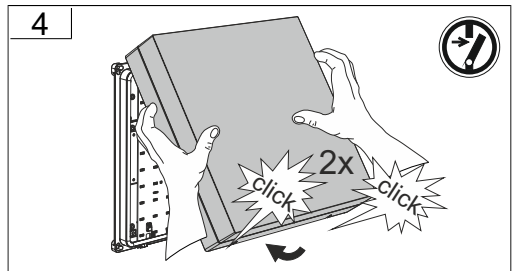
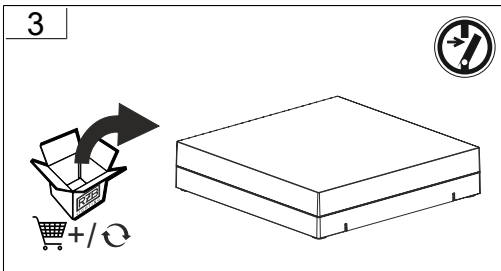
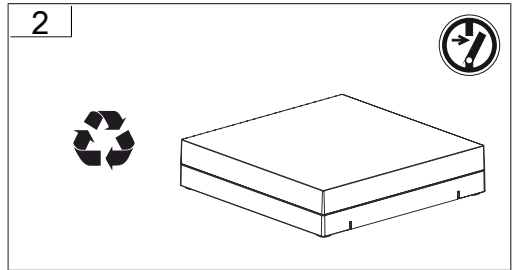
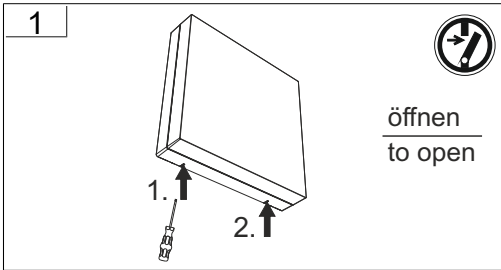

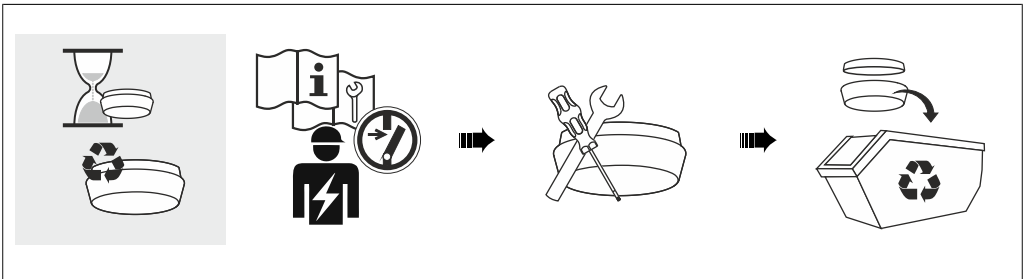
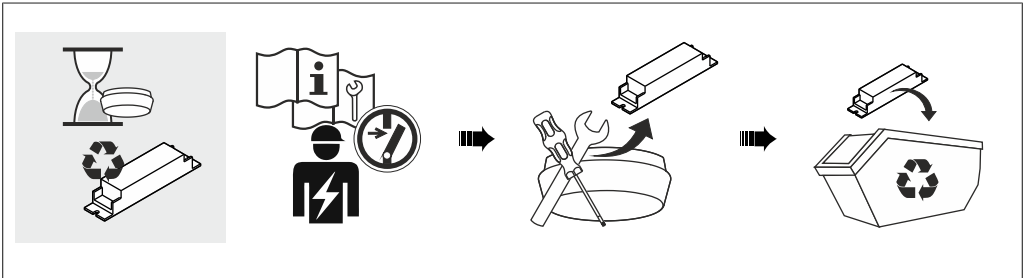
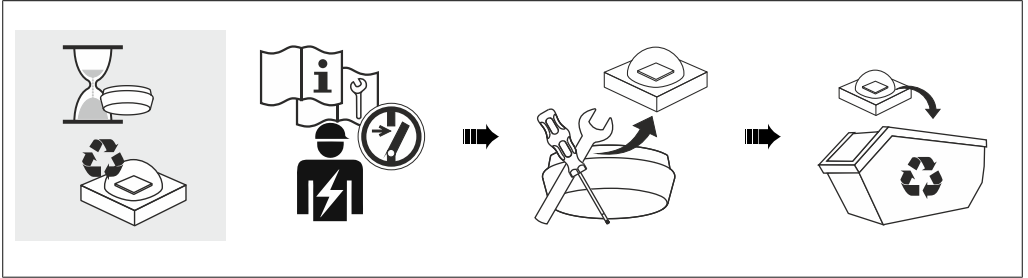



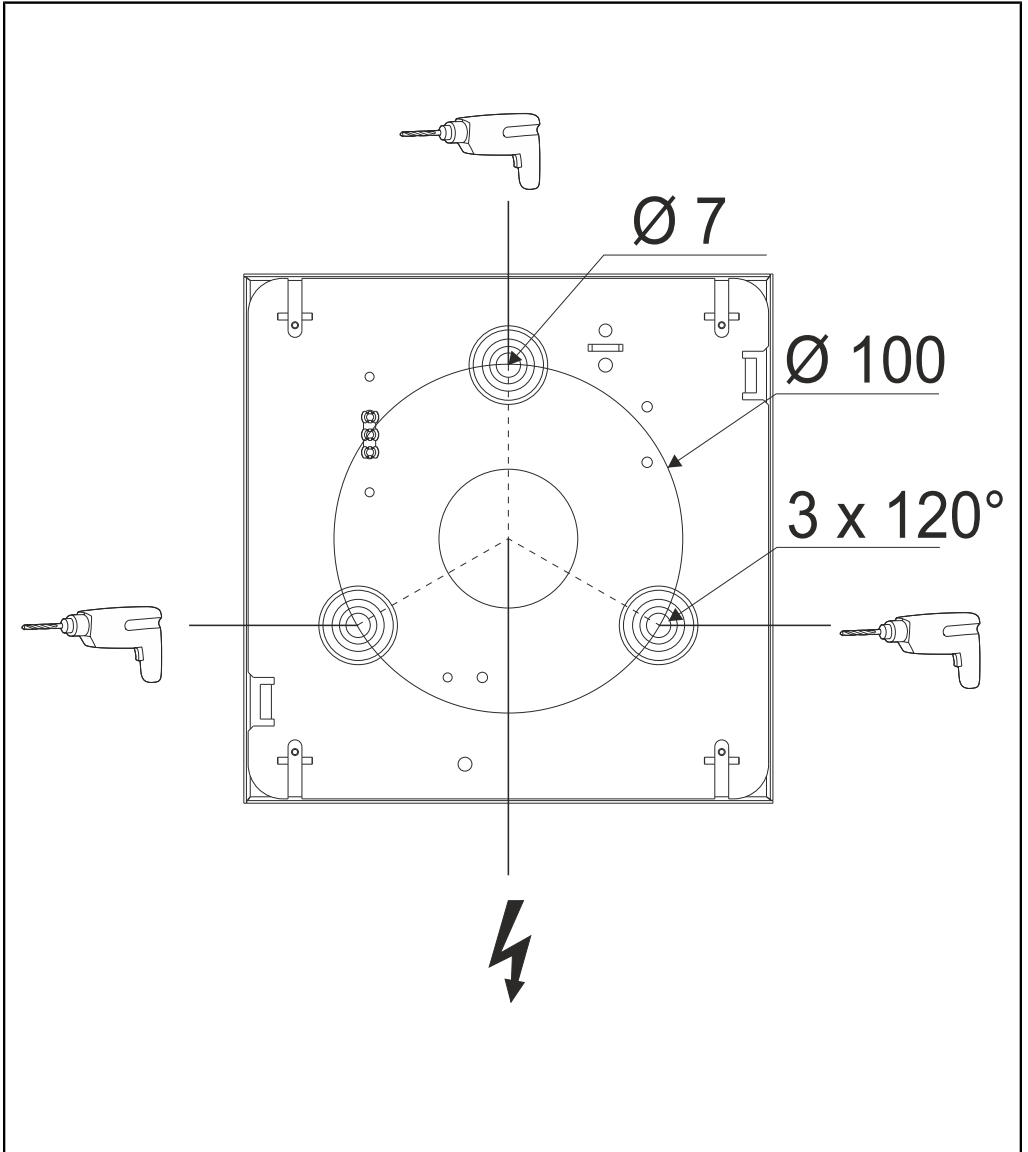

RZB - Rudolf Zimmermann, Bamberg GmbH

🏠 Rheinstraße 16, 96052 Bamberg

☎ 0951/7909-0

📠 0951/7909-198

🌐 [info@rzb-leuchten.de](mailto:info@rzb-leuchten.de)