

Brilliantly simple MultiLumen setting

# LINEDO 50

The high-speed continuous line luminaire

**Can** you  
already count to  
three?



# Simply brilliant.

Setting MultiLumen is easy as pie  
with MES - MultiLumen Easy Select.

# Brilliantly simple.



# MES - MULTILUMEN EASY SELECT

Simply brilliant. Brilliantly simple.



For LINEDO 50 with MES, the desired MultiLumen level can be easy set via the light or fuse switch. No dip switch, no riser.

A real convenience and time advantage, not just for large installations.

powered by



## It's that simple

- With three interruptions to the power supply, the luminaires enter selection mode and start the five different power levels as a continuous sequence.
- To set the desired level, simply press the switch once again. Done. The entire line is set to the selected level.



**Five adjustable light levels enable five different room uses.**

Ingenious: If different phases are used during installation, a different MultiLumen level can be set for each phase.

# **LINEDO 50 with MES - MultiLumen Easy Select**

Lighting management rethought, made simple.



## **EASY! 5 IN 1**

Different application options with just one item.  
Centrally adjustable MultiLumen function.

## **EASY! INSTALL**

With the LINEDO 50 single-component system, you buy a completed piece of continuous line: unpack, hang up, done.

## **EASY! CUSTOMISE**

Centralised control of all luminaires in the circuit as standard with on/off:  
MES - MultiLumen Easy Select for easy adjustment of the power levels.

## **EASY! STAY ON THE GROUND**

Thanks to MES - MultiLumen Easy Select, the appropriate MultiLumen level can be set centrally. You don't have to touch the luminaire for this: no riser, no effort!

## **EASY! LEAVE IT HANGING**

Production out, warehouse in - LINEDO 50 adapts ultra-fast to changes in utilisation thanks to the MES technology. And that throughout the entire life cycle of a property.

# LINEDO 50

Overview



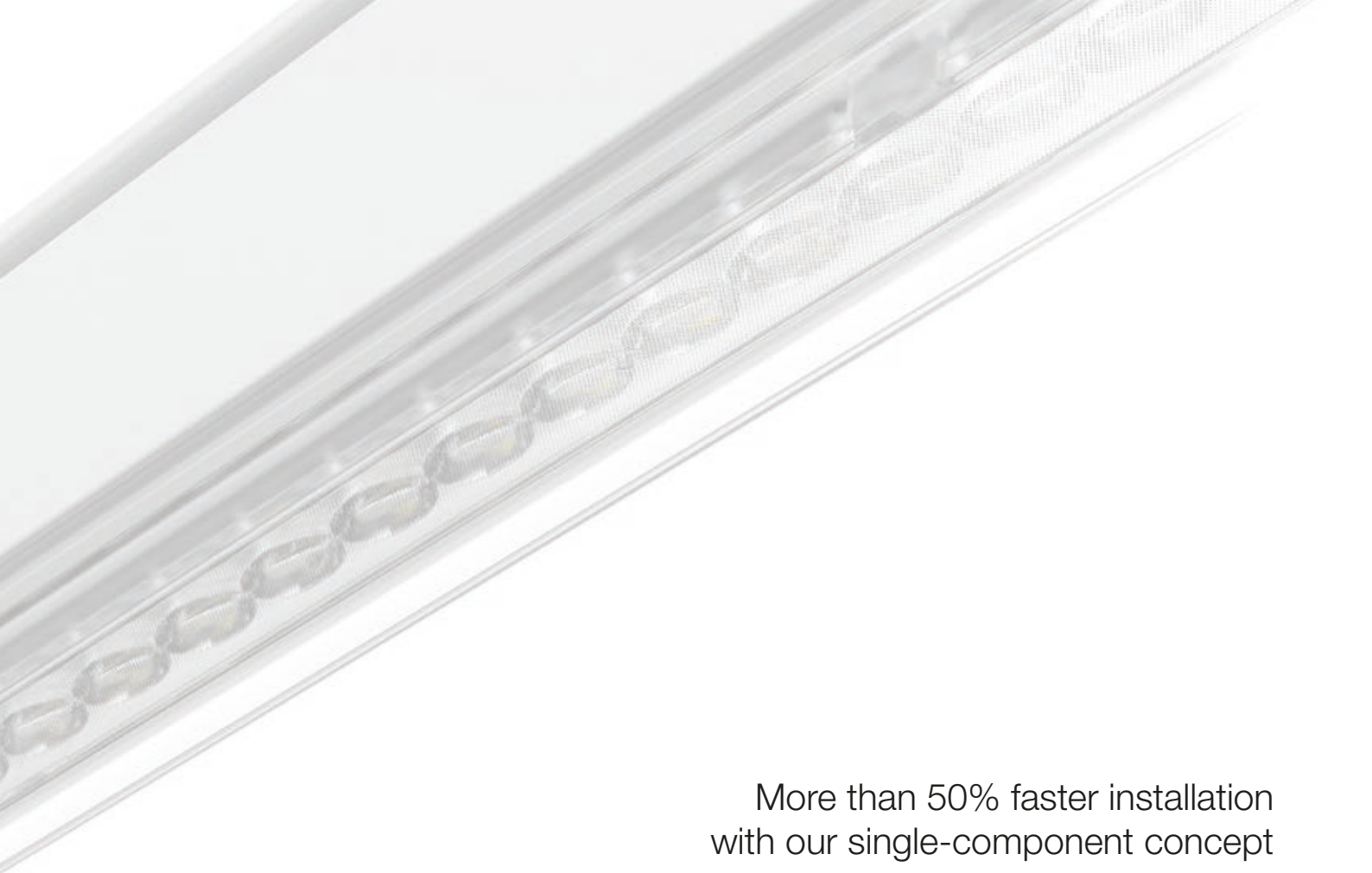

More than 50% faster installation  
with our single-component concept

## LINEDO 50

The high-speed continuous line luminaire



Continuous line luminaire  
modules optical lens

Page 24



Continuous line luminaire  
modules opal diffuser

Page 25



Sensors

Page 28-29



Emergency lighting

Page 30-31



# LINEDO 50

The high-speed continuous line luminaire

## Cutting-edge lighting technology for production and logistics

Discover our latest addition to RZB's range of continuous-line luminaire systems, tailor-made for industry and logistics. With outstanding performance and German quality standards, LINEDO 50 is not only eligible for subsidies, but also a real game changer in terms of efficiency and installation time.

Our single-component solution, made in Germany, enables effortless 1:1 replacement of your old continuous line luminaire in no time at all and with no costly refurbishment.

Preconfigured options and a practical checklist make planning a breeze.

Whether replacing luminaires or fitting new ones, LINEDO 50's single-component concept and clever accessories keep you in pole position in the installation race.

Unpack it, hang it, and you're done!

## Architecture

- ⊕ **Perfect:** Ready to install, single-component continuous line luminaire system.
- ⊕ **Clever:** Complete modules in standard lengths of 1500, 3000 and 4500 mm for quick and easy refurbishment and significant reduction of installation costs and time.
- ⊕ **Advantageous:** Up to 10 years warranty.
- ⊕ **Uniform:** For uniform illumination of large areas and directional illumination in manufacturing and logistics.

## Lighting planning

- ⊕ **Reliable planning:** 4 light distribution options and 5 performance levels cover just about any lighting requirement in industry and logistics.
- ⊕ **Ideal:** Special lens geometry for high-bay warehouse applications.
- ⊕ **Efficient:** Permanently low running costs thanks to luminous efficacy up to 190 lm/W and an LED rated life of up to 100000 h.
- ⊕ **Outstanding:** Extremely good Color over Angle (CoA). Special microstructures in the specially developed lens optics reduce the yellow corona (caused by chromatic aberration) to an absolute minimum.
- ⊕ **Matching:** Perfect for 1:1 replacement during renovations.





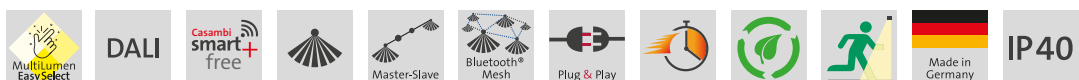







## Installation

- ⊕ **Installation-friendly:** Ultra-rapid installation thanks to Plug & Play modules.
- ⊕ **MES - MultiLumen Easy Select:** MultiLumen levels of the on/off variants can be easily adjusted via the light switch - for the entire circuit.
- ⊕ **Convenient:** Plug-in system for phase selection from outside.
- ⊕ **Optimised:** Sliding mounting brackets. Ideal for luminaire replacement.
- ⊕ **Sustainable:** Optimised cardboard packaging saves time during unpacking and disposal.



# LINEDO 50

## Overview

1 Components	
3 Standard lengths	<b>1500 mm</b> <b>3000 mm</b> <b>4500 mm</b>
1 Protection type	<b>IP 40</b>
1 Colours	 <b>RAL 9016</b>
2 Type of mounting	 
2 Optical systems	 
4 Light distribution options	   
5 Output levels	<b>14.400</b> <b>18.000</b> <b>22.500</b> <b>27.000</b> <b>36.000</b>
1 Colour temperature	<b>840</b> <b>additional options</b>
3 Lighting controls	 <b>DALI</b> 
2 Through-wirings	<b>5 pole</b> <b>7 pole</b>

# LINEDO 50

The revolution continues

With LINEDO 50 continuous line luminaire modules – an energy-efficient and cost-effective lighting solution for manufacturing and logistics, with simple planning and tool-free high-speed installation.



# LINEDO 50

Profile and optics



Socket with contact openings

Connector system:  
Safe, reliable, fast.

Built-in plug  
with contact pins



Non-yellowing PMMA optical lens systems  
with 3 practical light distributions:  
32°/74° High Rack, 60° and 90°

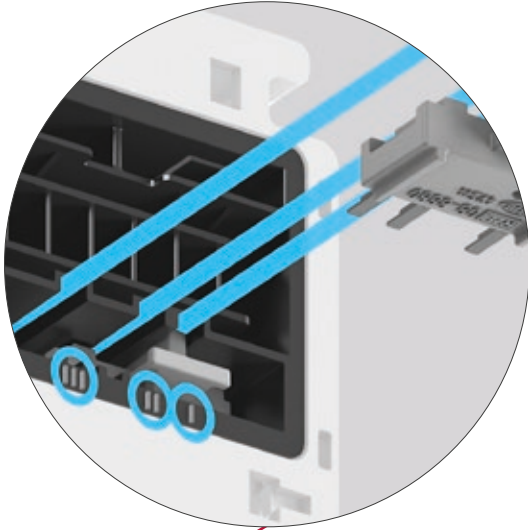

Convenient phase selection from outside via jumper.

Groove integrated in the profile as for mounting clips, cable holders and adapters for emergency lights.

Diffuser made of opal non-yellowing plastic (PMMA) for applications with diffuse light distributions.

Profiled steel plate, electrolytically galvanised and coated white:  
Durable and easy to clean.

Accurate to the millimeter:  
Our continuous line luminaire and blank module comes in these lengths:  
1500 mm  
3000 mm  
4500 mm



Environmentally friendly and resource-saving due to replaceable and recyclable components.

# LINEDO 50

## Profile and optics

The innovative combination of two LEDs under one lens has created the ideal ratio of efficiency and performance. Special microstructures in the specially developed lens optics reduce the yellow corona (caused by chromatic aberration) to an absolute minimum.



32°/74° High Rack narrow

**N1**

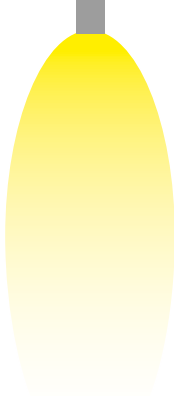

60° medium

**M1**

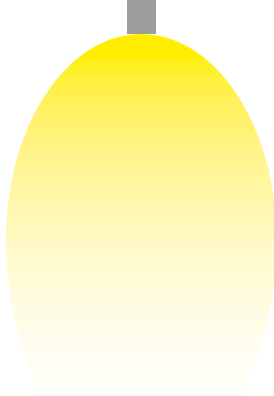

90° wide

**W1**



High opal diffuser for wide uniform light distribution with increased proportion of indirect light.

≤ 22  
R<sub>UG</sub> ✓

≤ 25  
R<sub>UG</sub> ✓

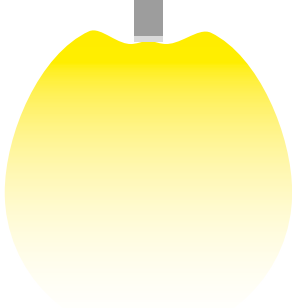

opal  
diffuse  
OH



Optic/ Beam angle in °	Luminous flux in lm/unit (1500 mm)	R <sub>UG</sub> (4H8H)
<b>wide</b>		
90	4800	21,8
90	6000	22,6
90	7500	23,4
90	9000	24,0
90	12000	25,0
<b>medium</b>		
60	4800	18,5
60	6000	19,3
60	7500	20,0
60	9000	20,7
60	12000	21,7
<b>narrow - High Rack</b>		
32/74	4800	20,9
32/74	6000	21,7
32/74	7500	22,5
32/74	9000	23,1
32/74	12000	24,1
<b>opal diffuse</b>		
-	4300	24,8
-	5400	25,6
-	6800	26,4
-	8100	27,0
-	10800	28,0

All values with extremely good Color over Angle (CoA). Special microstructures in the specially developed lens optics reduce the yellow corona (caused by chromatic aberration) to an absolute minimum.



The mounting clips for suspension and ceiling mounting clip onto the profile from the outside. Easy to slide when load-free, firmly clamped when under load.

Suspension kits for chain suspension

Each LINEDO 50 module has a LINEDO 50 plug at one end and the corresponding socket at the other end. Suitable end caps are available for a clean finish at the end of the continuous line luminaire.



## One third of the distance with the manlift!

### LINEDO 50

1. Start from working platform: Set the fixing points
2. Move on: Mount the LINEDO 50 modules, connect them and turn on the power

### Conventional continuous line luminaire systems

1. Start from working platform: Set the fixing points
2. Move on: Hook up the mounting rails, connect
3. Continue: Insert luminaire modules and seals if necessary, turn on the power ...



Cable holder for routing additional connection and control cables – for example for emergency lighting.

# LINEDO 50

Attachment system

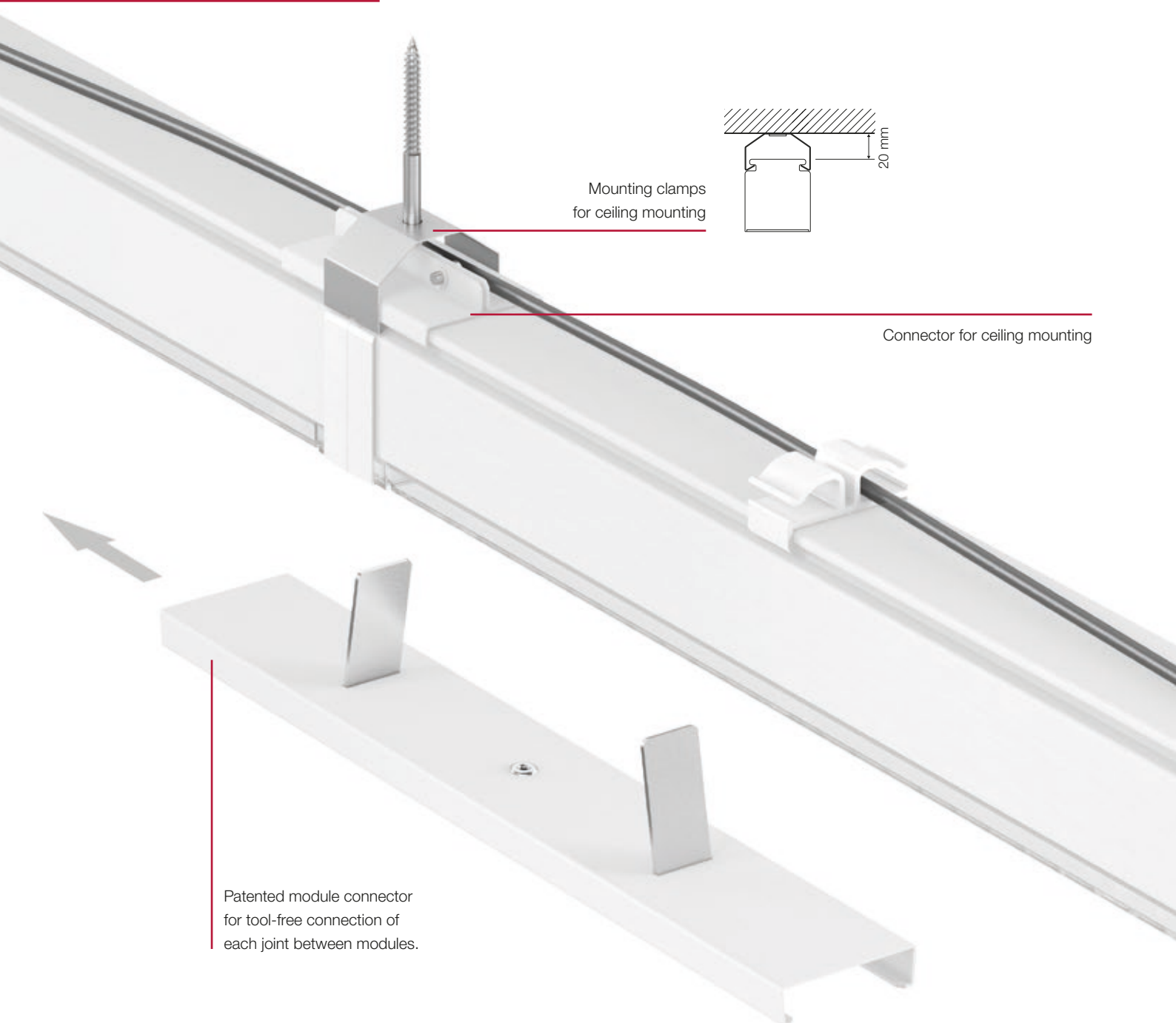

Mounting clamps for ceiling mounting

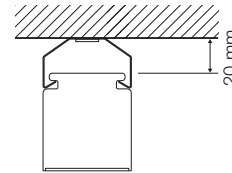

Connector for ceiling mounting

Patented module connector for tool-free connection of each joint between modules.

## Attachment points required for suspension

Maximum every 4.5 m or at every joint between continuous line luminaire modules



LINEDO 50 modules can generally be installed according to the above diagram.

For increased planning reliability and for ceiling mounting in general, we recommend two attachment points per module.

For series connection of shorter units, increase the number of attachments as required.

# LINEDO 50

Sensor modules and emergency lighting



CENTRYXX IP40 luminaires for **escape route illumination** can be positioned anywhere along the LINEDO 50 profile using the appropriate adapter. The connection and control cable for the emergency lighting is fed in at the top of the profile.



GSUN 5 S luminaires for **escape route identification** can be positioned anywhere along the LINEDO 50 profile using the appropriate adapter. The connection and control cable for the emergency lighting is fed in at the top of the profile.



## MULTIDIGIT air:

Wireless monitoring system for self-contained emergency luminaires with Bluetooth® control for wireless networking.



Two separate cable screw fittings

Middle power feed

Live end power feed

The modules for sensors built to the **Zhaga standard** can be equipped with suitable sensor variants as required.



**Bluetooth® networking capability:**  
Control within the LINEDO 50 continuous line luminaire via DALI, communication between separate continuous lines via Bluetooth® Mesh.

# LINEDO 50

My strengths in detail

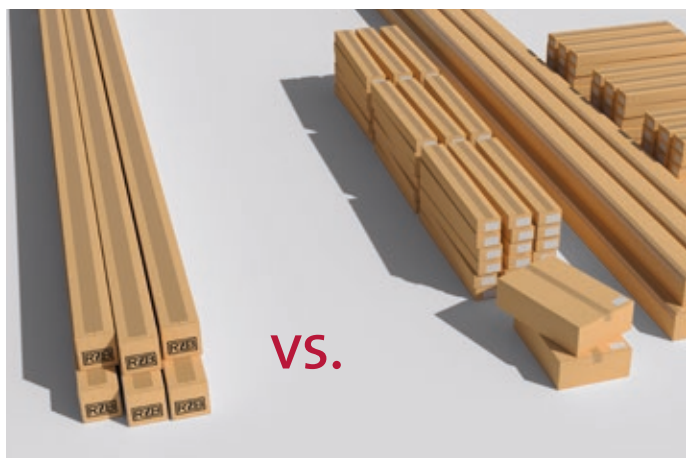

## + Ready-made unit

Tired of dealing with mounting track plus LED insert plus connector plus end cap plus chaos on the construction site? Put an end to all that time-consuming fiddling about.

LINEDO 50 is a ready-made continuous line luminaire: unpack it, hang it and get on with your life.

Viva la revolución!



## + Setting a shining example

Less waste, less time: our clever cardboard tube packaging is frustration-free and easy to recycle.

One unit = one packaging!



## + Tool-free mounting

LINEDO 50 is performance-designed. And that goes for installation too. It's faster than any other continuous line luminaire system.

No installation tools required. Simply plug together the ready-made modules, clip on the suspensions and you're done.



32°/74° High Rack  
narrow beam

60°  
medium beam

90°  
wide beam

opal  
diffuser

## Photometrics

- ⊕ Luminous efficiency up to 190 lm/W.
- ⊕ Luminaire flux up to 12000 lm/1.5 m.
- ⊕ Colour temperature 4000 K.
- ⊕ Colour rendering index CRI > 80.
- ⊕ LED rated life up to 100000 h (L80).
- ⊕ Colour consistency within 3-steps MacAdam (3 SDCM).
- ⊕ Extremely good colour over angle (CoA). Minimal yellow corona.
- ⊕ Special High Rack optical lens system for efficient lighting in high-bay aisles.
- ⊕ MES - MultiLumen Easy Select: MultiLumen levels of the on/off variants can be easily adjusted via the light switch - for the entire circuit.

# LINEDO 50

Variants numbers at a glance

## Find your number

We don't want to bombard you with reference numbers. Nevertheless, we have to find a way to codify our multitude of variations.

So let's do this differently! Just tell us what you want: Simply replace the digits of the example number given below, with the codes of your choice.

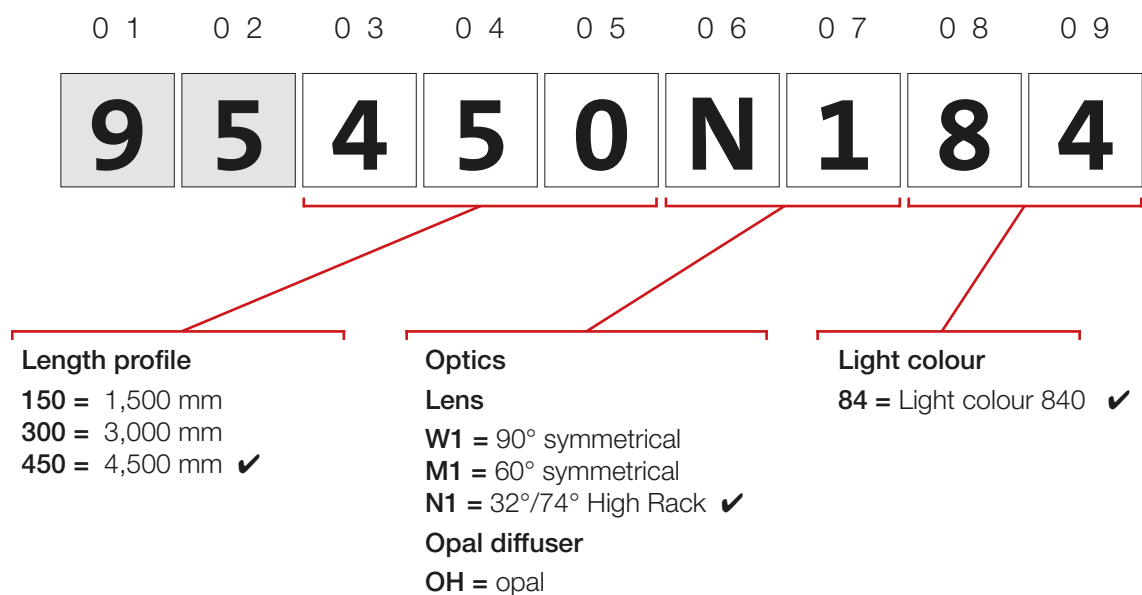



1 0    1 1    1 2    1 3    1 4    1 5    1 6    1 7    1 8

**2** . **7 7 6** . **4 0 2**

**Profile colour**  
2 = white ✓

**Number of poles**  
5 = 5-pole  
7 = 7-pole ✓

**Lighting control**  
00 = on/off  
76 = DALI ✓

**Module arrangement**  
0 = continuous LED  
4 = 33% blank module ✓  
5 = 50% blank module  
6 = 67% blank module 1  
7 = 67% blank module 2  
9 = 100% blank module

**Output levels [lm/1.5 m]**  
**MES on/off**  
0M = 4,800  
6,000  
7,500  
9,000  
12,000  
**DALI**  
00 = 6,000  
01 = 9,000  
02 = 12,000 ✓

# LINEDO 50

## Product overview | Continuous line luminaire module with lens optics

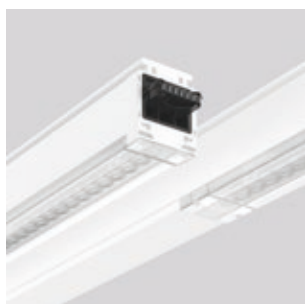

### Coding key

#### A – Optic / Lens

N1 = 32°/74° High Rack  
M1 = 60° symmetrical  
W1 = 90° symmetrical

#### E - Power levels DALI

O0 = 6.000 lm / 1.500 mm  
O1 = 9.000 lm / 1.500 mm  
O2 = 12.000 lm / 1.500 mm

#### M - Power levels MES on/off

4.800 lm / 1.500 mm  
6.000 lm / 1.500 mm  
7.500 lm / 1.500 mm  
9.000 lm / 1.500 mm  
12.000 lm / 1.500 mm



### Continuous line luminaire | LINEDO 50 – optical lens system

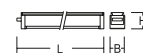

Type of protection: IP 40  
Protection class: I  
Impact resistance: IK03  
Operating range: -20°C to +50°C

Rapid-installation complete module for universal use as a continuous line luminaire. System profile made of profiled steel plate, coated. High-efficiency LED units with optimum light control thanks to clear plastic (PMMA) lens optics. White plastic cover for blank units

Simple, tool-free installation of system profiles using separate accessories for cable, chain or ceiling suspension. Tool-free connection and mechanical connectors to secure. Easy selection of phase settings from outside thanks to patented system

**Please order supply module, connection and installation accessories separately.**

**MES - MultiLumen Easy Select:** Luminous flux can be easily, quickly and centrally adjusted for the entire continuous line in 5 steps through voltage interruption. Factory setting is the highest luminous flux.

Available colour: white

Reference number	Dimensions [mm]	Optic	Light colour	Number of poles	Lighting control	Module arrangement	Output levels	Price category
<b>Continuous line luminaire modules with optical lens system</b>								
<b>Module 1500</b>								
<b>① 100% light</b>								
95150A842.500.00M	L 1516, B 53, H 59	A	840	5	on/off	100% light	MES	21
95150A842.776.0E	L 1516, B 53, H 59	A	840	7	DALI	100% light	E	21
<b>Module 3000</b>								
<b>① 100% light</b>								
95300A842.500.00M	L 3016, B 53, H 59	A	840	5	on/off	100% light	MES	21
95300A842.776.0E	L 3016, B 53, H 59	A	840	7	DALI	100% light	E	21
<b>⑤ 50% light – 50% blank, light/blank arrangement</b>								
95300A842.500.50M	L 3016, B 53, H 59	A	840	5	on/off	50% blank	MES	21
95300A842.776.5E	L 3016, B 53, H 59	A	840	7	DALI	50% blank	E	21
<b>Module 4500</b>								
<b>① 100% light</b>								
95450A842.500.00M	L 4516, B 53, H 59	A	840	5	on/off	100% light	MES	21
95450A842.776.0E	L 4516, B 53, H 59	A	840	7	DALI	100% light	E	21
<b>④ 67% light – 33% blank, light/blank/light arrangement</b>								
95450A842.500.40M	L 4516, B 53, H 59	A	840	5	on/off	33% blank	MES	21
95450A842.776.4E	L 4516, B 53, H 59	A	840	7	DALI	33% blank	E	21
<b>⑥ 33% light – 67% blank, blank/light/blank arrangement</b>								
95450A842.500.60M	L 4516, B 53, H 59	A	840	5	on/off	67% blank	MES	21
95450A842.776.6E	L 4516, B 53, H 59	A	840	7	DALI	67% blank	E	21
<b>⑦ 33% light – 67% blank, light/blank/blank arrangement</b>								
95450A842.500.70M	L 4516, B 53, H 59	A	840	5	on/off	67% blank	MES	21
95450A842.776.7E	L 4516, B 53, H 59	A	840	7	DALI	67% blank	E	21

### Continuous line luminaire | LINEDO 50 – blank modules

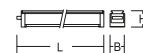

Type of protection: IP 40  
Protection class: I  
Impact resistance: IK03  
Operating range: -20°C to +50°C

Rapid-installation complete module for universal use as a continuous line luminaire. System profile made of white coated profiled steel plate. Cover: plastic, white.

Simple, tool-free installation of system profiles using separate accessories for cable, chain or ceiling suspension. Tool-free connection and mechanical connectors to secure. Easy selection of phase settings from outside thanks to patented system

**Please order supply module, connection and installation accessories separately.**

Available colour: white

Reference number	Dimensions [mm]	Number of poles	Module arrangement	Price category
<b>Blank modules</b>				
<b>⑨ 100% blank</b>				
<b>Module 1500</b>				
9515000002.500.900	L 1516, B 53, H 59	5	100% blank	21
9515000002.700.900	L 1516, B 53, H 59	7	100% blank	21
<b>Module 3000</b>				
9530000002.500.900	L 3016, B 53, H 59	5	100% blank	21
9530000002.700.900	L 3016, B 53, H 59	7	100% blank	21
<b>Module 4500</b>				
9545000002.500.900	L 4516, B 53, H 59	5	100% blank	21
9545000002.700.900	L 4516, B 53, H 59	7	100% blank	21

## Product overview | Continuous line luminaire module with diffuser opal

### Continuous line luminaire | LINEDO 50 – opal diffuser

Type of protection: IP 40  
 Protection class: I  
 Impact resistance: IK03  
 Operating range: -20°C to +50°C

Rapid-installation complete module for universal use as a continuous line luminaire. System profile made of profiled steel plate, coated. High-efficiency LED units with opal diffuser profile made of non-yellowing PMMA with increased proportion of indirect light.

Simple, tool-free installation of system profiles using separate accessories for cable, chain or ceiling suspension. Tool-free connection and mechanical connectors to secure. Easy selection of phase settings from outside thanks to patented system.

**Please order supply module, connection and installation accessories separately.**

**MES - MultiLumen Easy Select:** Luminous flux can be easily, quickly and centrally adjusted for the entire continuous line in 5 steps through voltage interruption. Factory setting is the highest luminous flux.

Available colour: white

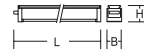

#### Coding key

##### E - Power levels DALI

00 = 6.000 lm / 1.500 mm  
 01 = 9.000 lm / 1.500 mm  
 02 = 12.000 lm / 1.500 mm

##### M - Power levels MES on/off

4.800 lm / 1.500 mm  
 6.000 lm / 1.500 mm  
 7.500 lm / 1.500 mm  
 9.000 lm / 1.500 mm  
 12.000 lm / 1.500 mm

Reference number	Dimensions [mm]	Optic	Light colour	Number of poles	Lighting control	Module arrangement	Output levels	Price category
<b>Continuous line luminaire modules with opal diffuser</b>								
<b>100% light</b>								
<b>Module 1500</b>								
951500H842.500.00M	L 1516, B 53, H 75	opal	840	5	on/off	100% light	MES	21
951500H842.776.0E	L 1516, B 53, H 75	opal	840	7	DALI	100% light	E	21
<b>Module 3000</b>								
953000H842.500.00M	L 3016, B 53, H 75	opal	840	5	on/off	100% light	MES	21
953000H842.776.0E	L 3016, B 53, H 75	opal	840	7	DALI	100% light	E	21
<b>Module 4500</b>								
954500H842.500.00M	L 4516, B 53, H 75	opal	840	5	on/off	100% light	MES	21
954500H842.776.0E	L 4516, B 53, H 75	opal	840	7	DALI	100% light	E	21

### Variant overview

#### Module 1500

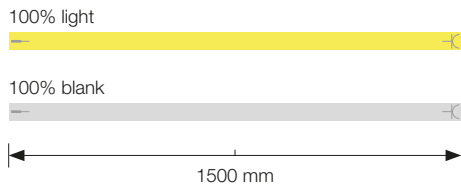

#### Module 3000

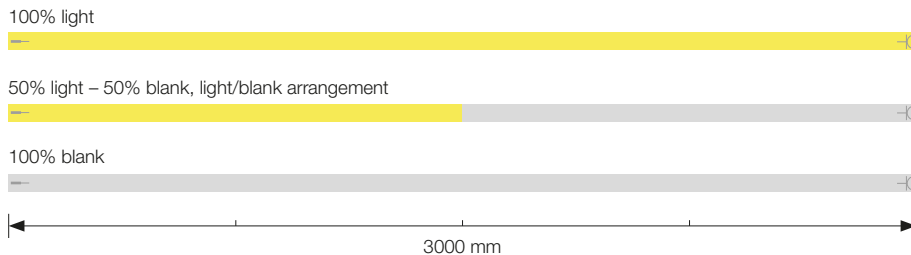

#### Module 4500

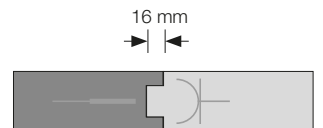
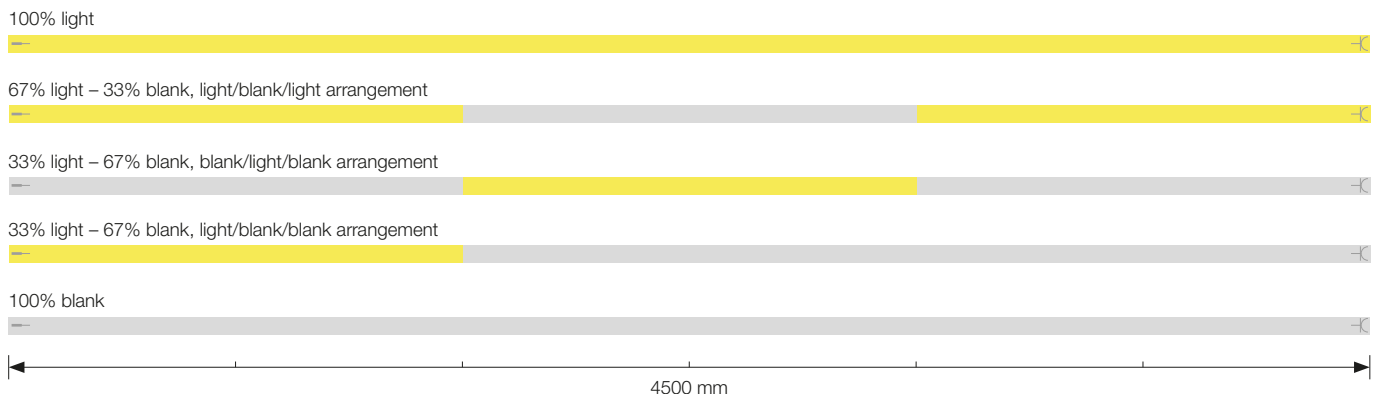

The 16 mm difference between the length in combination and that of the module alone comes from the plug and socket connection

# LINEDO 50

## Product overview | Power feeds



### Continuous line luminaire | LINEDO 50 – Initial power feed



Type of protection: IP 40  
Protection class: I

Housing, profiled steel plate, coated. Cover: plastic, white. LINEDO plug system in black plastic. 1 cable screw fitting (M25). Cable screw fitting on side or top according to preference. Convenient connection with flat connector.

Available colour: white

Reference number	Dimensions [mm]		Price category
<b>Initial power feed</b>			
<b>for LINEDO 50 modules with optical lens system</b>			
983211.002.2	L 166, B 53, H 59	7-pole socket connection	21
983211.002.3	L 150, B 53, H 59	7-pole, plug connection	21
<b>for LINEDO 50 modules with high opal diffuser</b>			
983211.002.5	L 166, B 53, H 75	7-pole socket connection	21
983211.002.6	L 150, B 53, H 75	7-pole, plug connection	21



### Continuous line luminaire | LINEDO 50 – Initial power feed with Casambi smart+free



Type of protection: IP 40  
Protection class: I

Housing, profiled steel plate, coated. Cover: plastic, white. LINEDO plug system in black plastic. 1 cable screw fitting (M25). Cable screw fitting on side or top according to preference. Convenient connection with flat connector.

Each individual line can be adjusted individually and conveniently in the Casambi app. Up to 25 DALI drivers per line possible in broadcast operation. Depending on the Casambi network, up to 250 power feeds can be linked.

Available colour: white

Reference number	Dimensions [mm]		Price category
<b>Initial power feed with Casambi smart+free</b>			
983211.002.4	L 316, B 53, H 59	7-pole socket connection	21



### Continuous line luminaire | LINEDO 50 – Middle power feed

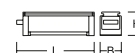

Type of protection: IP 40  
Protection class: I

Housing, profiled steel plate, coated. Cover: plastic, white. LINEDO plug system in black plastic. 2 cable screw fittings (M25). Cable screw fittings on top. Convenient connection with flat connector.

Available colour: white

Reference number	Dimensions [mm]		Price category
<b>Middle power feed</b>			
<b>for LINEDO 50 modules with optical lens system</b>			
983212.002.3	L 316, B 53, H 59	7-pole plug/socket connection	21
<b>for LINEDO 50 modules with high opal diffuser</b>			
983212.002.7	L 316, B 53, H 75	7-pole plug/socket connection	21



### Continuous line luminaire | LINEDO 50 – Universal power feed



Type of protection: IP 40  
Protection class: I

Universal power feed that can be used as initial or middle power feed for flexible installation on site. Housing, profiled steel plate, coated. Cover: plastic, white. LINEDO plug system in black plastic. 2 cable screw fittings (M25). Cable screw fittings on top. Convenient connection with flat connector.

Available colour: white

Reference number	Dimensions [mm]		Price category
<b>Universal power feed</b>			
983212.002.6	L 316, B 53, H 59	7-pole plug/socket connection	21

### Continuous line luminaire | LINEDO 50 – Connector for suspension mounting

Galvanised metal bolt to mechanically connect 2 LINEDO 50 continuous line luminaire modules. A connector must be placed at each joint between modules.

Available colour: white

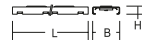

Reference number	Dimensions [mm]		Price category
<b>Connector</b>			
983174.002	L 300, B 49, H 14	Connector for suspension mounting	21

### Continuous line luminaire | LINEDO 50 – Connector for ceiling mounting

Galvanised metal bolt to mechanically connect 2 LINEDO 50 continuous line luminaire modules. A connector must be placed at each joint between modules.

Available colour: white

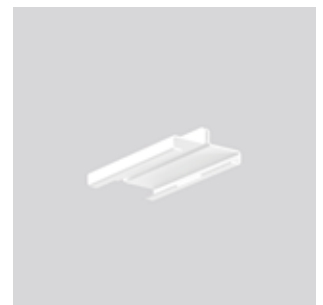
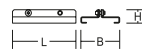

Reference number	Dimensions [mm]		Price category
<b>Connector</b>			
983218.002	L 80, B 49, H 17	Connector for ceiling mounting	21

### Continuous line luminaire | LINEDO 50 – Installation accessories

Spring steel, blank, for installing LINEDO 50 continuous line luminaire modules.

Recommended fixing distance for pendant mounting: For modules with  $L 4500 \leq 4500$  mm. For ceiling mounting, 2 adapters are required per module.

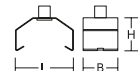

Reference number	Dimensions [mm]		Price category
<b>Installation accessories</b>			
983151.000	L 50, B 30, H 40	Suspension kit for steel cable (cable not included)	21
983151.010	L 50, B 30, H 40	Suspension kit for steel cable (cable not included) with slot hole	21
983152.000	L 50, B 30, H 90	Suspension kit with open ring (chain not included)	21
983152.010	L 50, B 30, H 90	Suspension kit with open ring (chain not included) with slot hole	21
983149.000	L 50, B 30, LP 1500	Suspension kit with chain 1500 mm	21
983156.000	L 50, B 30, LP 5000	Suspension kit with chain 5000 mm	21
983148.000	L 50, B 30, LP 1500	Suspension kit with steel cable 1500 mm	21
983155.000	L 50, B 30, LP 5000	Suspension kit with steel cable 5000 mm	21
983150.000	L 50, B 30, LP 1500	Suspension kit for grid ceilings with steel cable 1500 mm and caddy clip	21
983157.000	L 50, B 30, LP 5000	Suspension kit for grid ceilings with steel cable 5000 mm and caddy clip	21
983154.000	L 50, B 30, H 30	Adapter for mounting direct on ceiling	21
983153.000	L 50, B 30, H 45	Adapter for mounting direct on grid ceilings (caddy clip)	21

### Continuous line luminaire | LINEDO 50 – End caps

Plastic end cap to cover LINEDO plug system at the end of the line. Installation accessories included.

Available colour: white

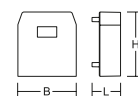

Reference number	Dimensions [mm]		Price category
<b>End caps</b>			
983213.002	L 26, B 54, H 59	Low profile end cap for LINEDO 50 socket	21
983214.002	L 12, B 54, H 59	Low profile end cap for LINEDO 50 plug	21
983215.002	L 26, B 54, H 75	High profile end cap for LINEDO 50 socket (for opal high diffuser)	21
983216.002	L 12, B 54, H 75	High profile end cap for LINEDO 50 plug (for opal high diffuser)	21

# LINEDO 50

## Sensors



### Continuous line luminaire | LINEDO 50 - Sensor modules 5-16 m

Type of protection: IP 40  
 Protection class: I  
 Operating range: -20°C ... +50°C

System profile made of aluminium extrusion profile, powder-coated (white, black) or anodised. Module including Passive Infrared (PIR) sensor for movement and ambient light. Pre-assembled connector for DALI line.

Simple, tool-free installation of system profiles using separate accessories for cable, chain or ceiling suspension. Tool-free connection and mechanical connectors to secure. Phase can be set via patented bridge without opening the luminaire.

**Please order supply module, connection and mounting accessories separately.**

Light and movement sensor: DALI-2 sensor can be individually positioned  $\pm 1$  m over the length of the system profile. Housing of non-flammable, halogen-free plastic (polycarbonate). Detection range: 30x19 m. Light sensor range: 10-2500 lx. Installation height: 5-16 m.

Example of use: Monitoring of warehouses, high-bay warehouses where there is a large installation height.

Available colour: 2 = white

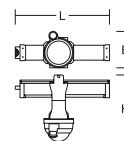

Reference number	Dimensions [mm]		Price category
<b>LINEDO 50 - Sensor modules</b>			
95030S2002.700.000	L 316, B 122, H 250	7-pole	21



### Continuous line luminaire | LINEDO 50 – Modules with Zhaga base

Type of protection: IP 40  
 Protection class: I  
 Operating range: 0°C ... +45°C with power supply;  
 -20°C ... +45°C without power supply

System profile made of profiled steel plate, coated. Cover: plastic, white. Module including Zhaga base (book 18 ED.2) for tool-free connection of sensors and light management systems. Pre-assembled connection to DALI line.

**A sensor must always be ordered with the module.**

Simple, tool-free installation of system profiles using separate accessories for cable, chain or ceiling suspension. Tool-free connection and mechanical connectors to secure. Easy selection of phase settings from outside thanks to patented system.

**Please order supply module, connection and installation accessories separately.**

**The middle power feed 983212.002.3 can be used as length compensation.**

Available colour: white



Reference number	Dimensions [mm]		Price category
<b>Modules with Zhaga base</b>			
<b>Integrated DALI power supply</b>			
95030S1002.700.000	L 316, B 53, H 59	7-pole	21
<b>Without DALI power supply</b>			
95030S1002.700.010	L 316, B 53, H 59	7-pole	21

### Continuous line luminaire | Sensor for Zhaga base – Bluetooth®

Type of protection: IP 65  
 Operating range: -20°C ... +50°C

Passive infrared light and movement sensor (PIR) for direct connection via the Zhaga base (book 18 Ed.2) to the DALI bus. The DALI-2 multi-sensor networks wirelessly via a Bluetooth® mesh network, can be configured via app and controls the LED driver via a DALI interface. Power is supplied via the DALI bus. Constant light control possible. Up to 16 DALI drivers can be connected. Housing made of non-flammable, halogen-free plastic (polycarbonate).

For installation heights of 2.8–14 m. The maximum diameter of the detection range is 36 m so an area of up to 1,000 m<sup>2</sup> can be monitored. The integrated light sensor has a working range of 4–1,000 lx.

Ultra-simple configuration and user-friendly operation via app on a smartphone or tablet. Application example: presence detection and constant light control for work and office areas.

**Only for use with sensor module with Zhaga base with integrated DALI power supply. Please order the module separately.**

Available colour: white

Reference number	Dimensions [mm]	Price category
<b>Sensor for Zhaga base Bluetooth®</b>		
982797.002	L 92, B 63, H 57	Radial coverage 21

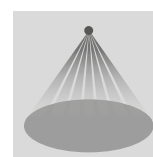

### Light management | Sensor for Zhaga base – DALI

Type of protection: IP 65  
 Operating range: -20°C ... +50°C

Far-reaching 360 passive infrared light and movement sensor (PIR) with presence and movement detection. Connected to the DALI bus via the Zhaga socket (book 18 Ed.2). The DALI-2 multisensor supplies the sensor data to the controller via the wired DALI network. Power supply via the DALI bus. Constant light control possible. Adjustable range and sensitivity. Housing made of non-flammable, halogen-free plastic (polycarbonate).

**Only for use with sensor module without Zhaga base with integrated DALI power supply. Please order the module separately.**

Available colour: white

#### With radial detection range:

For installation heights of 2.8–14 m. The maximum diameter of the detection range is 36 m so an area of up to 1,000 m<sup>2</sup> can be monitored. The integrated light sensor has a working range of 4–1,000 lx.

Application example: presence detection and constant light control for work and office areas.

Reference number	Dimensions [mm]	Price category
<b>Sensor for Zhaga base DALI</b>		
982955.002	L 92, B 63, H 57	Radial coverage 21

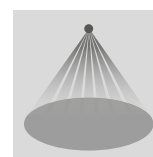

#### With rectangular detection range:

For installation heights of 4–14 m with a rectangular detection range of 30x4 m. The integrated light sensor has a working range of 4–1,000 lx.

Examples of use: presence detection and constant light control in warehouses or high-bay warehouses.

Reference number	Dimensions [mm]	Price category
<b>Sensor for Zhaga base DALI</b>		
982956.002	L 92, B 63, H 57	Rectangular coverage 21

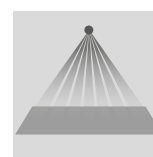

# LINEDO 50

Emergency lighting



### Continuous line luminaire | LINEDO 50 – Adapter for connection to emergency lighting

Adapter for connection to emergency lighting. Mounting plate to accommodate luminaires can be swivelled 90°. Sheet steel, powder coated. Easy to install and secure the adapter with clamp device. The luminaire can be freely positioned on the LINEDO 50 system profile using the on-site connection and control cable. The cables are attached to the system profile using cable holders.

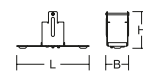

**Please order emergency luminaires separately.**

Available colour: white

Reference number	Dimensions [mm]		Price category
<b>Adapter for connection to emergency lighting</b>			
983220.002	L 245, B 57, H 136	For connection of a GSUN 5 S luminaire	21
983221.002	L 100, B 130, H 117	For connection of a Centryxx IP40 luminaire	21

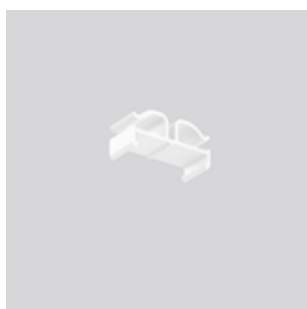

### Continuous line luminaire | LINEDO 50 – Cable holder

Cable holder. Plastic. For cable routing on the continuous line luminaire module.

Available colour: white

Reference number	Dimensions [mm]		Price category
<b>Cable holder</b>			
983219.002	L 20, B 50, H 22		21



### Escape route identification | GSUN 5 S

Type of protection: IP 54  
 Protection class: II  
 Impact resistance: IK03

Shockproof plastic (polycarbonate) housing. Display panel: highly transparent panel, plastic, with legend on one side/both sides. 4 pictogram legends (motif 3003, 3004, 3005, 3006) and 1 white foil included along with attachment pins. Large cable entry space.

Suitable for through-wiring.

Operating mode: can be connected in either non-maintained power mode or maintained power mode.

#### Self-contained emergency luminaires

Voltage type: AC

Automatic self-test in all standard versions.

With MULTIDIGIT air Bluetooth® control for wireless network and operation using Android/iOS devices, free app available for download.

#### Luminaires for central battery system

Voltage type: AC/DC

Available colour: white

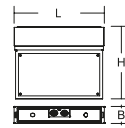

Reference number	Dimensions [mm]	↔ [m]	Mains system power [W]	Emergency system power [W]	⌚ [h]	Monitoring	Price category
<b>Self-contained emergency luminaires</b>							
672841.002	L 255, B 48, H 204	24	4	-	3	Autotest	23
672841.002.F1	L 255, B 48, H 204	24	4	-	3	MultiDigit air	23
672841.002.04	L 255, B 48, H 204	24	4	-	3	MultiDigit	23
672841.002.07	L 255, B 48, H 204	24	4	-	3	DALI-Sibe	23

#### Luminaires for central battery system

672842.002	L 255, B 48, H 204	24	2.2	2.2		Power circuit	24
672842.002.89	L 255, B 48, H 204	24	3.2	3.2		AC-Control	24

### Escape route illumination | CENTRYXX IP40

Type of protection: IP 40  
 Protection class: II  
 Impact resistance: IK03

Housing: plastic (polycarbonate). Cover: polycarbonate. Plastic lenses for area and escape route illumination included. Tool-free lens change.

Operating mode: non-maintained power mode

#### Self-contained emergency luminaires

Voltage type: AC

Automatic self-test in all standard versions.

With MULTIDIGIT air Bluetooth® control for wireless network and operation using Android/iOS devices, free app available for download.

#### Luminaires for central battery system

Voltage type: AC/DC

Available colours (X): 2 = white, 3 = black

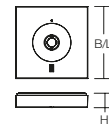

Reference number	Dimensions [mm]	Light colour	Emergency luminous flux [lm]	Emergency system power [W]	⌚ [h]	Monitoring	Price category
<b>Self-contained emergency luminaires</b>							
672582.00X	L 150, B 150, H 30	740	240/120	-	3/8	Autotest	23
672582.00X.F1	L 150, B 150, H 30	740	240/120	-	3/8	MultiDigit air	23
672582.00X.04	L 150, B 150, H 30	740	240/120	-	3/8	MultiDigit	23
672582.00X.07	L 150, B 150, H 30	740	240/120	-	3/8	DALI-Sibe	23

#### Luminaires for central battery system

672583.00X	L 150, B 150, H 30	740	310	4.6		Power circuit	24
672583.00X.89	L 150, B 150, H 30	740	310	5.6		AC-Control	24

#### Lenses

983086.000	D 16, H 10	Asymmetrical lens for areas to be highlighted					23
983172.000	D 22, H 7	Square area lens for anti-panic lighting					23
982792.002	D 26, H 15	Deep beam lens with white bracket.					23



# LIGHT MANAGEMENT SYSTEMS

## Overview



### MES - MultiLumen Easy Select

Simply brilliant. Brilliantly simple.

#### MES - MultiLumen Easy Select

Brilliantly simple: MultiLumen adjustment via the light switch. Makes on/off switching appear like light management.



### The unbeatable price / performance winner

for smaller installations

#### light control +<sup>3</sup> Economy Multi DALI

The system combines simple commissioning via smart-phone, low wiring effort and flexible configuration and is therefore ideal for group offices, conference rooms and classrooms. Programmable buttons and sensors can also be integrated via DALI connections in order to achieve even greater energy savings. The system has an integrated timer and can therefore be used to set up HCL.



### The wireless Bluetooth® light management system

for maximum functions and configuration options.

#### Casambi smart+free

Casambi smart+free solutions are particularly suitable for applications where wireless networking is required. The modules are also suitable for retrofitting in existing luminaires, as only a power supply is required. The module is already integrated into luminaires with the article number ending .730. With accessories from the extensive Casambi ecosystem, the system can be configured according to individual needs. The integration here is very intuitive and can be completed by users without prior knowledge within a few minutes.











### The future

of automated light control:  
RZB's IoT system.

#### light control +<sup>3</sup> Professional IoT

Daylight-dependent control and dynamic light control up to circadian daylight simulation in Human Centric Lighting (HCL) are easy to implement. In addition, the control system can be easily networked to make luminaire data available to other systems. Automatic switch-off functions save energy and money. All this can be configured across several rooms and floors.

We would be happy to advise you\*

	 <b>light control +<sup>3</sup> Economy Multi DALI</b>	 <b>Casambi smart+free</b>	 <b>light control +<sup>3</sup> Professional IoT</b>
			
Application	Single room	Wireless networking	Building control
Can be combined with			
Communication	wired	wireless	wired
Infrastructure requirements	L, N, PE, DA, DA (5 wires cable)	L, N, PE (3 wires cable)	L, N, PE, DA, DA (5 wires cable)
Commissioning	by electrician	by electrician	RZB service technician
Configuration	App, Plug & Play	App, Remote access	PC-Tool, Remote access
Operation	Switches, Buttons, App	Switches, Buttons, App	Switches, Buttons, App, Web access
Number of luminaires (1 EB) <small>(Number of luminaires depends on the number of EB in the luminaire)</small>	32	up to 64 depending on the module	128
Number of sensors/push-button coupler <small>(presence, motion)</small>	4	1 per module	126
Dimmable	✓	✓	✓
Motion/presence detection	✓	✓	✓
Daylight-dependent control	✓	✓	✓
Scenes/Groups	✓	✓	✓
Timer/Calendar functions	✓	✓	✓
HCL / Tunable White	✓	✓	✓
RGB		✓	✓
Network integration		✓	✓
Remote access: programming, operation, maintenance		✓	✓
IoT ready		✓	✓
Predictive maintenance, monitoring, read out luminaire data			✓
Beacon for indoor navigation, tracking, asset management		✓	
Luminaires with the reference number extension	.76 (DALI)	.730 (smart+free)	.76 (DALI)

**\*You still haven't found the right system for you?** Along with the systems shown here, we would also be happy to create a customised control system for your project. Please contact your sales persons in charge or contact our planning department via e-mail at [lms@rzb-leuchten.de](mailto:lms@rzb-leuchten.de) or by phone at +49 951 / 79 09-396.



12

Versand  
1/99

13

## Further luminaires for similar applications



LINEDO



INDUSTRIAL HALL



LIGHT CASE 2



PLANOX

## Highest product and consulting quality

### Reliability

We are your reliable partner. From the first idea to the implementation and far beyond, we accompany your project. Personal, passionate and individual. Thanks to our excellent expertise, top product quality and services such as light planning, economic efficiency analysis and commissioning, we meet the high demands of all parties involved in the planning process.

- availability of BIM files
- easy and quick installation
- high quality and long warranty

### Warranty

The creation of high quality lighting solutions is our passion. Our products are developed and manufactured with the utmost care. In addition to SMART TECHNOLOGY and EXCELLENT DESIGN, we are dedicated to manufacture luminaires of highest quality throughout the entire value chain through to After Sales Service. Because of this, we confidently grant you a 5 years warranty on LED luminaires with effect of the date of invoice without prior registration of your project. We offer a warranty of up to 10 years on luminaires of the LINEDO 50 series.

Warranty terms to be found under

[www.rzb.de/en/service/garantie/warranty-linedo-50](http://www.rzb.de/en/service/garantie/warranty-linedo-50)

**RZB - For a tangible added value.**



08.2025

**RZB**  
**Rudolf Zimmermann,**  
**Bamberg GmbH**

Rheinstr. 16  
96052 Bamberg  
Germany

Phone +49 951 79 09-374

[www.rzb-lighting.com](http://www.rzb-lighting.com)  
[export@rzb.eu](mailto:export@rzb.eu)



follow us

Member of **licht.de**