



3-CIRCUIT TRACKS

The smart solution for maximum flexibility



3-CIRCUIT TRACKS

Flexible. Adaptable. Expandable.

The smart solution for maximum flexibility

Track systems are a smart, flexible solution when it comes to targeted and efficient lighting. They allow the lighting to be easily adapted to a wide variety of room layouts and requirements. Whether in shops, offices, or at exhibitions, the luminaire can be placed exactly where it is needed, accentuating or illuminating areas to best effect.

Architecture

- ⊕ **Ideal:** Aluminium extrusion profile tracks for the most flexible mounting options with luminaires and accessories.
- ⊕ **Versatile:** Recessed and surface-mounted versions available.
- ⊕ **Optimum:** 3-circuit tracks with three electrical circuits that can be switched separately.

Lighting design

- ⊕ **Advantageous:** Integrated DALI control line for dynamic lighting tasks and human-centric lighting applications.
- ⊕ **Safe:** Approved for use within hand's reach.
- ⊕ **Compatible:** DALI track, also suitable for standard 3-circuit adaptors.

Installation

- ⊕ **Simple:** Length adjustment on site is possible by easily shortening the track.
- ⊕ **Easy installation:** Pre-drilled mounting holes allow the track to be easily attached directly to the ceiling or wall.
- ⊕ **Extensive:** Huge variety of connectors and accessories for most flexible track layouts.

3-circuit tracks



Mounting
Page 6



Surface installation
Page 7



Mounting
Page 16



Surface installation
Page 17



3-circuit tracks on/off

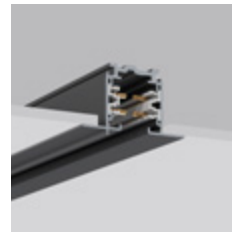

Recessed tracks

6



Surface mounted tracks

7



Electrical accessories

Power feeds

8

Connector with live feed

9

Connector

11

Point outlet | Sensor

12

Adaptor

13

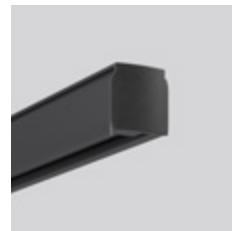

Mechanical accessories

Covers

12



Installation accessories

23



Accessories

25

Decorative hook

Socket

Bending tool

3-CIRCUIT TRACKS | ON/OFF

Tracks | Mounting

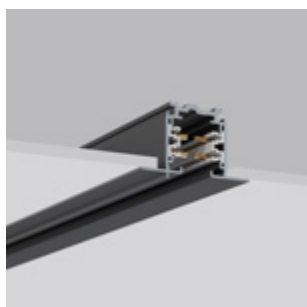

3-circuit tracks - Mounting

Type of protection: IP 20
Protection class: I

Recessed tracks. Aluminium extrusion profile, painted. Tracks can be cut to any required length. Approved for use within hand's reach.

Voltage: 250 V~ or 3-Circuit current 230/400 V max. 16 A.
Ceiling cut out width: BA 42 mm.

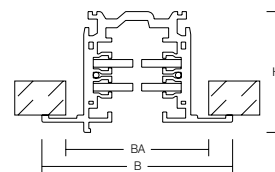

Reference number	Dimensions [mm]
------------------	-----------------

Recessed tracks

Price Category 21

Length 1000 mm

70.XTSF4100-1.004	L 1000, B 56, H 36
70.XTSF4100-2.003	L 1000, B 56, H 36
70.XTSF4100-3.002	L 1000, B 56, H 36

Colour: grey / Mounting holes: 250, 750 mm
Colour: black / Mounting holes: 250, 750 mm
Colour: white / Mounting holes: 250, 750 mm

Length 2000 mm

70.XTSF4200-1.004	L 2000, B 56, H 36
70.XTSF4200-2.003	L 2000, B 56, H 36
70.XTSF4200-3.002	L 2000, B 56, H 36

Colour: grey / Mounting holes: 250, 1000, 1750 mm
Colour: black / Mounting holes: 250, 1000, 1750 mm
Colour: white / Mounting holes: 250, 1000, 1750 mm

Length 3000 mm

70.XTSF4300-1.004	L 3000, B 56, H 36
70.XTSF4300-2.003	L 3000, B 56, H 36
70.XTSF4300-3.002	L 3000, B 56, H 36

Colour: grey / Mounting holes: 250, 1000, 2000, 2750 mm
Colour: black / Mounting holes: 250, 1000, 2000, 2750 mm
Colour: white / Mounting holes: 250, 1000, 2000, 2750 mm

Length 4000 mm

70.XTSF4400-1.004	L 4000, B 56, H 36
70.XTSF4400-2.003	L 4000, B 56, H 36
70.XTSF4400-3.002	L 4000, B 56, H 36

Colour: grey / Mounting holes: 250, 1500, 2500, 3750 mm
Colour: black / Mounting holes: 250, 1500, 2500, 3750 mm
Colour: white / Mounting holes: 250, 1500, 2500, 3750 mm

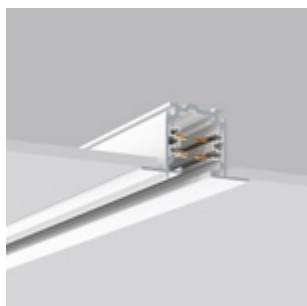
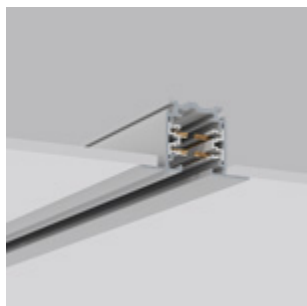

3-circuit tracks | mounting

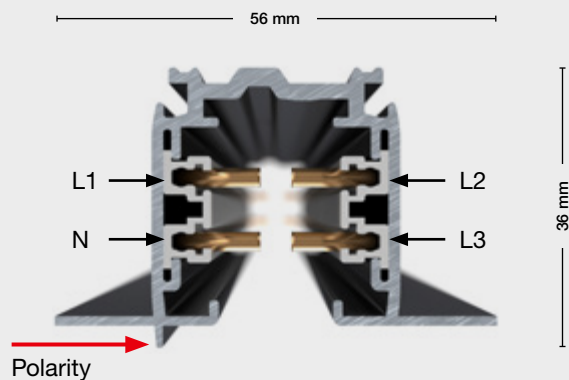

3-circuit tracks | surface installation

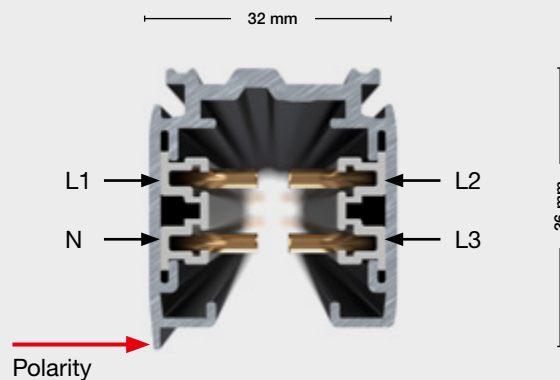

3-circuit tracks - Surface installation

Type of protection: IP 20
Protection class: I

Aluminium extrusion profile, painted. Tracks can be cut to any required length.
Approved for use within hand's reach.

Voltage: 250 V~ or 3-Circuit current 230/400 V max. 16 A.

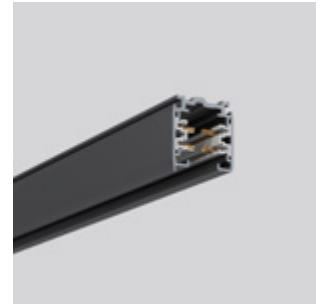
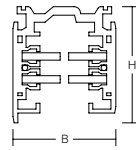

Reference number	Dimensions [mm]	
Surface mounted tracks		
Length 1000 mm		
70.XTS4100-1.004	L 1000, B 32, H 36	Colour: grey / Mounting holes: 250, 750 mm
70.XTS4100-2.003	L 1000, B 32, H 36	Colour: black / Mounting holes: 250, 750 mm
70.XTS4100-3.002	L 1000, B 32, H 36	Colour: white / Mounting holes: 250, 750 mm
Length 2000 mm		
70.XTS4200-1.004	L 2000, B 32, H 36	Colour: grey / Mounting holes: 250, 1000, 1750 mm
70.XTS4200-2.003	L 2000, B 32, H 36	Colour: black / Mounting holes: 250, 1000, 1750 mm
70.XTS4200-3.002	L 2000, B 32, H 36	Colour: white / Mounting holes: 250, 1000, 1750 mm
Length 3000 mm		
70.XTS4300-1.004	L 3000, B 32, H 36	Colour: grey / Mounting holes: 250, 1000, 2000, 2750 mm
70.XTS4300-2.003	L 3000, B 32, H 36	Colour: black / Mounting holes: 250, 1000, 2000, 2750 mm
70.XTS4300-3.002	L 3000, B 32, H 36	Colour: white / Mounting holes: 250, 1000, 2000, 2750 mm
Length 4000 mm		
70.XTS4400-1.004	L 4000, B 32, H 36	Colour: grey / Mounting holes: 250, 1500, 2500, 3750 mm
70.XTS4400-2.003	L 4000, B 32, H 36	Colour: black / Mounting holes: 250, 1500, 2500, 3750 mm
70.XTS4400-3.002	L 4000, B 32, H 36	Colour: white / Mounting holes: 250, 1500, 2500, 3750 mm

Price Category 21

Planning example 3-circuit tracks

Top view

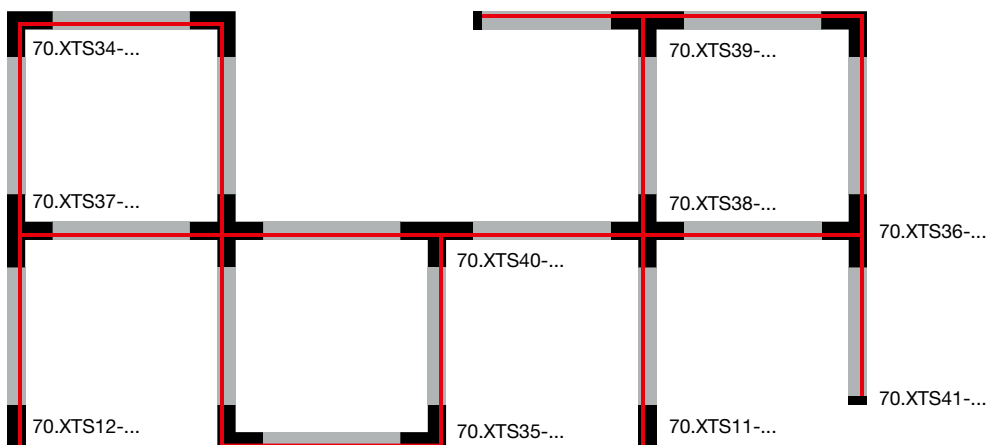

- | | | | | | |
|--|---|--|--|--|-----------------------------|
| | 70.XTS12-...
Initial power feed - Polarity right | | 70.XTS37-...
T-connector - Polarity inside right | | 70.XTS38-...
X-connector |
| | 70.XTS11-...
Initial power feed - Polarity left | | 70.XTS40-...
T-connector - Polarity inside left | | 70.XTS41-...
End cap |
| | 70.XTS34-...
L-connector - Polarity inside | | 70.XTS39-...
T-connector - Polarity outside right | | Polarity |
| | 70.XTS35-...
L-connector - Polarity outside | | 70.XTS36-...
T-connector - Polarity outside left | | |

3-CIRCUIT TRACKS | ON/OFF

Accessories | Power feeds



Initial power feed - Polarity left

Type of protection: IP 20
Protection class: I

Live end feed for 3-circuit tracks (on/off). Plastic. Suitable for recessed and surface-mounted tracks. Suitable cover required for use with recessed tracks.
Length built: LE 65 mm

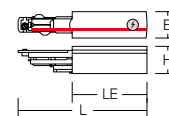

Reference number	Dimensions [mm]
------------------	-----------------

Initial power feed - Polarity left

Price Category 21

70.XTS11-1.009	L 105, B 32, H 32	Colour: grey
70.XTS11-2.003	L 105, B 32, H 32	Colour: black
70.XTS11-3.002	L 105, B 32, H 32	Colour: white



Initial power feed - Polarity right

Type of protection: IP 20
Protection class: I

Live end feed for 3-circuit tracks (on/off). Plastic. Suitable for recessed and surface-mounted tracks. Suitable cover required for use with recessed tracks.
Length built: LE 65 mm

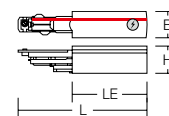

Reference number	Dimensions [mm]
------------------	-----------------

Initial power feed - Polarity right

Price Category 21

70.XTS12-1.009	L 105, B 32, H 32	Colour: grey
70.XTS12-2.003	L 105, B 32, H 32	Colour: black
70.XTS12-3.002	L 105, B 32, H 32	Colour: white



Accessories | Cover for feeds

Cover plate for alternative live feed with recessed tracks (on/off). Plastic.
Break-off point for universal use.

Cover for feeds

Price Category 21

70.XTSF10-1.009	L 109, B 56, H 4	Colour: grey
70.XTSF10-2.003	L 109, B 56, H 4	Colour: black
70.XTSF10-3.002	L 109, B 56, H 4	Colour: white



Alternative live feed

Type of protection: IP 20
Protection class: I

Alternative live feed for 3-circuit tracks (on/off). Plastic. Suitable for recessed and surface-mounted tracks. Suitable cover required for use with recessed tracks.
Length built: LE 100 mm

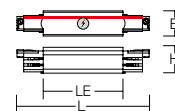

Reference number	Dimensions [mm]
------------------	-----------------

Alternative live feed

Price Category 21

70.XTS14-1.009	L 178, B 32, H 32	Colour: grey
70.XTS14-2.003	L 178, B 32, H 32	Colour: black
70.XTS14-3.002	L 178, B 32, H 32	Colour: white



Accessories | Cover for feeds

Cover plate for alternative live feed with recessed tracks (on/off). Plastic.
Break-off point for universal use.

Cover for feeds

Price Category 21

70.XTSF10-1.009	L 109, B 56, H 4	Colour: grey
70.XTSF10-2.003	L 109, B 56, H 4	Colour: black
70.XTSF10-3.002	L 109, B 56, H 4	Colour: white

L-connector - Polarity outside

Type of protection: IP 20
Protection class: I

L connector for 3-circuit tracks (on/off). Plastic. With live feed. Suitable for recessed and surface-mounted tracks. Suitable cover required for use with recessed tracks.
Length built: LE/BE 65 mm.

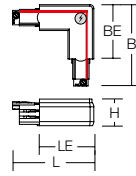

Reference number	Dimensions [mm]
------------------	-----------------

L-connector - Polarity outside

70.XTS35-1.009	L 99, B 99, H 32	Colour: grey
70.XTS35-2.003	L 99, B 99, H 32	Colour: black
70.XTS35-3.002	L 99, B 99, H 32	Colour: white

Price Category 21

L-connector - Polarity inside

Type of protection: IP 20
Protection class: I

L connector for 3-circuit tracks (on/off). Plastic. With live feed. Suitable for recessed and surface-mounted tracks. Suitable cover required for use with recessed tracks.
Length built: LE/BE 65 mm.

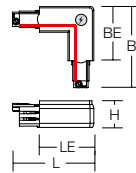

Reference number	Dimensions [mm]
------------------	-----------------

L-connector - Polarity inside

70.XTS34-1.009	L 99, B 99, H 32	Colour: grey
70.XTS34-2.003	L 99, B 99, H 32	Colour: black
70.XTS34-3.002	L 99, B 99, H 32	Colour: white

Price Category 21

Accessories | Cover plate for connector

Cover plate for L, T and X connectors for recessed tracks (on/off). Plastic.
Break-off point for universal use.

Cover plate for connector

70.XTSF30-1.009	L 109, B 109, H 4	Colour: grey
70.XTSF30-2.003	L 109, B 109, H 4	Colour: black
70.XTSF30-3.002	L 109, B 109, H 4	Colour: white

Price Category 21



X-connector

Type of protection: IP 20
Protection class: I

X connector for 3-circuit tracks (on/off). Plastic. With live feed. Suitable for recessed and surface-mounted tracks. Suitable cover required for use with recessed tracks.
Length built: LE/BE 100 mm.

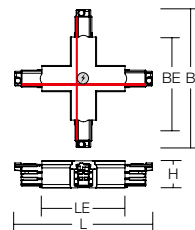

Reference number	Dimensions [mm]
------------------	-----------------

X-connector

70.XTS38-1.009	L 178, B 178, H 32	Colour: grey
70.XTS38-2.003	L 178, B 178, H 32	Colour: black
70.XTS38-3.002	L 178, B 178, H 32	Colour: white

Price Category 21

Accessories | Cover plate for connector

Cover plate for L, T and X connectors for recessed tracks (on/off). Plastic.
Break-off point for universal use.

Cover plate for connector

70.XTSF30-1.009	L 109, B 109, H 4	Colour: grey
70.XTSF30-2.003	L 109, B 109, H 4	Colour: black
70.XTSF30-3.002	L 109, B 109, H 4	Colour: white

Price Category 21



3-CIRCUIT TRACKS | ON/OFF

Accessories | Connector with live feed



T-connector - Polarity outside left

Type of protection: IP 20
Protection class: I

T-connector for 3-circuit tracks (on/off). Plastic. With live feed. Suitable for recessed and surface-mounted tracks. Suitable cover required for use with recessed tracks. Length built: LE 100 mm, BE 65 mm.

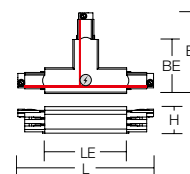

Reference number	Dimensions [mm]
------------------	-----------------

T-connector - Polarity outside left

Price Category 21

70.XTS36-1.009	L 178, B 105, H 32	Colour: grey
70.XTS36-2.003	L 178, B 105, H 32	Colour: black
70.XTS36-3.002	L 178, B 105, H 32	Colour: white



T-connector - Polarity outside right

Type of protection: IP 20
Protection class: I

T-connector for 3-circuit tracks (on/off). Plastic. With live feed. Suitable for recessed and surface-mounted tracks. Suitable cover required for use with recessed tracks. Length built: LE 100 mm, BE 65 mm.

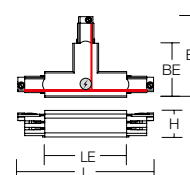

Reference number	Dimensions [mm]
------------------	-----------------

T-connector - Polarity outside right

Price Category 21

70.XTS39-1.009	L 178, B 105, H 32	Colour: grey
70.XTS39-2.003	L 178, B 105, H 32	Colour: black
70.XTS39-3.002	L 178, B 105, H 32	Colour: white



T-connector - Polarity inside left

Type of protection: IP 20
Protection class: I

T-connector for 3-circuit tracks (on/off). Plastic. With live feed. Suitable for recessed and surface-mounted tracks. Suitable cover required for use with recessed tracks. Length built: LE 100 mm, BE 65 mm.

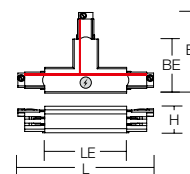

Reference number	Dimensions [mm]
------------------	-----------------

T-connector - Polarity inside left

Price Category 21

70.XTS40-1.009	L 178, B 105, H 32	Colour: grey
70.XTS40-2.003	L 178, B 105, H 32	Colour: black
70.XTS40-3.002	L 178, B 105, H 32	Colour: white



T-connector - Polarity inside right

Type of protection: IP 20
Protection class: I

T-connector for 3-circuit tracks (on/off). Plastic. With live feed. Suitable for recessed and surface-mounted tracks. Suitable cover required for use with recessed tracks. Length built: LE 100 mm, BE 65 mm.

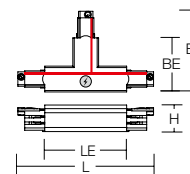

Reference number	Dimensions [mm]
------------------	-----------------

T-connector - Polarity inside right

Price Category 21

70.XTS37-1.009	L 178, B 105, H 32	Colour: grey
70.XTS37-2.003	L 178, B 105, H 32	Colour: black
70.XTS37-3.002	L 178, B 105, H 32	Colour: white



Accessories | Cover plate for connector

Cover plate for L, T and X connectors for recessed tracks (on/off). Plastic. Break-off point for universal use.

Cover plate for connector

Price Category 21

70.XTSF30-1.009	L 109, B 109, H 4	Colour: grey
70.XTSF30-2.003	L 109, B 109, H 4	Colour: black
70.XTSF30-3.002	L 109, B 109, H 4	Colour: white

Coupling

Type of protection: IP 20
Protection class: I

Coupling for 3-circuit tracks (on/off). Plastic. For electrical and mechanical connection. Suitable for recessed and surface-mounted tracks.
Length built: 0 mm.

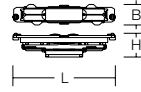

Reference number	Dimensions [mm]
------------------	-----------------

Coupling

Price Category 21

70.XTS21-1.009	L 68, B 22, H 28	Colour: grey
70.XTS21-2.003	L 68, B 22, H 28	Colour: black
70.XTS21-3.002	L 68, B 22, H 28	Colour: white

Flexible connector

Type of protection: IP 20
Protection class: I

Flexible connector for 3-circuit tracks (on/off). Plastic. For electrical and mechanical connection. Can be infinitely rotated horizontally and swivelled vertically by $\pm 180^\circ$. Suitable for surface-mounted tracks. Length built: 140-180 mm.

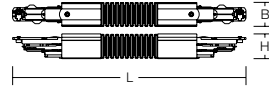

Reference number	Dimensions [mm]
------------------	-----------------

Flexible connector

Price Category 21

70.XTS23-1.009	L 255, B 32, H 32	Colour: grey
70.XTS23-2.003	L 255, B 32, H 32	Colour: black
70.XTS23-3.002	L 255, B 32, H 32	Colour: white

Joint connector

Type of protection: IP 20
Protection class: I

Joint connector for 3-circuit tracks (on/off). Plastic. For electrical and mechanical connection. Can be infinitely swivelled by $\pm 120^\circ$. Suitable for surface-mounted tracks. Length built 160 mm.

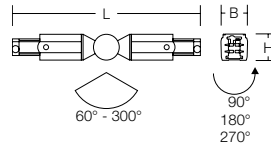

Reference number	Dimensions [mm]
------------------	-----------------

Joint connector

Price Category 21

70.XTS24-1.009	L 238, B 32, H 32	Colour: grey
70.XTS24-2.003	L 238, B 32, H 32	Colour: black
70.XTS24-3.002	L 238, B 32, H 32	Colour: white

3-CIRCUIT TRACKS | ON/OFF

Accessories | Covers | Point outlet | Sensor

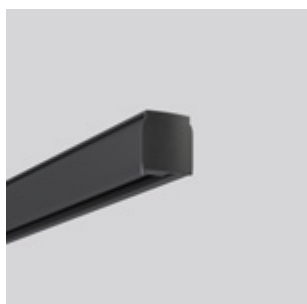

End cap

End cap for 3-circuit track (on/off and DALI). Plastic.
Suitable for recessed and surface-mounted tracks. Length built 4 mm.

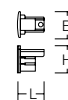

Reference number	Dimensions [mm]
------------------	-----------------

End cap

70.XTS41-1.009	L 21, B 32, H 32	Colour: grey
70.XTS41-2.003	L 21, B 32, H 32	Colour: black
70.XTS41-3.002	L 21, B 32, H 32	Colour: white

Price Category 21

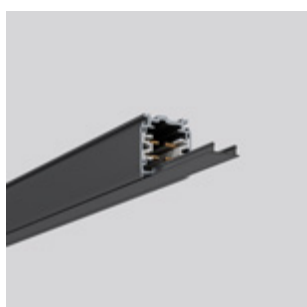

Blind cover

Blind cover for 3-circuit tracks (on/off and DALI). Plastic, UV-resistant.
Length can be shortened as required.



Reference number	Dimensions [mm]
------------------	-----------------

Blind cover

70.XTSP11-2.003	L 2000, B 18, H 6	Colour: black
70.XTSP11-3.002	L 2000, B 18, H 6	Colour: white

Price Category 21



Point outlet

Type of protection: IP 20
Protection class: I

Point outlet for multi adaptor. Plastic. For surface mounting, or recessed mounting with a separate wallbox. Cable inlets: break-off (one inlet on the side, three on the back).

Supply voltage: 10 A / 250 V, max. load capacity 5 kg.

Not suitable for versions with track-in driver and DALI integrated in the adaptor.

Available colours (X): 2 = white, 3 = black, 9 = grey

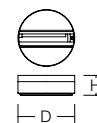

Reference number	Dimensions [mm]
------------------	-----------------

Point outlet

70319.00X	D 100, H 32
-----------	-------------

Price Category 21



Accessories | Recessed socket

Recessed socket for point outlet. Housing: plastic. Ceiling cut out 105 mm, Recessed height 60 mm.
Available colours (X): 2 = white, 3 = black, 9 = grey

Recessed socket

70360.00X	D 130, H 60
-----------	-------------

Price Category 21



Light and presence sensor Casambi smart+free

Type of protection: IP 20
Protection class: I

Casambi smart+free Bluetooth® sensor for wireless control of Casambi smart+free luminaires.
Intelligent presence control and daylight sensor. Housing: plastic.
Multi adaptor for 3-circuit tracks 230 V.

Detection range up to 7 m. Installation height: 2,4-5 m.

Available colours (X): 2 = white, 3 = black

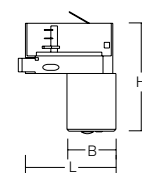

Reference number	Dimensions [mm]
------------------	-----------------

Light and presence sensor with multi-adaptor

701122.00X.19	L 70, B 39, H 59
---------------	------------------

Price Category 21

Multi adaptor GA69

Protection class: I

Multi adaptor for 3-circuit tracks from all well-known manufacturers. Plastic. Rotatable circuit selector with circuit breaker and mechanical lock.

Supply voltage 6 A / 250 V, load capacity max. 5 kg. Recessed height 19 mm.

Available colours (X): 2 = white, 3 = black, 9 = grey

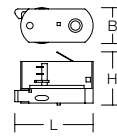

Reference number	Dimensions [mm]
------------------	-----------------

Multi adaptor		Price Category 21
701035.00X	L 70, B 35, H 51	

Accessories | Threaded nipple for adaptor

Threaded nipple for multi-adaptor and DALI adaptor. Holder with M10x1 thread. Thread length 12 mm. Aluminium.

Threaded nipple for adaptor			Price Category 21
-----------------------------	--	--	-------------------

70349	D 27, H 19	Colour: aluminium	
70349.003	D 27, H 19	Colour: black	



Accessories | Strain relief for adaptor

Strain relief for multi adaptor and DALI adaptor. Plastic. Recessed height 30 mm. Available colours (X): 2 = white, 3 = black

Strain relief for adaptor		Price Category 21
---------------------------	--	-------------------

70875.00X	D 26, H 33	
-----------	------------	--



Multi adaptor XTSA68

Protection class: I

Multi adaptor for 3-circuit tracks from all well-known manufacturers. Plastic. Rotatable circuit selector with circuit breaker and mechanical lock.

Supply voltage 10 A / 250 V, load capacity max. 10 kg. Recessed height 33 mm.

Available colours (X): 2 = white, 3 = black, 9 = grey

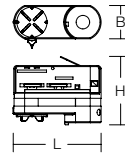

Reference number	Dimensions [mm]
------------------	-----------------

Multi adaptor		Price Category 21
70318.00X	L 85, B 32, H 63	

Accessories | Threaded nipple for adaptor

Threaded nipple for multi-adaptor and DALI adaptor. Holder with M10x1 thread. Thread length 12 mm. Aluminium.

Threaded nipple for adaptor			Price Category 21
-----------------------------	--	--	-------------------

70349	D 27, H 19	Colour: aluminium	
70349.003	D 27, H 19	Colour: black	



Accessories | Strain relief for adaptor

Strain relief for multi adaptor and DALI adaptor. Plastic. Recessed height 30 mm. Available colours (X): 2 = white, 3 = black

Strain relief for adaptor		Price Category 21
---------------------------	--	-------------------

70875.00X	D 26, H 33	
-----------	------------	--



Vorsprung
fühlen.

06

Erfahren Sie m



3-circuit tracks DALI

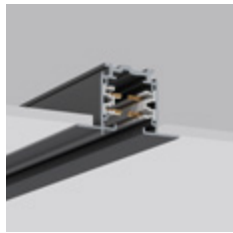

Recessed tracks 16



Surface mounted tracks 17

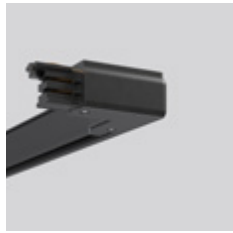

Electrical accessories
 Power feeds 18
 Connector with live feed 19
 Connector 21
 Adaptor 22

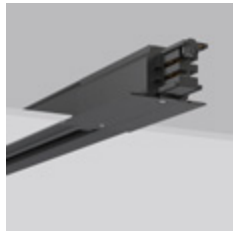

Mechanical accessories
 Covers 21



Installation accessories 23



Accessories 25
 Decorative hook
 Socket
 Bending tool

3-CIRCUIT TRACKS | DALI

Tracks | Mounting

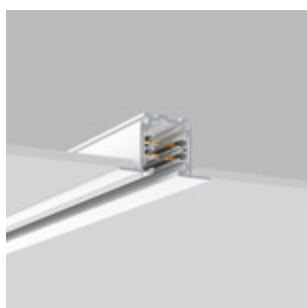
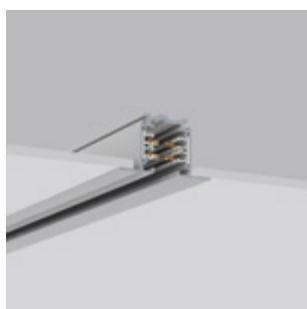
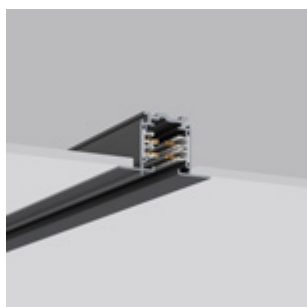

3-circuit tracks - Mounting

Type of protection: IP 20
Protection class: I

Recessed tracks. Aluminium extrusion profile, painted. Tracks can be cut to any required length. Approved for use within hand's reach. Integral added twin-pole DALI bus leads.

Power supply conductors 16 A / 400 V. DALI bus conductors 2x1 A / 50 V FELV AC.
Ceiling cut out width: BA 42 mm.

Available colours (X): 2 = white, 3 = black, 9 = grey

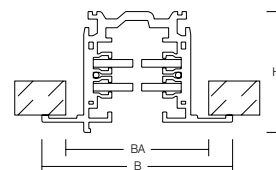

Reference number	Dimensions [mm]
------------------	-----------------

Recessed tracks

Price Category 21

Length 1000 mm

701101.00X	L 1000, B 56, H 36	Mounting holes: 250, 750 mm
------------	--------------------	-----------------------------

Length 2000 mm

701102.00X	L 2000, B 56, H 36	Mounting holes: 250, 1000, 1750 mm
------------	--------------------	------------------------------------

Length 3000 mm

701103.00X	L 3000, B 56, H 36	Mounting holes: 250, 1000, 2000, 2750 mm
------------	--------------------	--

3-circuit tracks DALI | Mounting

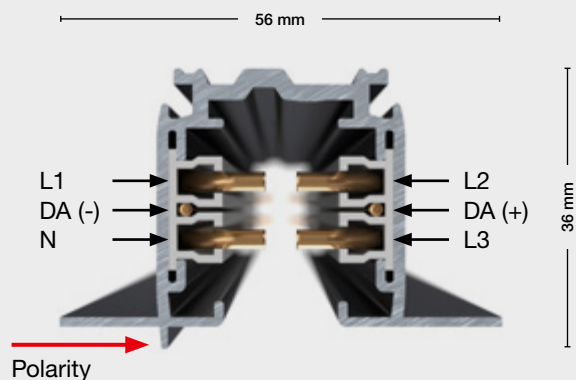

3-circuit tracks DALI | Surface installation

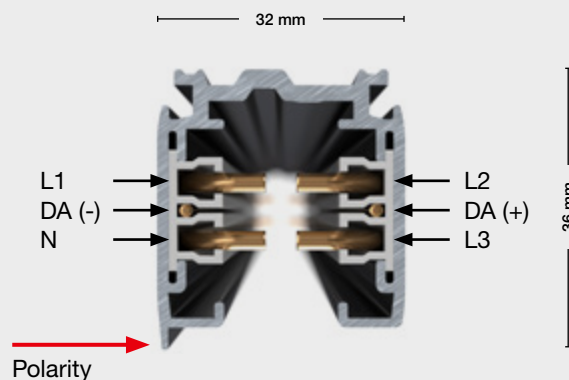

3-circuit tracks - Surface installation

Type of protection: IP 20
Protection class: I

Aluminium extrusion profile, painted. Tracks can be cut to any required length.
Approved for use within hand's reach. Integral added twin-pole DALI bus leads.

Power supply conductors 16 A / 400 V. DALI bus conductors 2x1 A / 50 V FELV AC.

Available colours (X): 2 = white, 3 = black, 9 = grey

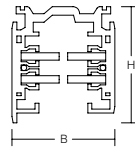

Reference number	Dimensions [mm]		Price Category 21
Surface mounted tracks			
Length 1000 mm			
701097.00X	L 1000, B 32, H 36	Mounting holes: 250, 750 mm	
Length 2000 mm			
701098.00X	L 2000, B 32, H 36	Mounting holes: 250, 1000, 1750 mm	
Length 3000 mm			
701099.00X	L 3000, B 32, H 36	Mounting holes: 250, 1000, 2000, 2750 mm	
Length 4000 mm			
701100.00X	L 4000, B 32, H 36	Mounting holes: 250, 1500, 2500, 3750 mm	

Planning example 3-circuit tracks DALI

Top view

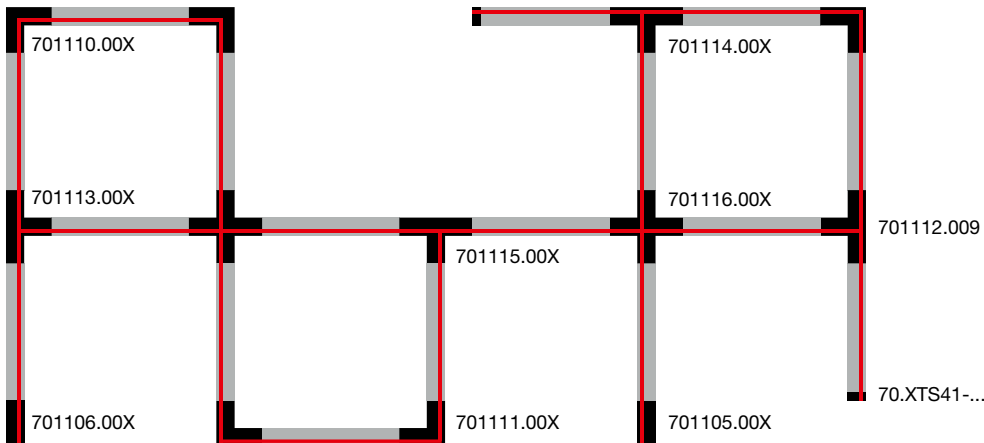

701106.00X
Initial power feed - Polarity right

701113.00X
T-connector - Polarity inside right

701116.00X
X-connector

701105.00X
Initial power feed - Polarity left

701115.00X
T-connector - Polarity inside left

70.XTS41-...
End cap

701110.00X
L-connector - Polarity inside

701114.00X
T-connector - Polarity outside right

701111.00X
L-connector - Polarity outside

701112.00X
T-connector - Polarity outside left

Polarity

3-CIRCUIT TRACKS | DALI

Accessories | Power feeds

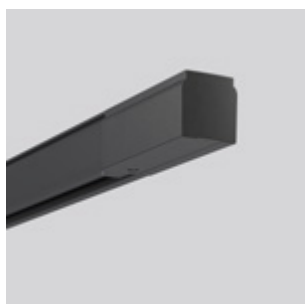

Initial power feed - Polarity left

Type of protection: IP 20
Protection class: I

Live end feed for 3-circuit tracks (DALI). Plastic. Suitable for recessed and surface-mounted tracks. Suitable cover required for use with recessed tracks.
Length built: LE 90 mm.

Available colours (X): 2 = white, 3 = black, 9 = grey

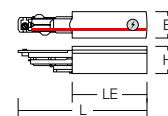

Reference number	Dimensions [mm]
------------------	-----------------

Initial power feed - Polarity left

701105.00X	L 155, B 32, H 33
------------	-------------------

Price Category 21



Initial power feed - Polarity right

Type of protection: IP 20
Protection class: I

Live end feed for 3-circuit tracks (DALI). Plastic. Suitable for recessed and surface-mounted tracks. Suitable cover required for use with recessed tracks.
Length built: LE 90 mm.

Available colours (X): 2 = white, 3 = black, 9 = grey

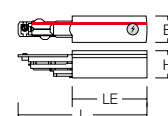

Reference number	Dimensions [mm]
------------------	-----------------

Initial power feed - Polarity right

701106.00X	L 155, B 32, H 33
------------	-------------------

Price Category 21



Accessories | Cover for feeds

Cover plate for alternative live feed with recessed tracks (DALI). Plastic.
Break-off point for universal use.

Available colours (X): 2 = white, 3 = black, 9 = grey

Cover for feeds

701117.00X	L 181, B 56, H 4
------------	------------------

Price Category 21



Alternative live feed

Type of protection: IP 20
Protection class: I

Alternative live feed for 3-circuit tracks (DALI). Plastic. Suitable for recessed and surface-mounted tracks. Suitable cover required for use with recessed tracks.
Length built: LE 170 mm.

Available colours (X): 2 = white, 3 = black, 9 = grey

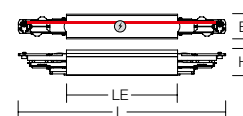

Reference number	Dimensions [mm]
------------------	-----------------

Alternative live feed

701107.00X	L 280, B 32, H 33
------------	-------------------

Price Category 21



Accessories | Cover for feeds

Cover plate for alternative live feed with recessed tracks (DALI). Plastic.
Break-off point for universal use.

Available colours (X): 2 = white, 3 = black, 9 = grey

Cover for feeds

701117.00X	L 181, B 56, H 4
------------	------------------

Price Category 21

L-connector - Polarity outside

Type of protection: IP 20
Protection class: I

L connector for 3-circuit tracks (DALI). Plastic. With live feed. Suitable for recessed and surface-mounted tracks. Suitable cover required for use with recessed tracks. Length built: LE/BE 100 mm.

Available colours (X): 2 = white, 3 = black, 9 = grey

Reference number	Dimensions [mm]
------------------	-----------------

L-connector - Polarity outside	
701111.00X	L 155, B 15, H 33

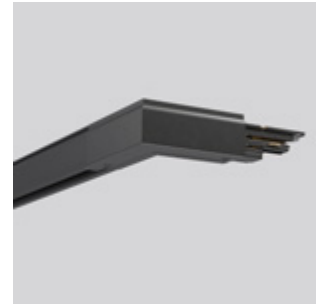
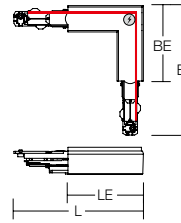

Price Category 21

L-connector - Polarity inside

Type of protection: IP 20
Protection class: I

L connector for 3-circuit tracks (DALI). Plastic. With live feed. Suitable for recessed and surface-mounted tracks. Suitable cover required for use with recessed tracks. Length built: LE/BE 100 mm.

Available colours (X): 2 = white, 3 = black, 9 = grey

Reference number	Dimensions [mm]
------------------	-----------------

L-connector - Polarity inside	
701110.00X	L 155, B 155, H 33

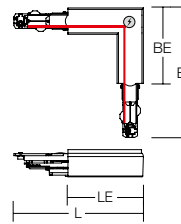

Price Category 21

Accessories | Cover plate for connector

Cover plate for L, T and X connectors for recessed tracks (DALI). Plastic. Break-off point for universal use.

Available colours (X): 2 = white, 3 = black, 9 = grey

Cover plate for connector

Reference number	Dimensions [mm]
------------------	-----------------

701118.00X	L 181, B 181, H 4
------------	-------------------

Price Category 21



X-connector

Type of protection: IP 20
Protection class: I

X connector for 3-circuit tracks (DALI). Plastic. With live feed. Suitable for recessed and surface-mounted tracks. Suitable cover required for use with recessed tracks. Length built: LE/BE 170 mm.

Available colours (X): 2 = white, 3 = black, 9 = grey

Reference number	Dimensions [mm]
------------------	-----------------

X-connector	
701116.00X	L 280, B 280, H 33

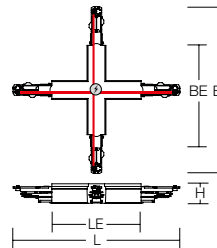

Price Category 21

Accessories | Cover plate for connector

Cover plate for L, T and X connectors for recessed tracks (DALI). Plastic. Break-off point for universal use.

Available colours (X): 2 = white, 3 = black, 9 = grey

Cover plate for connector

Reference number	Dimensions [mm]
------------------	-----------------

701118.00X	L 181, B 181, H 4
------------	-------------------

Price Category 21



3-CIRCUIT TRACKS | DALI

Accessories | Connector with live feed



T-connector - Polarity outside left

Type of protection: IP 20
Protection class: I

T-connector for 3-circuit tracks (DALI). Plastic. With live feed. Suitable for recessed and surface-mounted tracks. Suitable cover required for use with recessed tracks. Length built: LE 170 mm, BE 100 mm.

Available colours (X): 2 = white, 3 = black, 9 = grey

Reference number	Dimensions [mm]
------------------	-----------------

T-connector - Polarity outside left

701112.00X	L 280, B 155, H 33
------------	--------------------

Price Category 21

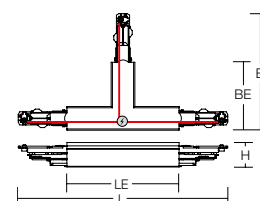

T-connector - Polarity outside right

Type of protection: IP 20
Protection class: I

T-connector for 3-circuit tracks (DALI). Plastic. With live feed. Suitable for recessed and surface-mounted tracks. Suitable cover required for use with recessed tracks. Length built: LE 170 mm, BE 100 mm.

Available colours (X): 2 = white, 3 = black, 9 = grey

Reference number	Dimensions [mm]
------------------	-----------------

T-connector - Polarity outside right

701114.00X	L 280, B 155, H 33
------------	--------------------

Price Category 21

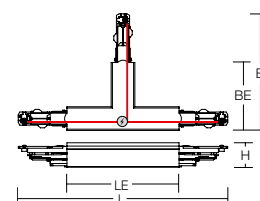

T-connector - Polarity inside left

Type of protection: IP 20
Protection class: I

T-connector for 3-circuit tracks (DALI). Plastic. With live feed. Suitable for recessed and surface-mounted tracks. Suitable cover required for use with recessed tracks. Length built: LE 170 mm, BE 100 mm.

Available colours (X): 2 = white, 3 = black, 9 = grey

Reference number	Dimensions [mm]
------------------	-----------------

T-connector - Polarity inside left

701115.00X	L 280, B 155, H 33
------------	--------------------

Price Category 21

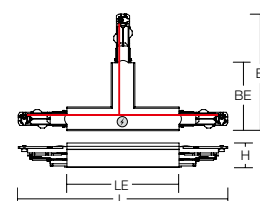

T-connector - Polarity inside right

Type of protection: IP 20
Protection class: I

T-connector for 3-circuit tracks (DALI). Plastic. With live feed. Suitable for recessed and surface-mounted tracks. Suitable cover required for use with recessed tracks. Length built: LE 170 mm, BE 100 mm.

Available colours (X): 2 = white, 3 = black, 9 = grey

Reference number	Dimensions [mm]
------------------	-----------------

T-connector - Polarity inside right

701113.00X	L 280, B 155, H 33
------------	--------------------

Price Category 21

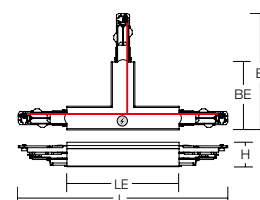

Accessories | Cover plate for connector

Cover plate for L, T and X connectors for recessed tracks (DALI). Plastic. Break-off point for universal use.

Available colours (X): 2 = white, 3 = black, 9 = grey

Cover plate for connector

701118.00X	L 181, B 181, H 4
------------	-------------------

Price Category 21

Coupling

Type of protection: IP 20
Protection class: I

Coupling for 3-circuit tracks (DALI). Plastic. For electrical and mechanical connection. Suitable for recessed and surface-mounted tracks. Length built: 0 mm.

Available colours (X): 2 = white, 3 = black, 9 = grey

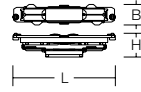

Reference number	Dimensions [mm]
------------------	-----------------

Coupling		Price Category 21
701108.00X	L 120, B 20, H 26	

Flexible connector

Type of protection: IP 20
Protection class: I

Flexible connector for 3-circuit tracks (DALI). Plastic. For electrical and mechanical connection. Can be infinitely rotated horizontally and swivelled vertically by $\pm 180^\circ$. Suitable for surface-mounted tracks. Length built: 215 mm.

Available colours (X): 2 = white, 3 = black, 9 = grey

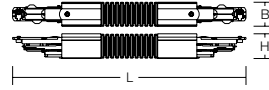

Reference number	Dimensions [mm]
------------------	-----------------

Flexible connector		Price Category 21
701109.00X	L 340, B 32, H 33	

Accessories | Covers

End cap

End cap for 3-circuit track (on/off and DALI). Plastic. Suitable for recessed and surface-mounted tracks. Length built 4 mm.

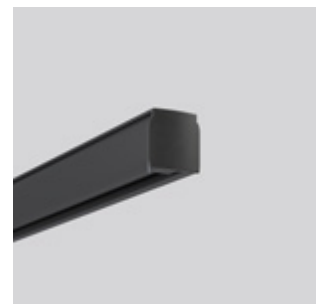

Reference number	Dimensions [mm]
------------------	-----------------

End cap			Price Category 21
70.XTS41-1.009	L 21, B 32, H 32	Colour: grey	
70.XTS41-2.003	L 21, B 32, H 32	Colour: black	
70.XTS41-3.002	L 21, B 32, H 32	Colour: white	

Blind cover

Blind cover for 3-circuit tracks (on/off and DALI). Plastic, UV-resistant. Length can be shortened as required.

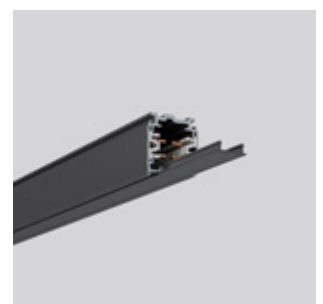

Reference number	Dimensions [mm]
------------------	-----------------

Blind cover			Price Category 21
70.XTSP11-2.003	L 2000, B 18, H 6	Colour: black	
70.XTSP11-3.002	L 2000, B 18, H 6	Colour: white	

3-CIRCUIT TRACKS | DALI

Accessories | Adaptor



DALI adaptor GAC69L

Protection class: I
 DALI adaptor for RZB 3-circuit DALI tracks. Plastic.
 Circuit selector with circuit breaker and mechanical lock.
 Supply voltage 6 A / 250 V, load capacity max. 5 kg.
 Recessed height 30 mm.
 Available colours (X): 2 = white, 3 = black, 9 = grey

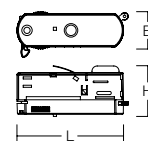

Reference number

DALI adaptor	Price Category 21
701055.02X	

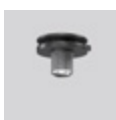

Accessories | Threaded nipple for adapter

Threaded nipple for multi-adaptor and DALI adaptor. Holder with M10x1 thread. Thread length 12 mm. Aluminium.

Threaded nipple for adapter

Price Category 21

70349	D 27, H 19	Colour: aluminium
70349.003	D 27, H 19	Colour: black



Accessories | Strain relief for adapter

Strain relief for multi adaptor and DALI adaptor. Plastic. Recessed height 30 mm.
 Available colours (X): 2 = white, 3 = black

Strain relief for adapter

Price Category 21

70875.00X	D 26, H 33
-----------	------------



DALI adaptor GAC600

Protection class: I
 DALI adaptor for RZB 3-circuit DALI tracks. Plastic.
 Circuit selector with circuit breaker and mechanical lock.
 Supply voltage 10 A / 250 V, load capacity max. 10 kg.
 Recessed height 30 mm.
 Available colours (X): 2 = white, 3 = black, 9 = grey

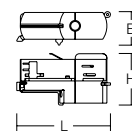

Reference number Dimensions [mm]

DALI adaptor	Price Category 21
701055.01X	L 105, B 39, H 62

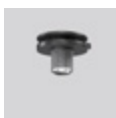

Accessories | Threaded nipple for adapter

Threaded nipple for multi-adaptor and DALI adaptor. Holder with M10x1 thread. Thread length 12 mm. Aluminium.

Threaded nipple for adapter

Price Category 21

70349	D 27, H 19	Colour: aluminium
70349.003	D 27, H 19	Colour: black



Accessories | Strain relief for adapter

Strain relief for multi adaptor and DALI adaptor. Plastic. Recessed height 30 mm.
 Available colours (X): 2 = white, 3 = black

Strain relief for adapter

Price Category 21

70875.00X	D 26, H 33
-----------	------------

Mechanical longitudinal connector

Mechanical longitudinal connector for stabilisation, with recesses for ceiling mounting accessories. Aluminium painted. Required as joint connector for suspension.

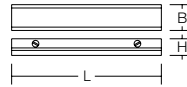

Reference number Dimensions [mm]

Mechanical longitudinal connector

Reference number	Dimensions [mm]	Colour
70.SKB18-1.004	L 182, B 31, H 20	Colour: aluminium
70.SKB18-2.003	L 182, B 31, H 20	Colour: black
70.SKB18-3.002	L 182, B 31, H 20	Colour: white

Price Category 21

Clip with eye ring

Clamp unit for tracks, with M6 eyelet for suspension. Stainless steel. A distance of approx. 1.5 m between two clamps is recommended.

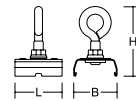

Reference number Dimensions [mm]

Clip with eye ring

Reference number	Dimensions [mm]	Colour
701094.010	L 30, B 28, H 44	Colour: stainless steel

Price Category 21

Hanging clamp

Screw clamp fastening for track with recess for suspension mounting accessories. Metal, galvanised. A distance of approx. 1.5 m between two clamps is recommended.



Reference number Dimensions [mm]

Hanging clamp

Reference number	Dimensions [mm]	Colour
70.SKB16-1.004	L 25, B 32, H 39	Colour: aluminium
70.SKB16-2.003	L 25, B 32, H 39	Colour: black
70.SKB16-3.002	L 25, B 32, H 39	Colour: white

Price Category 21

Ceiling installation

Clamp unit for ceiling-mount tracks. Aluminium painted. A distance of approx. 1.5 m between two clamps is recommended.

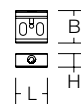

Reference number Dimensions [mm]

Ceiling installation

Reference number	Dimensions [mm]	Colour
70.SKB12-1.004	L 30, B 32, H 13	Colour: aluminium
70.SKB12-2.003	L 30, B 32, H 13	Colour: black
70.SKB12-3.002	L 30, B 32, H 13	Colour: white

Price Category 21

3-CIRCUIT TRACKS

Accessories | Installation accessories



Mount for installation in grid ceilings

Clamp unit for circuit tracks, for installation on grid ceilings with 24 mm mounting rails. Metal, galvanised. A distance of approx. 1.5 m between two clamps is recommended.

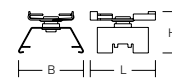

Reference number	Dimensions [mm]
------------------	-----------------

Mount for installation in grid ceilings

Price Category 21

70.SKB11T-3.002	L 66, B 41, H 16	Colour: white
70.SKB11T-1.004	L 70, B 33, H 15	Colour: aluminium
70.SKB11T-2.003	L 70, B 33, H 15	Colour: black



Cable suspension

Suspension length LP: 100-5000 mm

Suspension kit with bracket for track. Steel cable Ø 1.2 mm, pendant length 5 m, steplessly adjustable, with quick adjustment system, ceiling mounting material included.

Max. load capacity 16 kg. A distance of approx. 1.5 m between two clamps is recommended.

Available colours (X): 2 = white, 3 = black, 4 = stainless steel

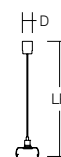

Reference number	Dimensions [mm]
------------------	-----------------

Cable suspension

Price Category 21

01-8524.13X	D 12, LP 100-5000
-------------	-------------------



Cable suspension with trapeze sheet metal hook

Suspension length LP: 100-5000 mm

Cable suspension with trapeze sheet metal hook and clamps for tracks. Steel cable Ø 1.2 mm, pendant length 5 m, steplessly adjustable, with quick adjustment system. Max. load capacity 16 kg. A distance of approx. 1.5 m between two clamps is recommended.

Available colours (X): 0 = stainless steel, 2 = white, 3 = black

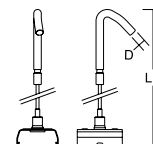

Reference number	Dimensions [mm]
------------------	-----------------

Cable suspension with trapeze sheet metal hook

Price Category 21

01-8524.47X	D 5, LP 100-5000
-------------	------------------



Cable suspension with eyelet

Suspension length LP: 100-5000 mm

Cable suspension with eyelet and clamp for tracks. Steel cable Ø 1.2 mm, pendant length 5 m, steplessly adjustable, with quick adjustment system. Max. load capacity 16 kg. A distance of approx. 1.5 m between two clamps is recommended.

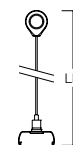

Reference number	Dimensions [mm]
------------------	-----------------

Cable suspension with eyelet

Price Category 21

01-8524.374	LP 100-5000	Colour: inox
-------------	-------------	--------------

Suspension kit with traverse

Suspension length LP: 230-5000 mm

Suspension kit with cross traverse and bracket for track. Avoids twisting in case of asymmetrical loads. Steel cable Ø 1.2 mm, pendant length 5 m, steplessly adjustable, with quick adjustment system, ceiling mounting material included. Max. load capacity 16 kg. A distance of approx. 1.5 m between two clamps is recommended.

Available colours (X): 0 = blank, 2 = white, 3 = black

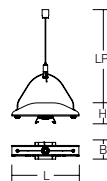

Reference number	Dimensions [mm]
------------------	-----------------

Suspension kit with traverse		Price Category 21
701096.01X	L 120, B 19, H 24, LP 230-5000	

Decorative hook

Decorative hook for integration in track. Plastic/steel. Max. load capacity 10 kg. Recessed height 37 mm.

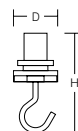

Reference number	Dimensions [mm]
------------------	-----------------

Decorative hook		Price Category 21
70382.003	D 26, H 60	Colour: black
70382.000	D 26, H 60	Colour: white

Multi adapter with socket

Protection class: I

Multi adaptor with protective contact socket for 3-circuit tracks from all well-known manufacturers. Plastic. Rotatable circuit selector with circuit breaker and mechanical lock. Socket only for lighting or lighting accessories.

Supply voltage: 10 A / 250 V.

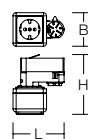

Reference number	Dimensions [mm]
------------------	-----------------

Multi adapter with socket		Price Category 21
70316.002	L 90, B 57, H 73	Colour: white

Bending tool

Tool for bending copper conductors in tracks. For tracks cut to length on site, the ends of the copper conductors must be angled so that an connection can be established.

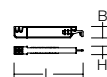

Reference number	Dimensions [mm]
------------------	-----------------

Bending tool		Price Category 21
70348.000	L 133, B 22, H 14	

Psychiatrie ab 1900

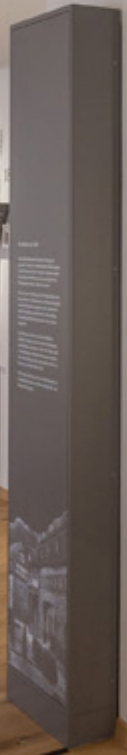



LECKER LEICHT
LUFTIG SCHMACKHAFT

Tolle
BACK

LIGHT MANAGEMENT SYSTEMS

Overview



The unbeatable price / performance winner

for smaller installations

light control +³ Economy Multi DALI

The system combines simple commissioning via smartphone, low wiring effort and flexible configuration and is therefore ideal for group offices, conference rooms and classrooms. Programmable buttons and sensors can also be integrated via DALI connections in order to achieve even greater energy savings. The system has an integrated timer and can therefore be used to set up HCL.



The wireless Bluetooth® light management system

for maximum functions and configuration options.

Casambi smart+free

Casambi smart+free solutions are particularly suitable for applications where wireless networking is required. The modules are also suitable for retrofitting in existing luminaires, as only a power supply is required. The module is already integrated into luminaires with the article number ending .730. With accessories from the extensive Casambi ecosystem, the system can be configured according to individual needs. The integration here is very intuitive and can be completed by users without prior knowledge within a few minutes.









The future

of automated light control: RZB's IoT system.

light control +³ Professional IoT

Daylight-dependent control and dynamic light control up to circadian daylight simulation in Human Centric Lighting (HCL) are easy to implement. In addition, the control system can be easily networked to make luminaire data available to other systems. Automatic switch-off functions save energy and money. All this can be configured across several rooms and floors.

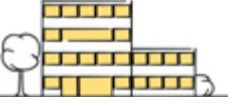
We would be happy to advise you*

	 light control +³ Economy Multi DALI	 Casambi smart+free	 light control +³ Professional IoT
			
Application	Single room	Wireless networking	Building control
Can be combined with			
Communication	wired	wireless	wired
Infrastructure requirements	L, N, PE, DA, DA (5 wires cable)	L, N, PE (3 wires cable)	L, N, PE, DA, DA (5 wires cable)
Commissioning	by electrician	by electrician	RZB service technician
Configuration	App, Plug & Play	App, Remote access	PC-Tool, Remote access
Operation	Switches, Buttons, App	Switches, Buttons, App	Switches, Buttons, App, Web access
Number of luminaires (1 EB) <small>(Number of luminaires depends on the number of EB in the luminaire)</small>	32	up to 64 depending on the module	128
Number of sensors/push-button coupler <small>(presence, motion)</small>	4	1 per module	126
Dimmable	✓	✓	✓
Motion/presence detection	✓	✓	✓
Daylight-dependent control	✓	✓	✓
Scenes/Groups	✓	✓	✓
Timer/Calendar functions	✓	✓	✓
HCL / Tunable White	✓	✓	✓
RGB		✓	✓
Network integration		✓	✓
Remote access: programming, operation, maintenance		✓	✓
IoT ready		✓	✓
Predictive maintenance, monitoring, read out luminaire data			✓
Beacon for indoor navigation, tracking, asset management		✓	
Luminaires with the reference number extension	.76 (DALI)	.730 (smart+free)	.76 (DALI)

***You still haven't found the right system for you?** Along with the systems shown here, we would also be happy to create a customised control system for your project. Please contact your sales persons in charge or contact our planning department via e-mail at lms@rzb-leuchten.de or by phone at +49 951 / 79 09-396.



Sesels Pizzeria
VAN GOGG Slijst

Winkel

© Linus Linne

3-CIRCUIT TRACKS

Discover the possibilities...

Suitable luminaires for tracks:



TX-MOVE



BEAMLINE SLIM



ARLINE



CALIDO CLICKBEAM



DEECOS S micro



DEECOS S mini track-in



DEECOS S mini



DEECOS S maxi

Highest product and consulting quality

Reliability

We are your reliable partner. From the first idea to the implementation and far beyond, we accompany your project. Personal, passionate and individual. Thanks to our excellent expertise, top product quality and services such as light planning, economic efficiency analysis and commissioning, we meet the high demands of all parties involved in the planning process.

- availability of BIM files
- easy and quick installation
- high quality and long warranty

Warranty

The creation of high quality lighting solutions is our passion.

Our products are developed and manufactured with the utmost care.

In addition to SMART TECHNOLOGY and EXCELLENT DESIGN, we are dedicated to manufacture luminaires of highest quality throughout the entire value chain through to After Sales Service.

Because of this, we confidently grant you a 5 years warranty on LED luminaires with effect of the date of invoice without prior registration of your project.

Warranty terms to be found under
www.rzb.de/en/service/warranty

RZB - For a tangible added value.



follow us

licht.de