

INSTRUCTION

Rounded Midi
582114.002



~ 220 - 240 V 50/60 Hz IP 66 IK10



Umgebungstemperatur /
temperature ambiante
=> -20 °C ... + 45 °C

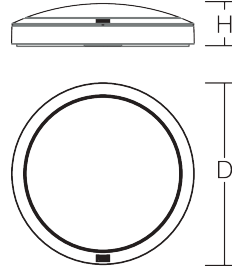

D 300, H 71



1,9 kg



Φ [lm]

P_{\square} [W]

P_{\circ}

LED

1150

9,5

1 x 4 W

CCT [K]

CRI

RG \square

EEK \square

3000

80

RG 1

D

I_{max} $I_{max}/2$
T50

B10 [St.]

B16 [St.]

C10 [St.]

C16 [St.]

$\cos \varphi$

5 A / 50 μ s

31

50

52

85

0,95





Installation erfordert
Elektro-Fachkraft!

Symbole nach ISO 7010



Allgemeine Sicherheitshinweise

- Der elektrische Anschluss muss ordnungsgemäß nach geltenden Normen und den nationalen sowie internationalen Sicherheits- und Unfallverhütungsvorschriften erfolgen.
- Beschädigte Leuchten dürfen nicht betrieben werden.
- Keine Haftung für Schäden durch unsachgemäßen Einsatz.
- Bei Instandsetzung nur Originalteile verwenden.
- Tragfähigkeit der Decke und Befestigungselemente sicherstellen.

Betrieb der Leuchte

- Die unzulässigen Umgebungstemperaturen reduzieren die Lebensdauer der Leuchte, im Extremfall droht der Frühausfall.
- Zur Vermeidung von EMV-Problemen die Durchgangsverdrahtung nicht entlang der Leuchtenverdrahtung führen.
- Steuereingänge von dimmbaren Leuchten mit handelsüblichen für Netzspannung geeigneten Leitungen anschließen.

Manipulationen unserer Produkte sind unzulässig

Veränderung, Umarbeitung, Umkennzeichnung von Produkten sowie deren Verpackung sind unzulässig und verletzen u.a. unsere eingetragenen Warenzeichenrechte. Solche Modifikationen können technische Eigenschaften unserer Produkte negativ beeinflussen, diese zerstören und möglicherweise Folgeschäden an anderen Objekten verursachen. Für durch derartige Modifikationen verursachte Schäden kann der Hersteller in keinem Fall verantwortlich gemacht werden.



Installation requires
a qualified electrician!

Symbols according
to ISO 7010



General Safety Information

- Electric connection must be appropriate according to all applicable standards and other national and international safety and accident prevention regulations.
- Damaged luminaires must not be operated.
- No liability is accepted for damages resulting from improper use.
- Use genuine parts only for repair.
- Ensure stability of the ceiling and fastening elements.

Operation of the luminaire

- Exceeding the permissible ambient temperature will reduce the luminaire's lifecycle, resulting in premature failure in extreme cases.
- Avoid ESD problems by not routing feed-through wiring directly along the wiring of the luminaire.
- Connect control inputs of dimmable luminaires with standard cables suitable for power supply voltage.

Manipulation of our products is not permitted

Modifications, reworking, re-labelling of products as well as their package is not permitted and infringes, amongst others, our registered trademark rights. Such modifications may affect technical properties of our products, damage them and possibly cause consequential damage to other objects. The manufacturer shall not be responsible under any circumstances for damage caused by such modifications.



Bei Fragen zu unseren Symbolen, besuchen Sie folgende Webseite:
If you have any questions about our signs, visit the following website:





https://www.rzb.de/fileadmin/assets/downloads/PDF/RZB_Symbolklaerung.pdf

EEK 



Dieses Produkt enthält eine Lichtquelle der Energieeffizienzklasse D entsprechend Verordnung (EU) 2019/2015

This product contains a light source of energy efficiency class D according to regulation (EU) No 2019/2015

 →  Jede zersprungene Schutzabdeckung ist zu ersetzen. DIN EN 60598

 →  Replace any cracked protective shield. IEC DIN EN 60598

Hinweis zum Einsatz von Leuchten mit D - Kennzeichnung nach EN 60598-2-24
Reference for application of lumiaires with D - marking according to EN 60598-2-24

	<u>Umgebung ohne Staubablagerung</u> Environment without dust deposit
	<u>Umgebung mit nicht elektrisch leitender Staubablagerung</u> Environment with non-electrically conductive dust deposit
	<u>Umgebung mit elektrisch leitender Staubablagerung</u> Environment with electrically conductive dust deposit

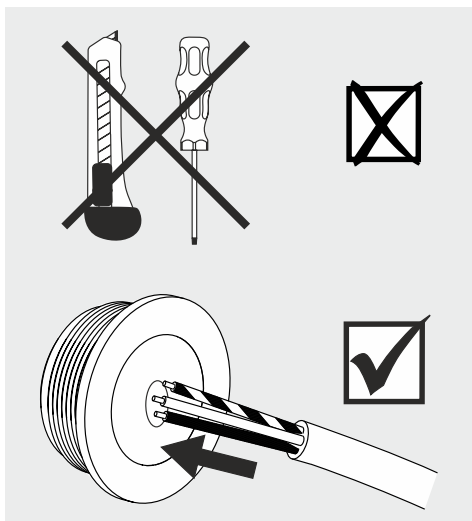
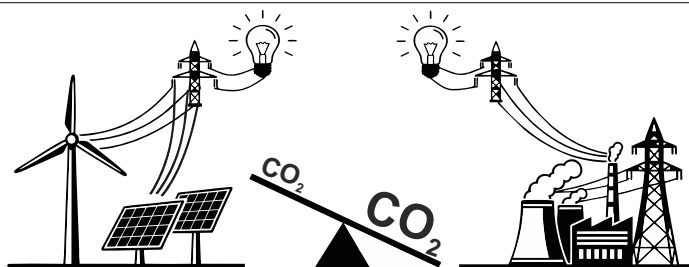

Ersatzteil
Spare part

2x



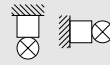

1

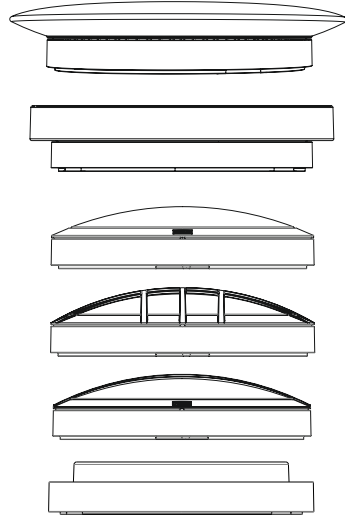
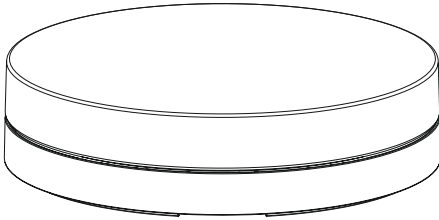

2

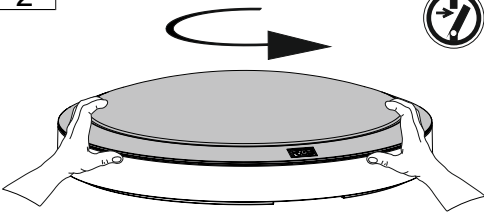

3

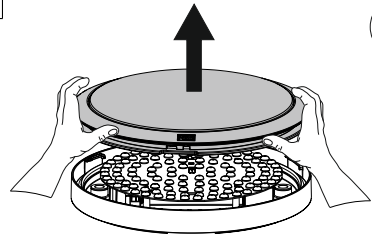

4

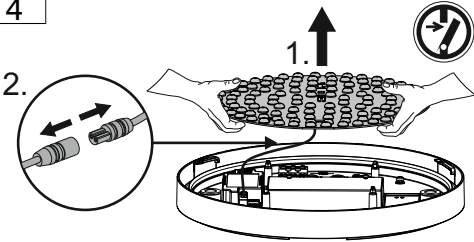

5

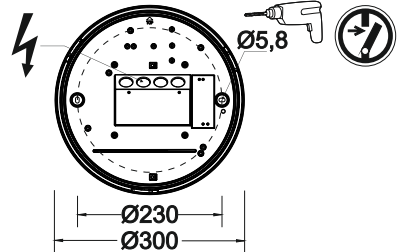

6

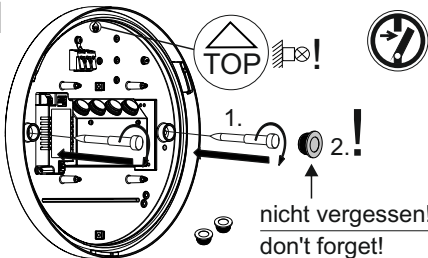

7

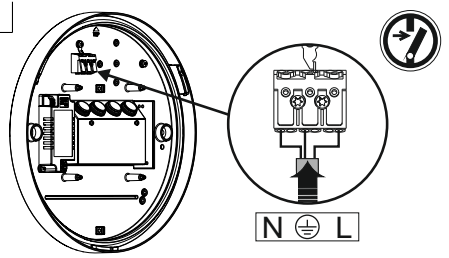



8

Konvertereinstellung / Converter setting

SEC	1	2	3	4	
250 mA	-	-	-	-	↙ 3000K → 1100-1150lm
280 mA	-	-	-	ON	↘ 4000K → 1100-1200lm
310 mA	-	-	ON	-	
340 mA	-	-	ON	ON	
370 mA	-	ON	-	-	
400 mA	-	ON	-	ON	
430 mA	-	ON	ON	-	
460 mA	-	ON	ON	ON	
490 mA	ON	-	-	-	
520 mA	ON	-	-	ON	
550 mA	ON	-	ON	-	
580 mA	ON	-	ON	ON	
610 mA	ON	ON	-	-	
640 mA	ON	ON	-	ON	
670 mA	ON	ON	ON	-	↙ 3000K → 3000-3150lm
700 mA	ON	ON	ON	ON	↘ 4000K → 3100-3250lm

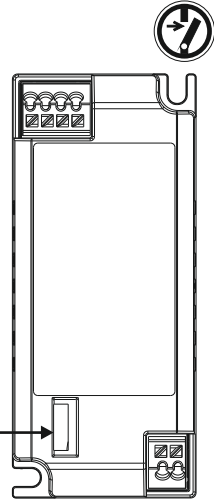

9

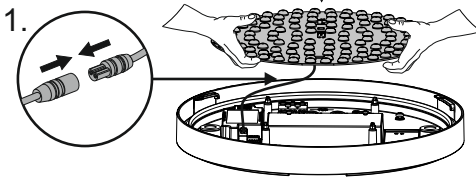

10

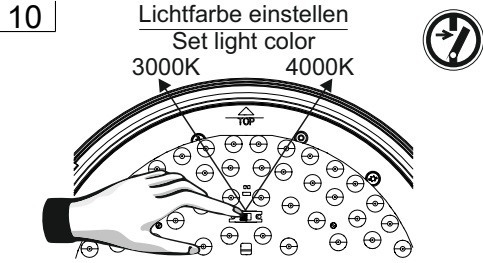

11

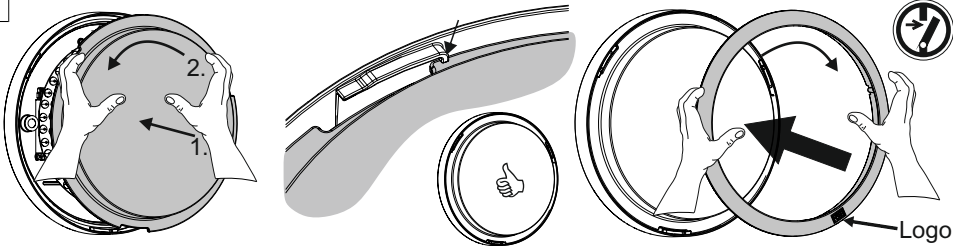

12

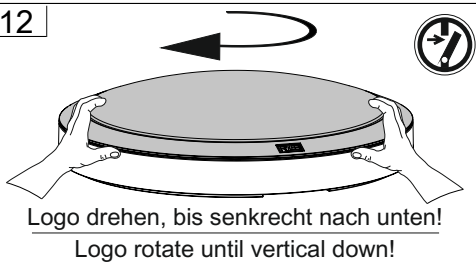

13

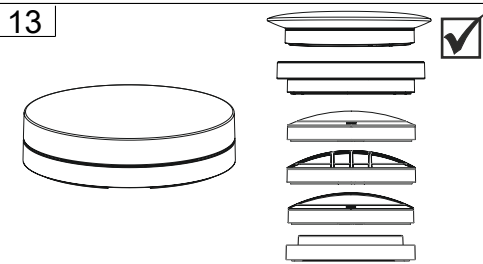

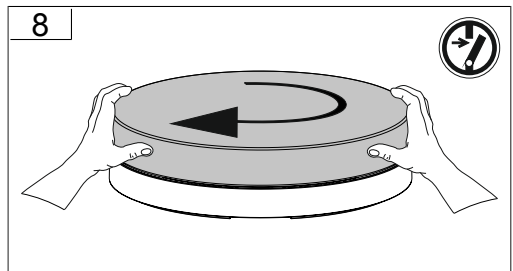

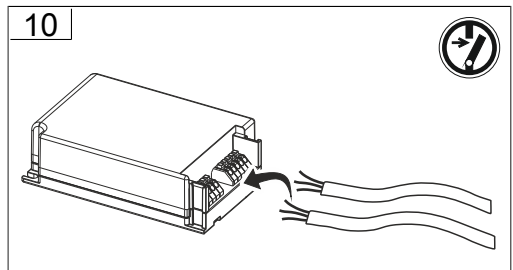
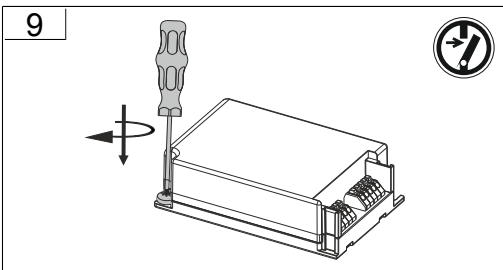
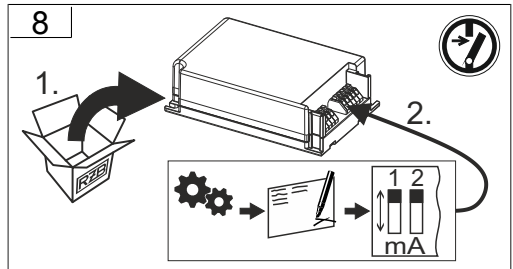
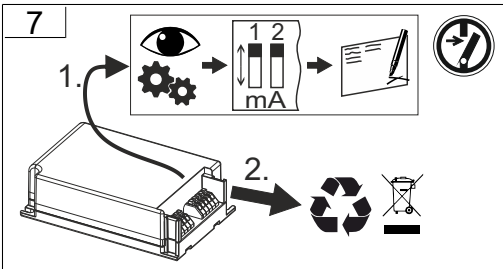
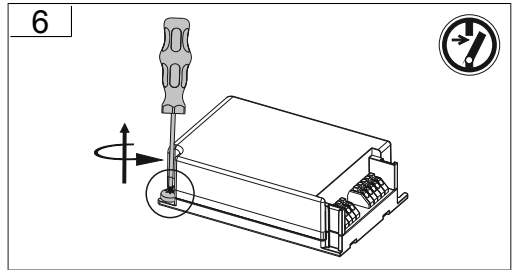
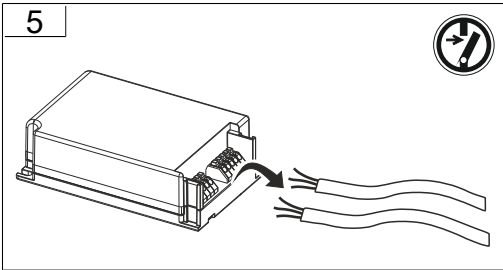
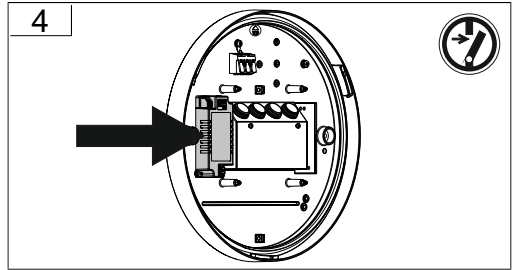
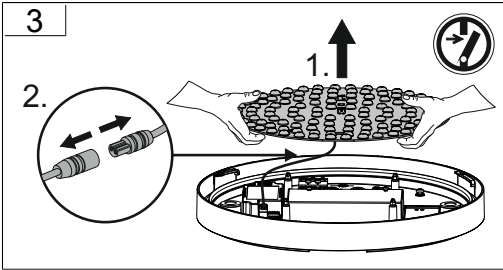

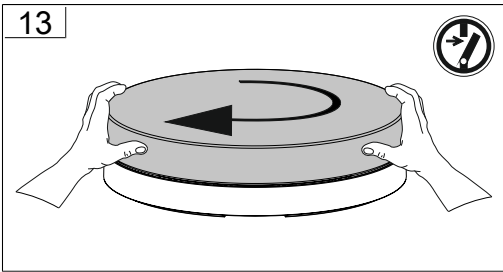
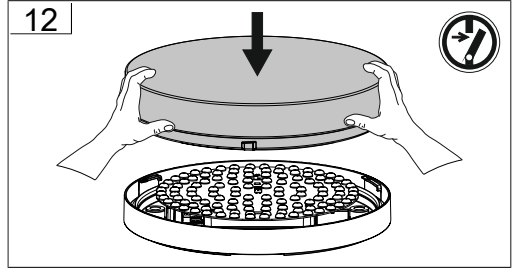
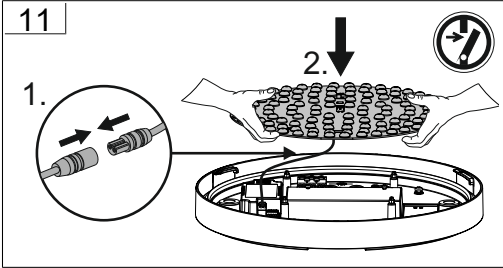

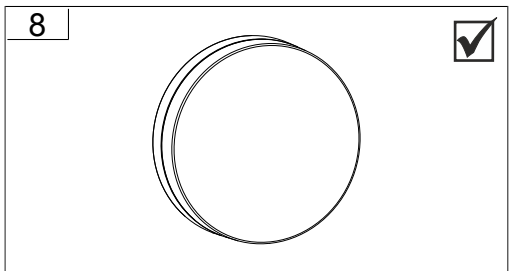
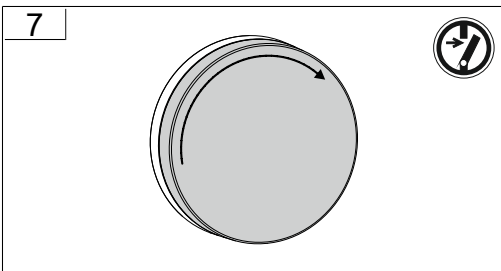
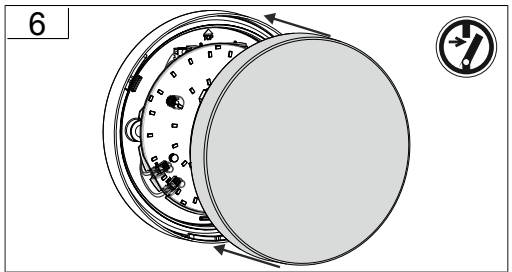
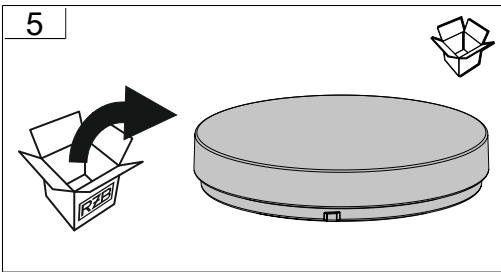
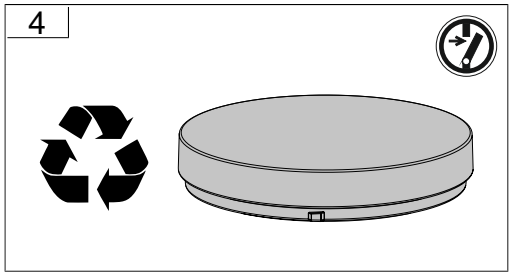
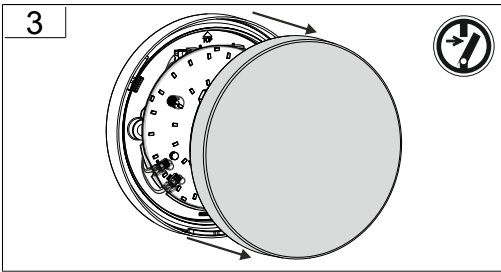
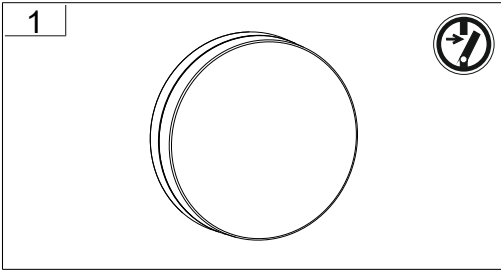











RZB - Rudolf Zimmermann, Bamberg GmbH

🏠 Rheinstraße 16, 96052 Bamberg

☎ 0951/7909-0

📠 0951/7909-198

🌐 info@rzb-leuchten.de