

INSTRUCTION

LINEDO
9503RQ.762.434.00C

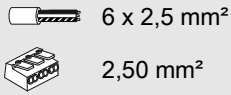

~ 220 - 240 V 50/60 Hz IP 54 IK03



Dauerschaltung / maintained
=> 5 °C ... + 30 °C
Bereitschaftsschaltung / non
maintained
=> 5 °C ... + 30 °C

3 h
 NiMH
2,4 V - 4 Ah

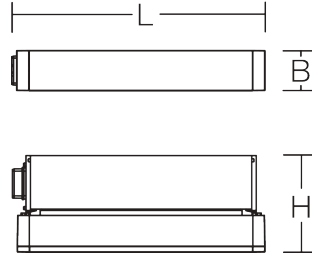
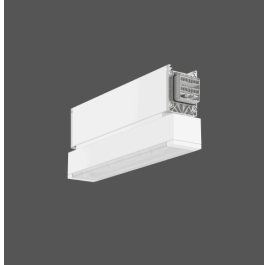

L 342, B 58, H 131

1,51 kg



Φ [lm]

P [W]

Φ [lm]

P

LED

450

6

210

1 x 3 W

CCT [K]

CRI

RG [St.]

EEK [St.]

6300

70

RG 2

D

I_{max} [A]

B10 [St.]

B16 [St.]

C10 [St.]

C16 [St.]

COS φ

120 A / 5 μ s

30

40

30

40

0,5

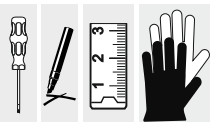



Allgemeine Sicherheitshinweise

- Der elektrische Anschluss muss ordnungsgemäß nach geltenden Normen und den nationalen sowie internationalen Sicherheits- und Unfallverhütungsvorschriften erfolgen.
- Beschädigte Leuchten dürfen nicht betrieben werden.
- Keine Haftung für Schäden durch unsachgemäßen Einsatz.
- Bei Instandsetzung nur Originalteile verwenden.
- Tragfähigkeit der Decke und Befestigungselemente sicherstellen.

Betrieb der Leuchte

- Die unzulässigen Umgebungstemperaturen reduzieren die Lebensdauer der Leuchte, im Extremfall droht der Frühausfall.
- Zur Vermeidung von EMV-Problemen die Durchgangsverdrahtung nicht entlang der Leuchtenverdrahtung führen.
- Steuereingänge von dimmbaren Leuchten mit handelsüblichen für Netzspannung geeigneten Leitungen anschließen.

Manipulationen unserer Produkte sind unzulässig

Veränderung, Umarbeitung, Umkennzeichnung von Produkten sowie deren Verpackung sind unzulässig und verletzen u.a. unsere eingetragenen Warenzeichenrechte. Solche Modifikationen können technische Eigenschaften unserer Produkte negativ beeinflussen, diese zerstören und möglicherweise Folgeschäden an anderen Objekten verursachen. Für durch derartige Modifikationen verursachte Schäden kann der Hersteller in keinem Fall verantwortlich gemacht werden.



General Safety Information

- Electric connection must be appropriate according to all applicable standards and other national and international safety and accident prevention regulations.
- Damaged luminaires must not be operated.
- No liability is accepted for damages resulting from improper use.
- Use genuine parts only for repair.
- Ensure stability of the ceiling and fastening elements.

Operation of the luminaire

- Exceeding the permissible ambient temperature will reduce the luminaire's lifecycle, resulting in premature failure in extreme cases.
- Avoid ESD problems by not routing feed-through wiring directly along the wiring of the luminaire.
- Connect control inputs of dimmable luminaires with standard cables suitable for power supply voltage.

Manipulation of our products is not permitted

Modifications, reworking, re-labelling of products as well as their package is not permitted and infringes, amongst others, our registered trademark rights. Such modifications may affect technical properties of our products, damage them and possibly cause consequential damage to other objects. The manufacturer shall not be responsible under any circumstances for damage caused by such modifications.



Bei Fragen zu unseren Symbolen, besuchen Sie folgende Webseite:

If you have any questions about our signs, visit the following website:



https://www.rzb.de/fileadmin/assets/downloads/PDF/RZB_Symbolklaerung.pdf

EEK

Dieses Produkt enthält eine Lichtquelle der Energieeffizienzklasse D entsprechend Verordnung (EU) 2019/2015

This product contains a light source of energy efficiency class D according to regulation (EU) No 2019/2015



Jede zersprungene Schutzabdeckung ist zu ersetzen. DIN EN 60598

Replace any cracked protective shield. IEC DIN EN 60598



Die Lichtquelle dieser Leuchte darf nur vom Hersteller oder einem von ihm beauftragten Servicetechniker oder einer vergleichbar qualifizierten Person ersetzt werden. DIN EN 60598-1 / IEC 60598-1

The light source contained in this luminaire shall only be replaced by the manufacturer or his service agent or a similar qualified person. DIN EN 60598-1 / IEC 60598-1



Zur Verwendung in Anlagen nach EN 50172 / DIN VDE 0108-100

For installation according to EN-50172 / DIN VDE 0108-100



Die Sicherheitsleuchten werden generell mit entladenen oder teilentladenen Akkus ausgeliefert und müssen für die volle Funktionstüchtigkeit die vorgegebene Inbetriebnahme durchlaufen.

The emergency luminaires are delivered with either discharged or only partially charged batteries and run through the specified commissioning before reaching their fully operability.



Einteilung Notleuchten

* ** *** ****

Veränderungen am Auslieferungszustand der Leuchte sind gemäß DIN EN 60598-2-22 auf dem Typenschild zu kennzeichnen.

Classification Emergency Lighting

* ** *** ****

Modifications to the delivery condition of the luminaire must be documented on the product label accordingly to IEC 60598-2-22.

















*	Typ (1-stellig)	Type (1-digit)
X	Einzelbatterie	Self-Contained
Z	Zentralbatterie	Central Supply

**	Betriebsart (1-stellig)	Operating Mode (1-digit)
0	Notleuchte Bereitschaftsschaltung	Emergency Lighting non-maintained
1	Notleuchte Dauerschaltung	Emergency Lighting maintained
2	Kombinierte Notleuchte Bereitschaftssch.	Combi. Emergency Lighting non-maintained
3	Kombinierte Notleuchte Dauerschaltung	Combined Emergency Lighting maintained

***	Einrichtungen (max. 7-stellig)	Installation (max. 7-digit)
A	manuelle Prüfeinrichtung	Manual Test Device
B	Fernschalter für Ruhe-Zustand	Including Remote Rest Mode
C	Fernausschaltemöglichkeit	Including Inhibiting Mode
D	Arbeitsstätten m. besonderer Gefährdung	High-Risk Task-Area Luminaire
E	Lampe oder Batterie nicht austauschbar	With non-replaceable Lamps or Battery
F	automatische Prüfeinrichtung	Automatic Test Device
G	von innen beleuchtetes Sicherheitszeich.	Inside illuminated safety sign

****	Betriebsdauer (2/3-stellig) (nur bei Einzelbatterie)	Duration Time (2/3-digit) (only for self-contained)
60	Betriebsdauer 60 Minuten	Duration Time 60 Minutes
180	Betriebsdauer 180 Minuten	Duration Time 180 Minutes
480	Betriebsdauer 480 Minuten	Duration Time 480 Minutes





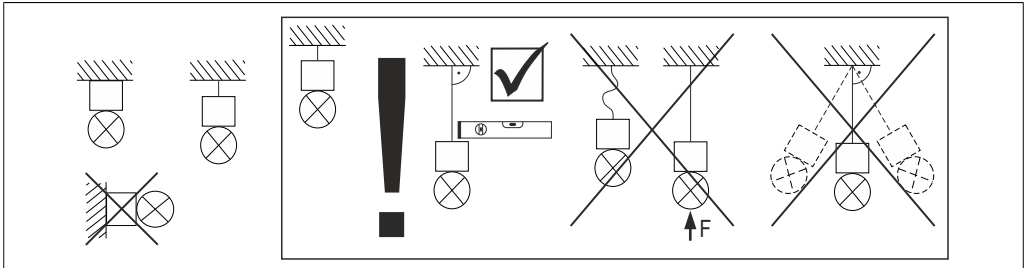

 Stecker / Plug	 Pendelmontage / Pendant mounting Einspeisung Mitte / Feed in the middle
 Buchse / Socket	 Deckenmontage / Ceiling mounting Einspeisung Mitte / Feed in the middle
 Pendelmontage / Pendant mounting	 Pendelmontage / Pendant mounting Einspeisung Anfang von oben / Feed beginning from above
 Deckenmontage / Ceiling mounting	 Deckenmontage / Ceiling mounting Einspeisung Anfang von oben / Feed beginning from above
 Verdrahtung anpassen / Adapt wiring	 Pendelmontage / Pendant mounting Einspeisung Anfang seitlich / Feed beginning from the side
 Werkseinstellungen / Factory setting	 Deckenmontage / Ceiling mounting Einspeisung Anfang seitlich / Feed beginning from the side
	 L-Verbinder / L-Connector
	 L-Verbinder / L-Connector
	 X,T-Verbinder / X,T-Connector
	 X,T-Verbinder / X,T-Connector



Selbsttest / Automatic Test

Funktionsanzeige LED / Indicator LED

	- Grün Dauer / green continuously	- Netz vorhanden, Ladung OK / mains available, charging OK
	- Aus / off	- Netz fehlt, defekte Notlichtelektronik / no mains available, faulty electronic
	- Rot blinkend / red flashing (1Hz)	- Leuchtmittelfehler / lamp source failure
	- Rot Dauer / red continuously	- Akkufehler / battery failure
	- Abwechselnd Rot-Grün / red-green flashing	- Testbetrieb / test mode

Kontrolle nach der Installation

30 Minuten nach der Inbetriebnahme muss die Status-LED grün leuchten. Wenn die LED nicht leuchtet, ist die Ladung durch fehlende Netzspannung, unterbrochene Leitung zum Akku oder defekte Ladeeinheit nicht gewährleistet.

Selbsttest

Alle Leuchten der Baureihe enthalten ein automatisches Testsystem und überprüfen sich eigenständig. Bei den Leuchten wird wöchentl. die Einsatzbereitschaft der Elektronik, der Lampe und des Akkus geprüft. Zusätzlich wird jährl. die Kapazität des Akkus durch Simulation des Netzausfalls gemessen. Der erste Kapazitätstest erfolgt 8 Tage nach der Installation oder einer Fehlerbehebung. Nach dem Selbsttest muss die Status LED kontrolliert werden.

Prüfungen

Einzelbatterieleuchten sind gemäß der Vorschriften am Montageort zu testen. Mängel sind sofort zu beheben. Prüfergebnisse sind im Prüfbuch zu dokumentieren.

Quittieren

Wenn beim Test Fehler auftreten, werden diese durch die farbige Status LED an der Leuchte angezeigt. Um die Fehleranzeige nach Behebung des Fehlers zurückzusetzen, muss die Versorgungsspannung der Leuchte kurzfristig abgeschaltet werden.

Check after installation

30 minutes after start up must the green LED on. If the LED is off, it must be detected that the charging is not inhibited due to a missing voltage supply, due to a line interruption to the battery or due to a faulty electronic.

Automatic Test

All luminaires of this series are assembled with an automatic self test system, testing the luminaires independently. Weekly tested are the electronic system, the lamp and the battery. Additionally, every year the battery capacity is measured by simulating a mains power failure. The first capacity test is performed 8 days after installation or fault repair. The indicator LED must be checked after the first self-test.

Tests

Self-contained luminaires had to tested at their mounting location in compliance with the regulations. Any defects have to be repaired immediately. Test results need to noted.

Acknowledging error status

If failure will displayed, these are indicated by colored status LED on luminaire. Reset the error status after testing, the luminaire has to be disconnected from mains voltage temporarily.

Verdrahtungsplan / wiring diagram

Notlichtkreis 1
emergency circuit 1

N	L	①
2	1	

oder / or –

Notlichtkreis 2
emergency circuit 2

N	L	②
7	6	

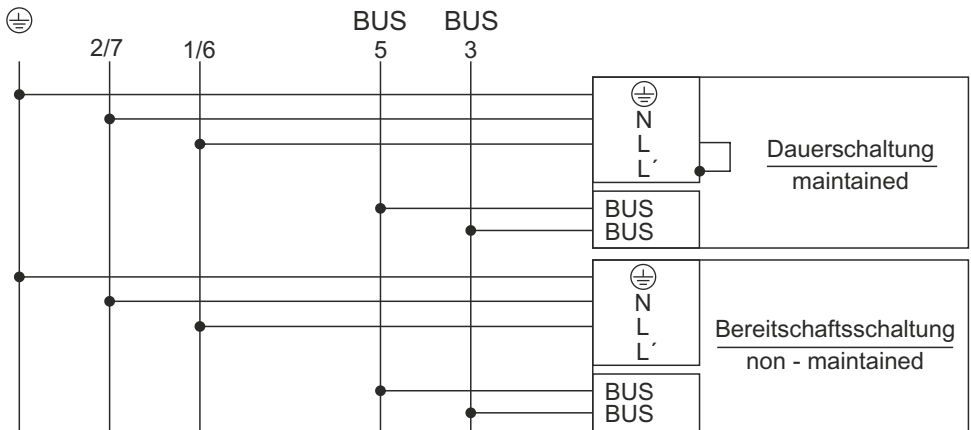

Verdrahtung / wiring		I max.	7x	14x
L1	Phase 1 /phase 1	16 A		
L2	Phase 2 /phase 2	16 A		
L3	Phase 3 /phase 3	16 A		
	Schutzleiter / Protective conductor			
N	Neutralleiter /Neutral conductor			
D1	DALI DA /DALI DA			
D2	DALI DA /DALI DA			
1	Notbeleuchtung Kreis 1 /emergency lighting circle 1 (L / L+)	6 A		
2	Notbeleuchtung Kreis 1 /emergency lighting circle 1 (N / N/-)	6 A		
3	Steuer oder geschaltetes Signal / Control or switched signal L (SE)	6 A		
4	Schutzleiter / Protective conductor			
5	Steuer oder geschaltetes Signal / Control or switched signal N (SE)	6 A		
6	Notbeleuchtung Kreis 2 /emergency lighting circle 2 (L / L+)	6 A		
7	Notbeleuchtung Kreis 2 /emergency lighting circle 2 (N / N/-)	6 A		

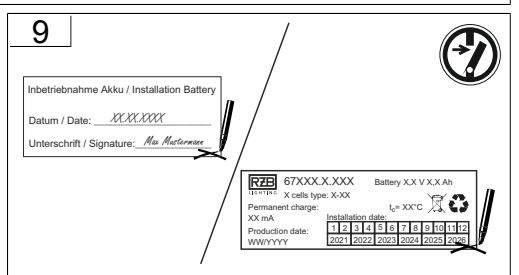
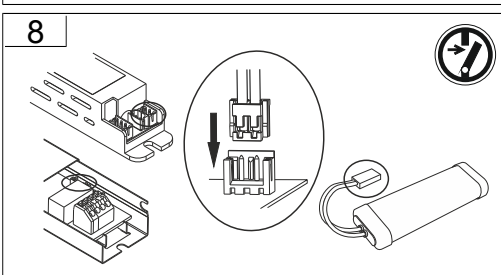
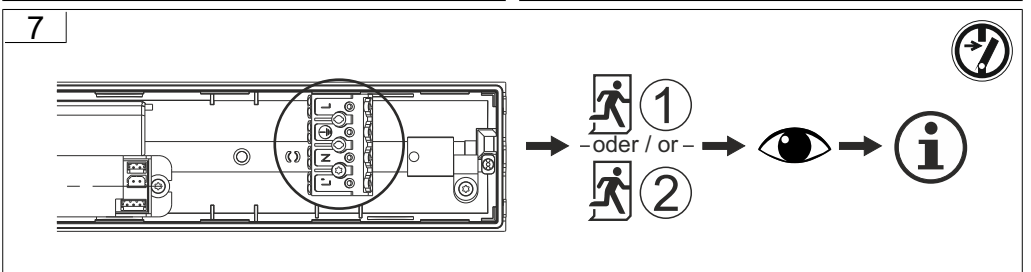
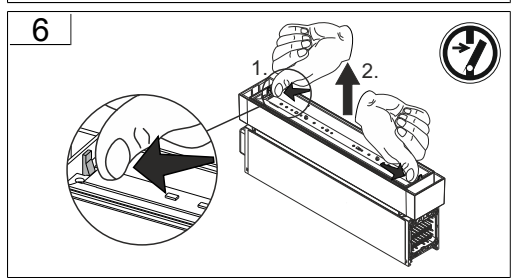
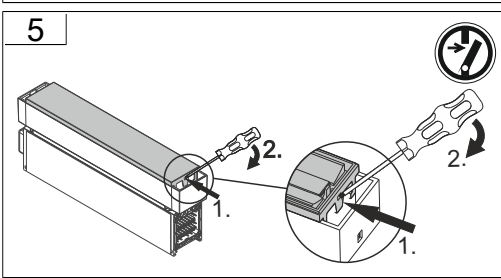
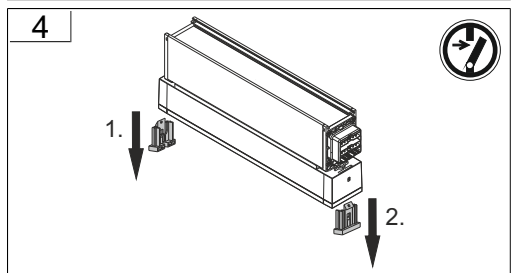
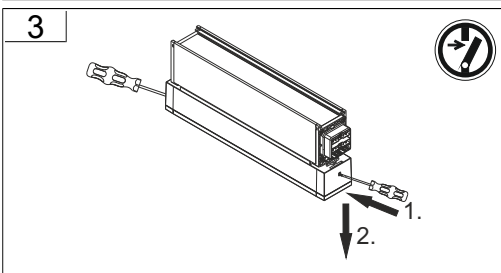
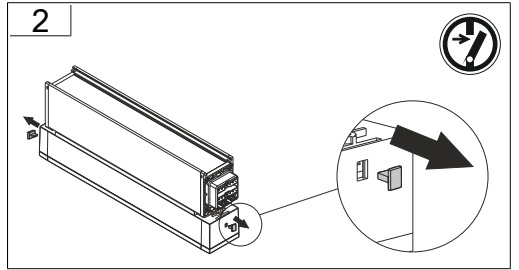
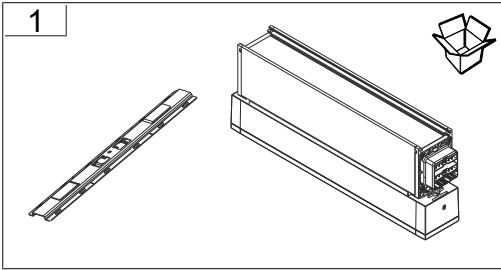
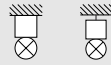

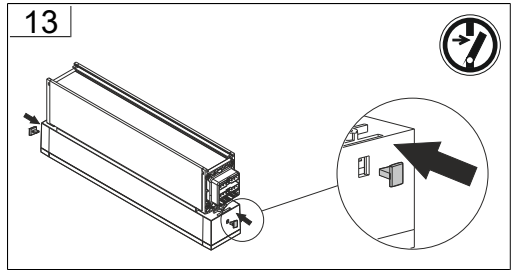
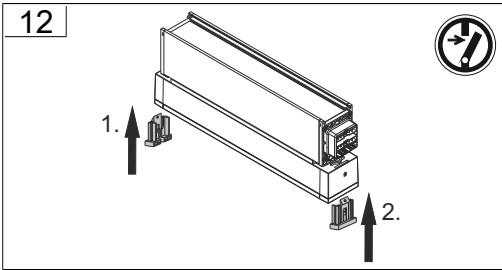
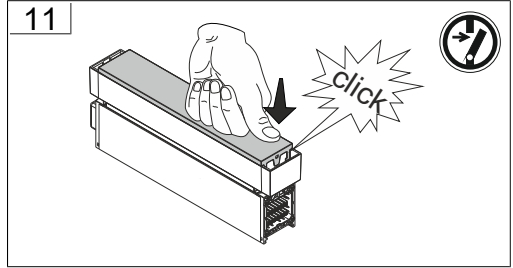
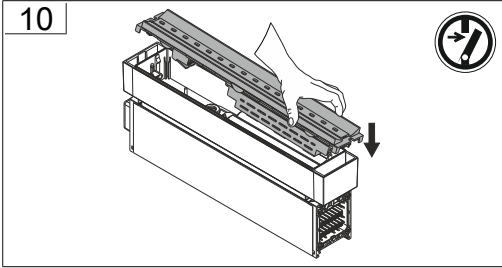
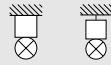

14a

	L	X*
4547 mm	≤ 4500 mm	≤ 60000 mm
2291 mm	≤ 2270 mm	≤ 50000 mm

* $R_{PE} < 0,5 \Omega$
EN 60598

14b

	L	X*
4547 mm	≤ 4500 mm	≤ 60000 mm
2291 mm	≤ 2270 mm	≤ 50000 mm

* $R_{PE} < 0,5 \Omega$
EN 60598

14c

$< 2291 \text{ mm} \geq 1x$

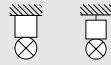

14d

	L	X*
4547 mm	≤ 4400 mm	≤ 60000 mm
2291 mm	≤ 2100 mm	≤ 50000 mm

* $R_{PE} < 0,5 \Omega$
EN 60598

14e

	L	X*
4547 mm	≤ 4400 mm	≤ 60000 mm
2291 mm	≤ 2100 mm	≤ 50000 mm

* $R_{PE} < 0,5 \Omega$
EN 60598

14f

	L	X*
4547 mm	≤ 4400 mm	≤ 60000 mm
2291 mm	≤ 2100 mm	≤ 50000 mm

* $R_{PE} < 0,5 \Omega$
EN 60598

14g

$\geq 2291 \text{ mm} \geq 2x$ ✓
 $< 2291 \text{ mm} \geq 1x$ ✓

15



16

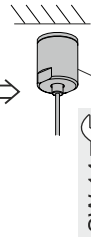
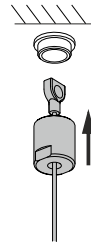
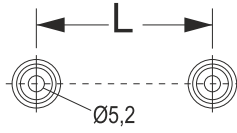
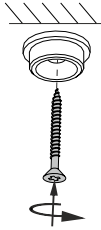
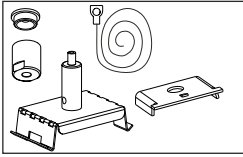

17

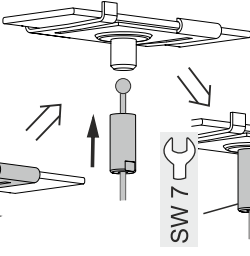
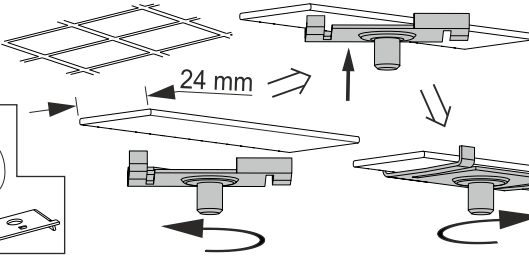
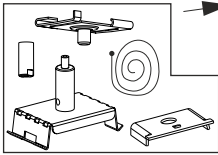

18a

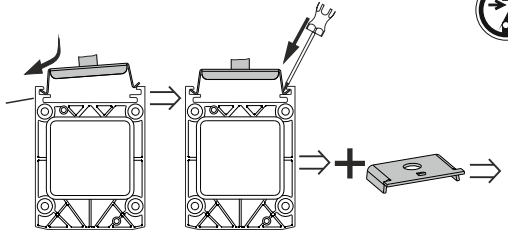
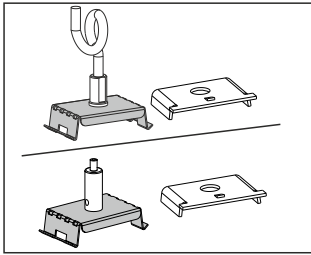

18b

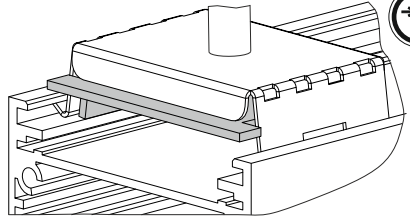
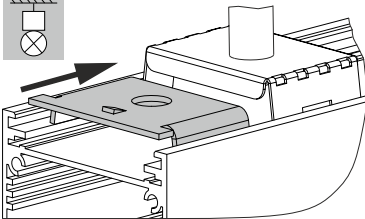

19

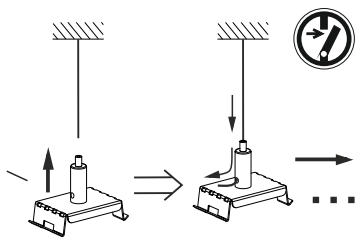
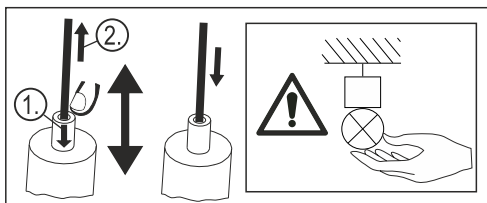
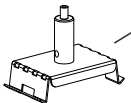

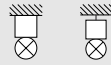

20

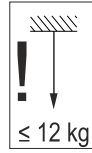
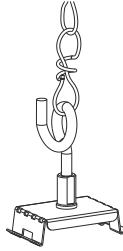
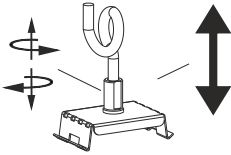

21a

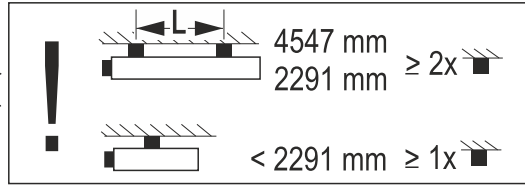
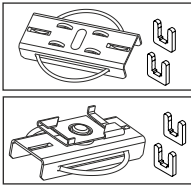

21b

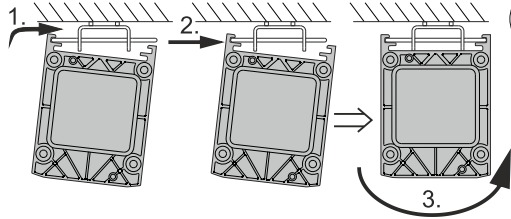
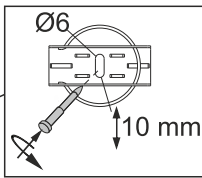
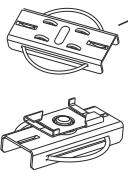

21c

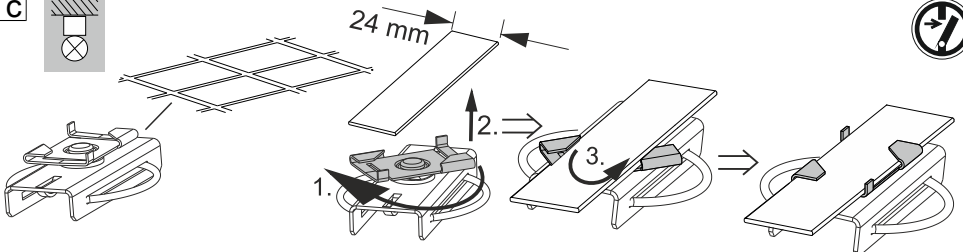

21d

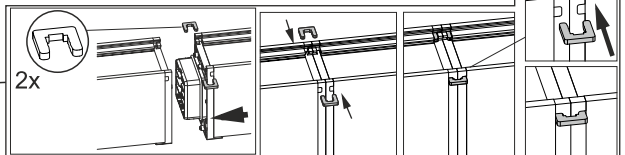
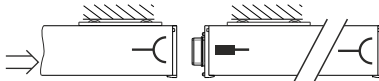
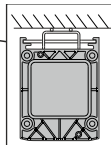
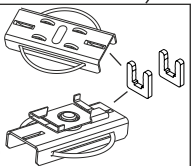

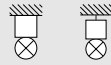

22a

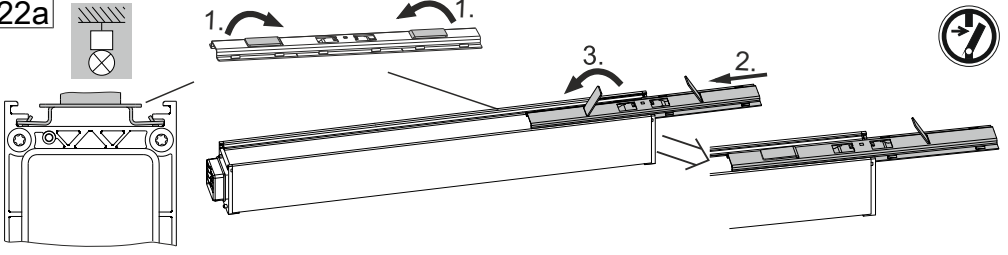

22b

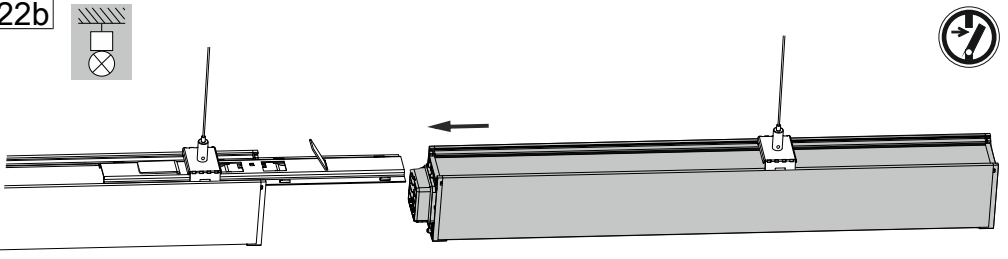

22c

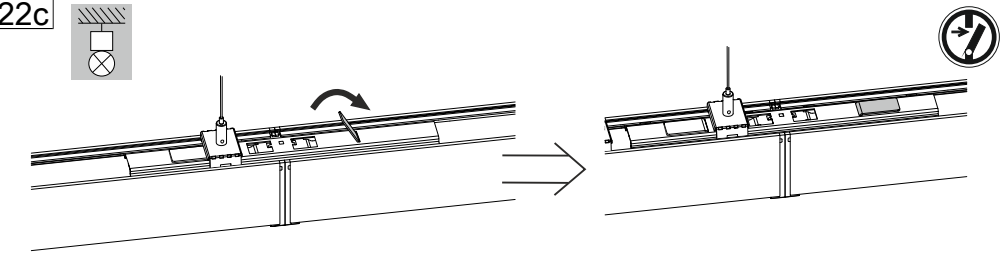

23

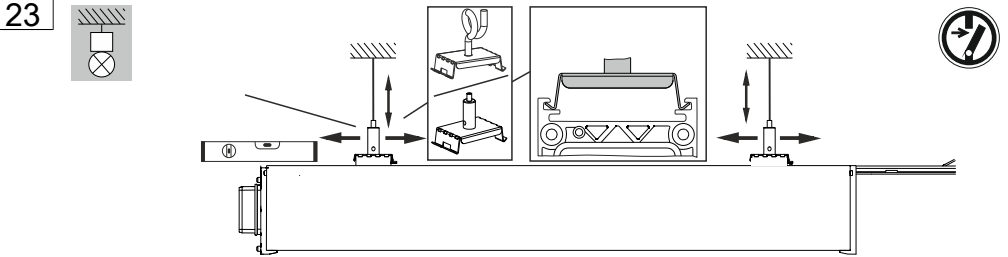

24a

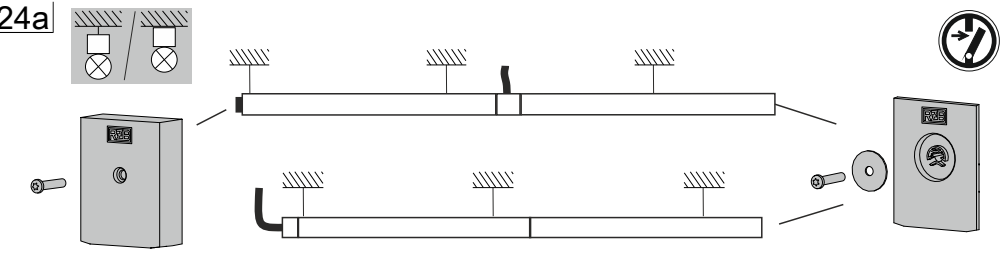

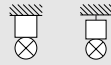

24b

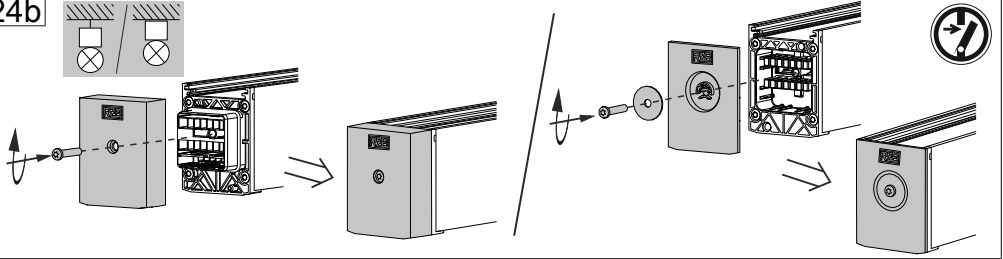

25

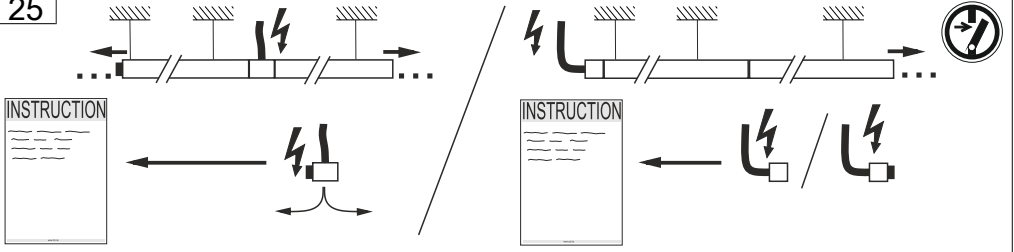

26

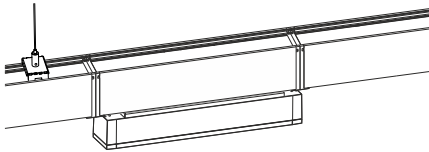

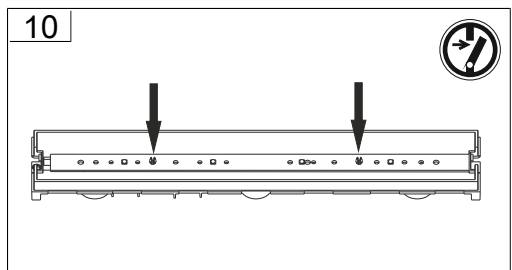
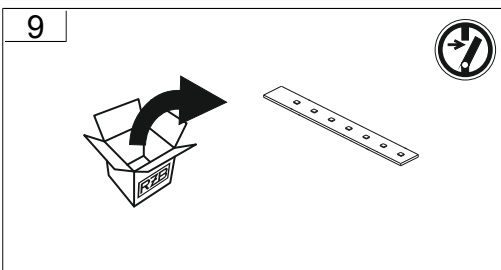
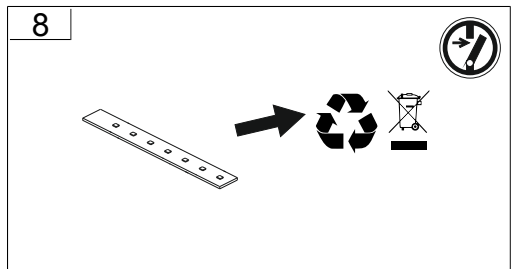
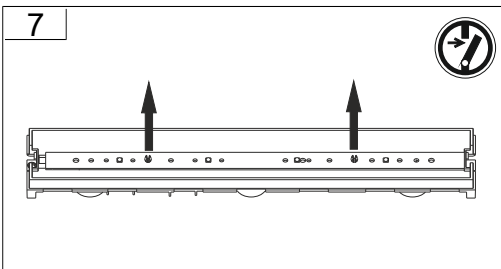
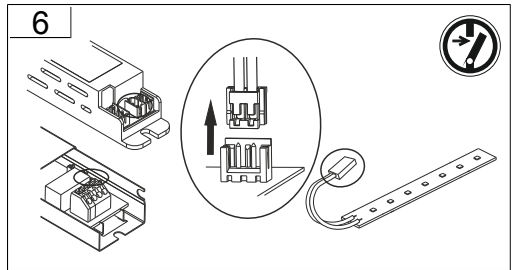
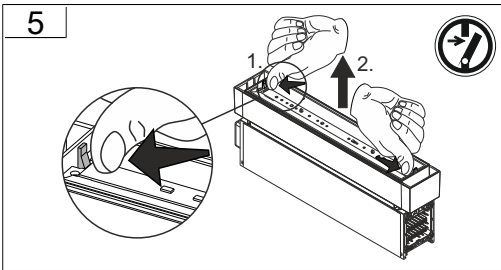
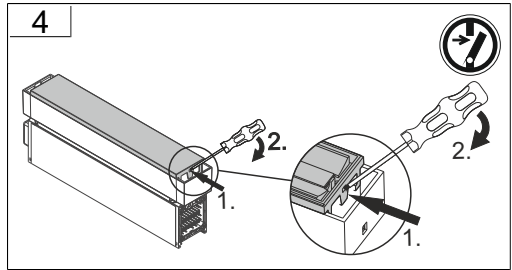
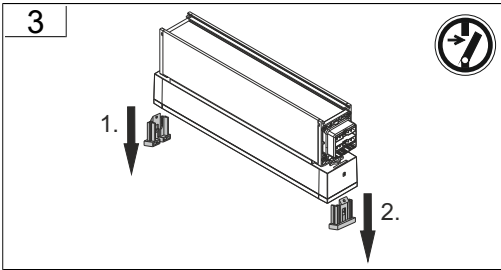
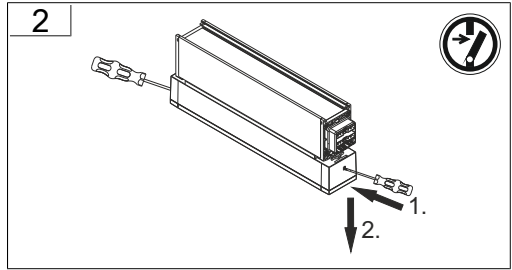
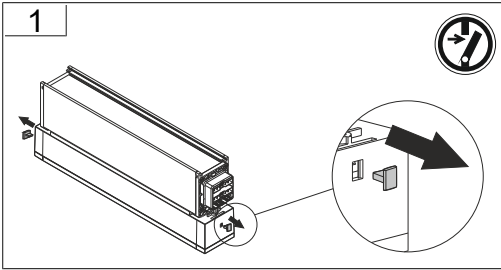

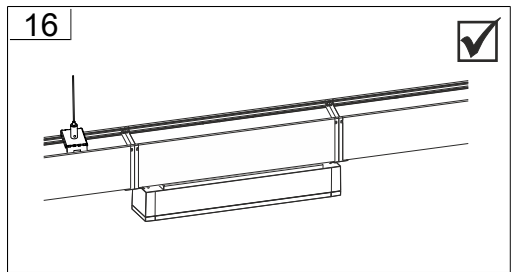
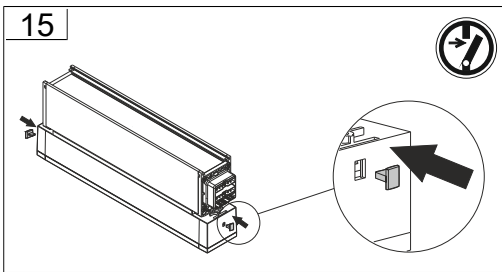
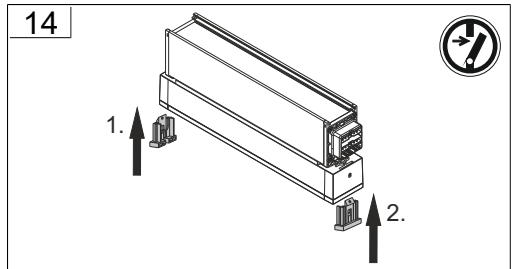
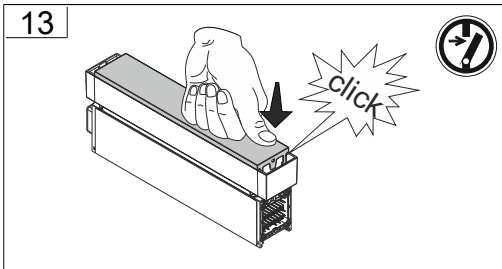
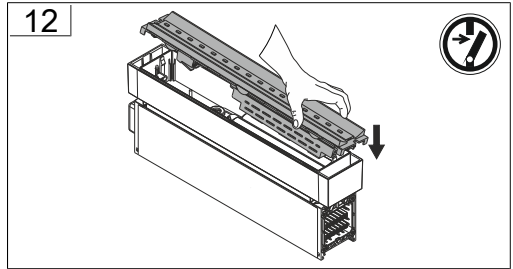
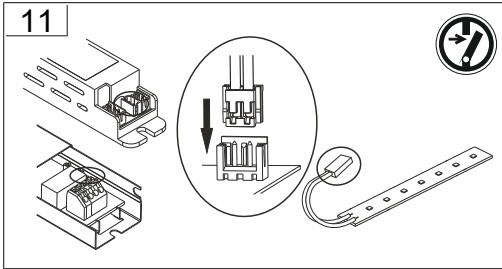

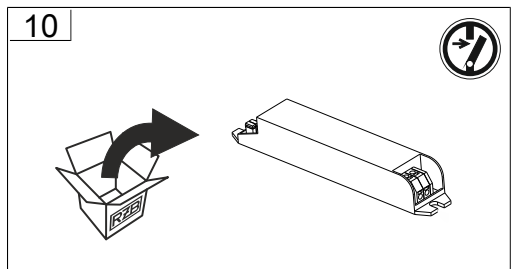
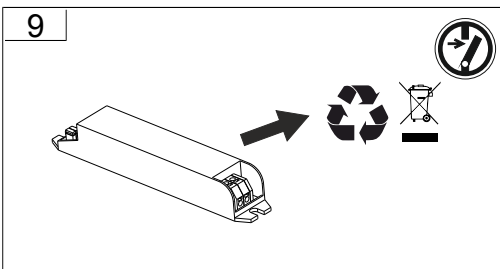
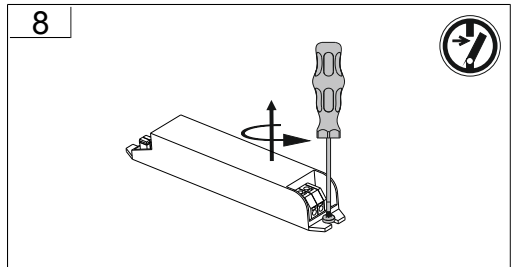
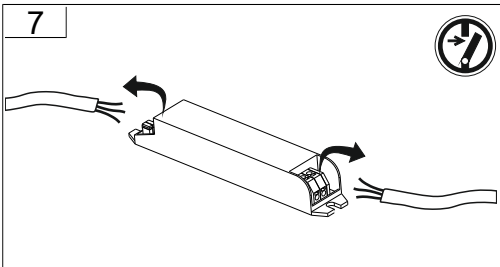
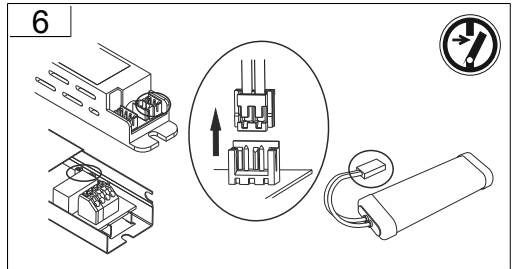
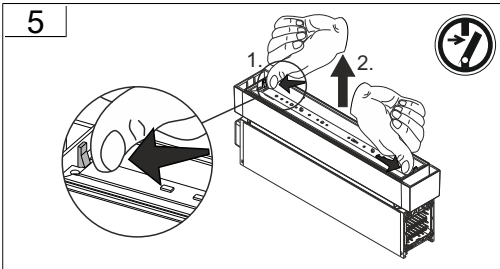
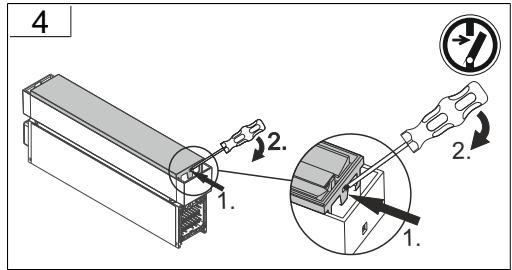
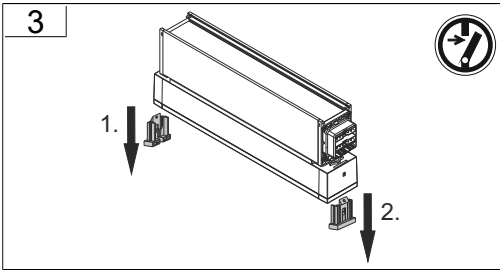
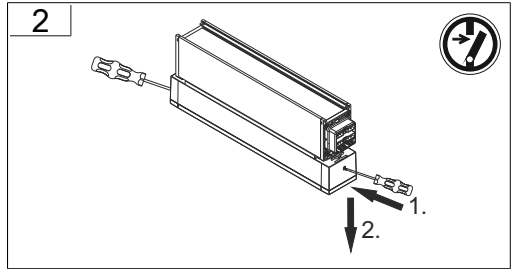
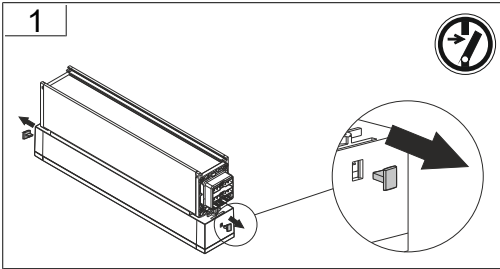

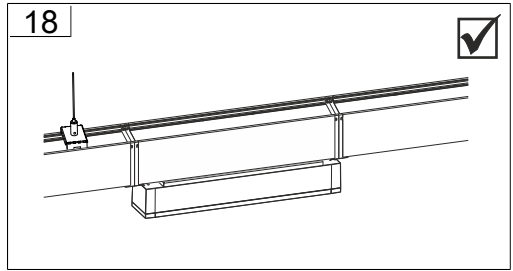
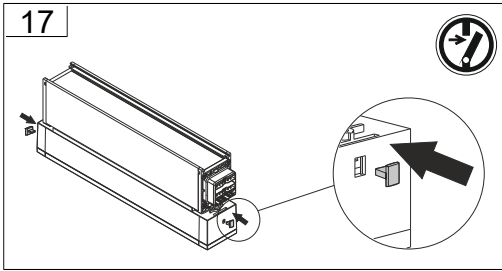
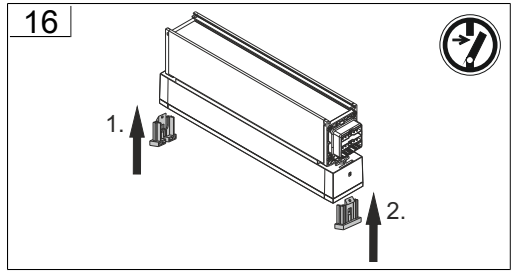
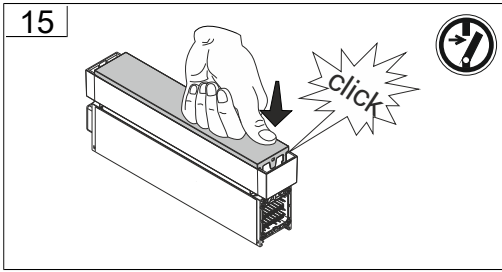
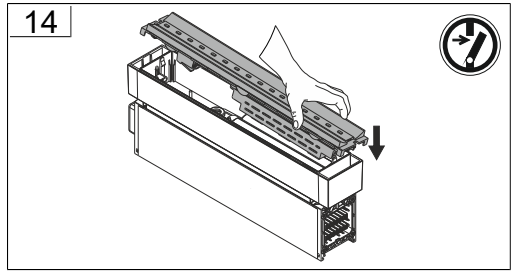
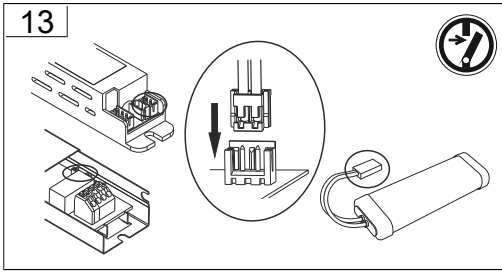
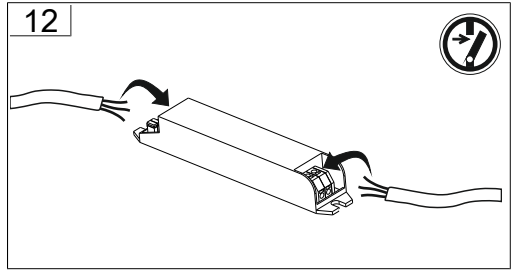
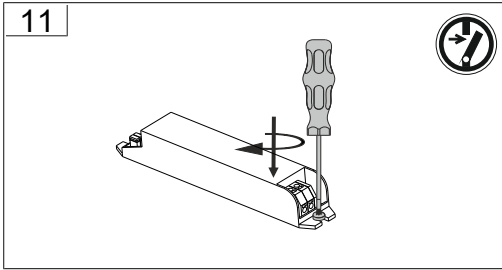

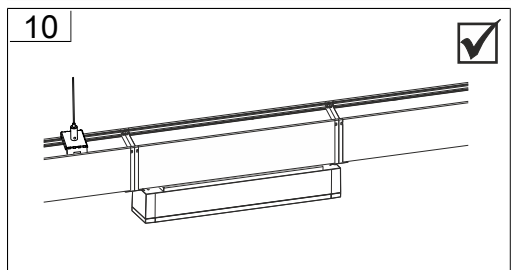
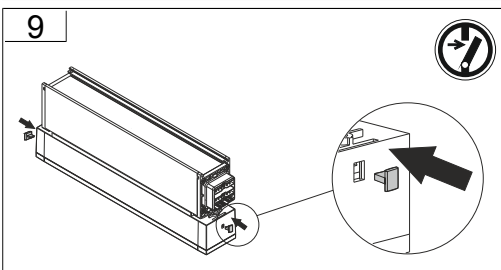
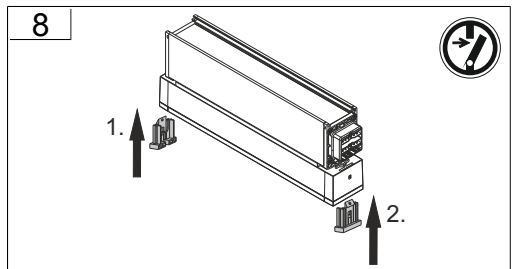
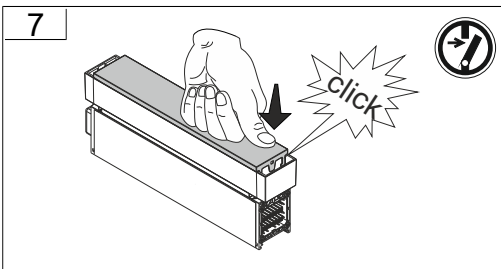
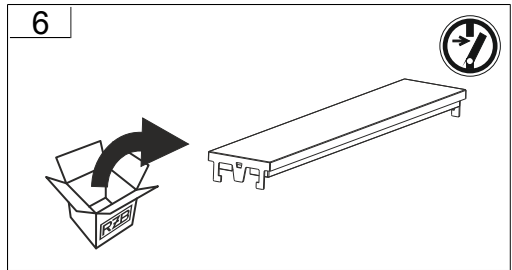
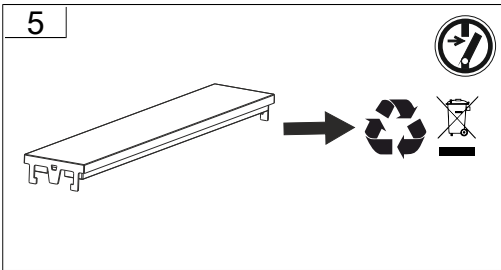
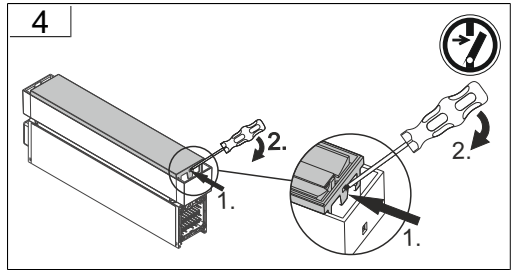
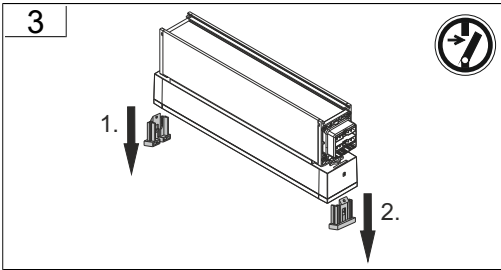
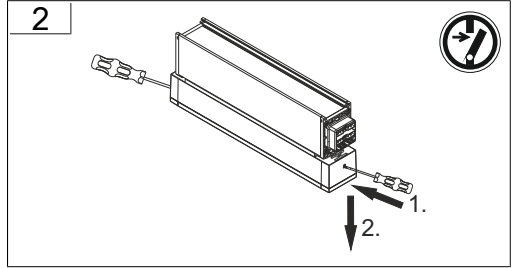
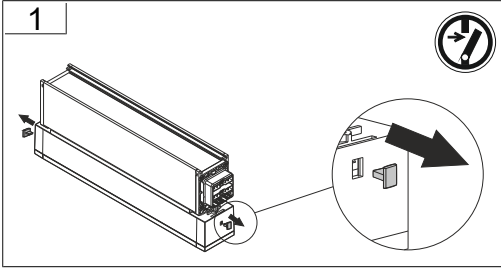

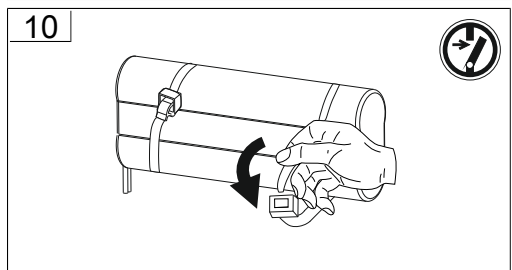
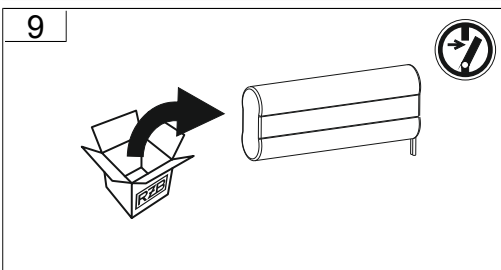
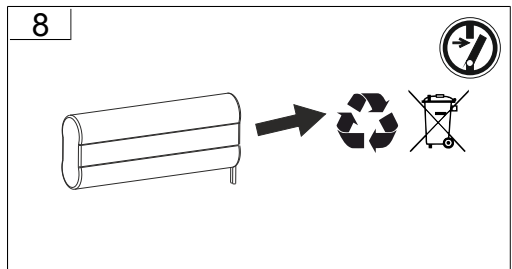
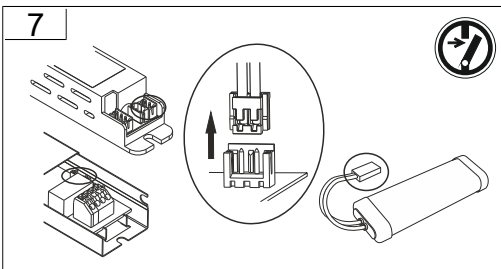
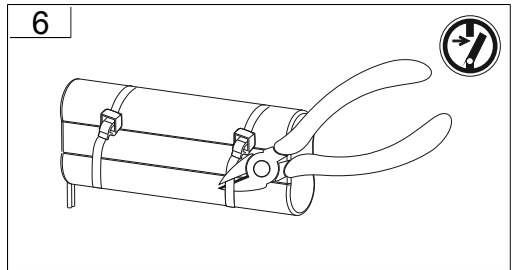
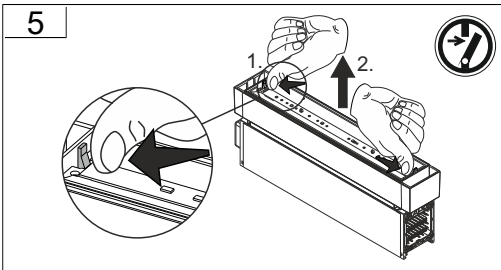
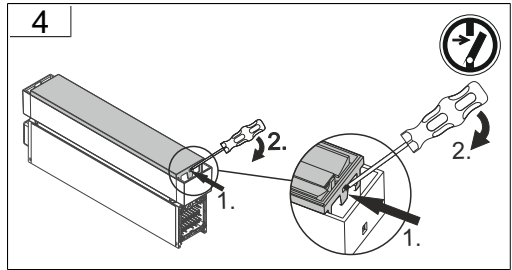
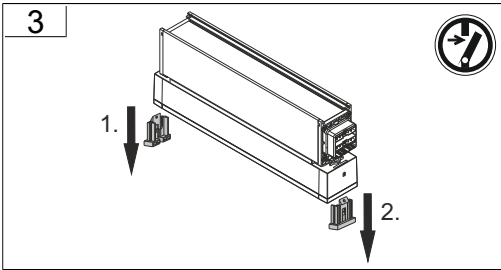
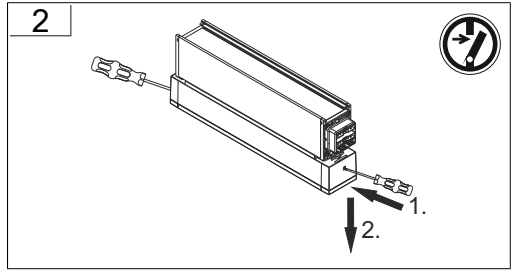
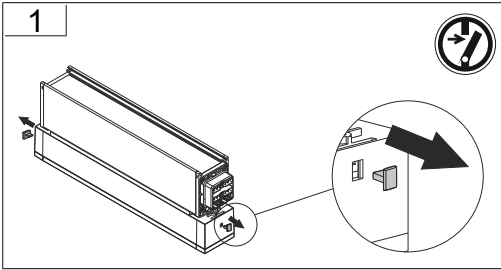
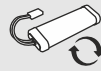

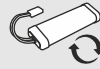

11

12

Inbetriebnahme Akku / Installation Battery

Datum / Date: XX.XX.XXXX

Unterschrift / Signature: Ma. Matrone

RZB	67XXX.X.XXX	Battery XX V XX Ah
TRITEC	X cells type: X-XX	°C
Permanent charge:	XX mA	Installation date: 2021 2022 2023 2024 2025 2026
Production date:	2021 2022 2023 2024 2025 2026	WWYYYY

13

14

15

16

17

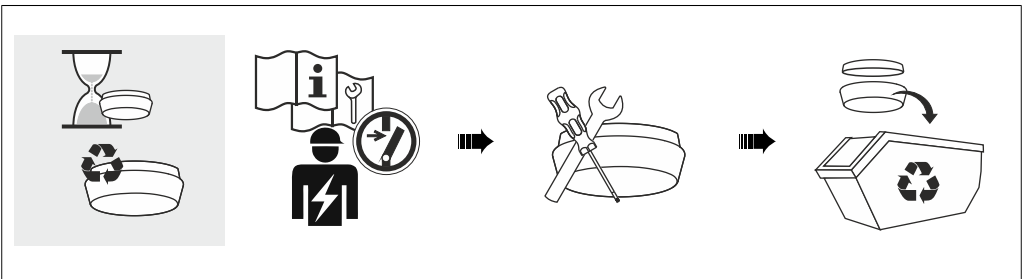
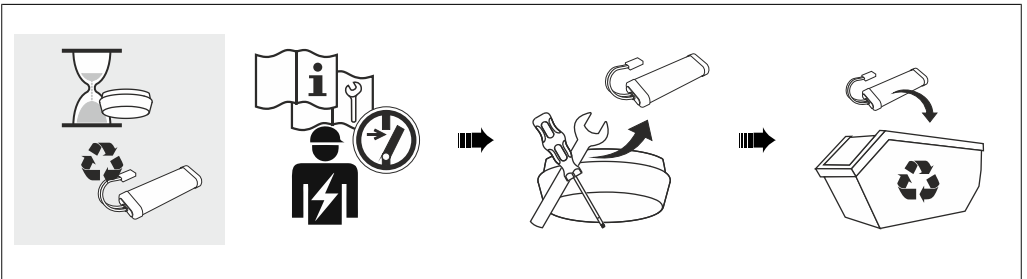
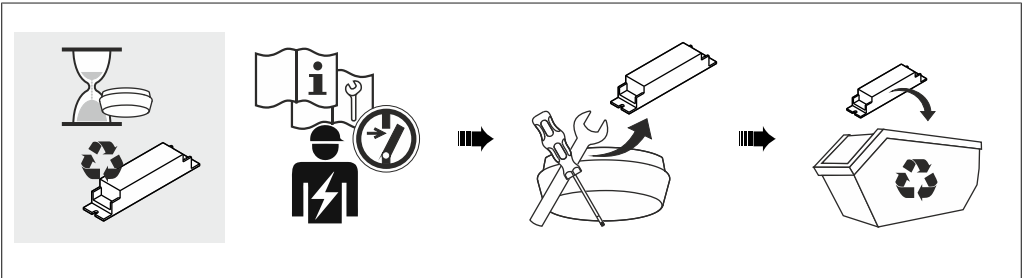
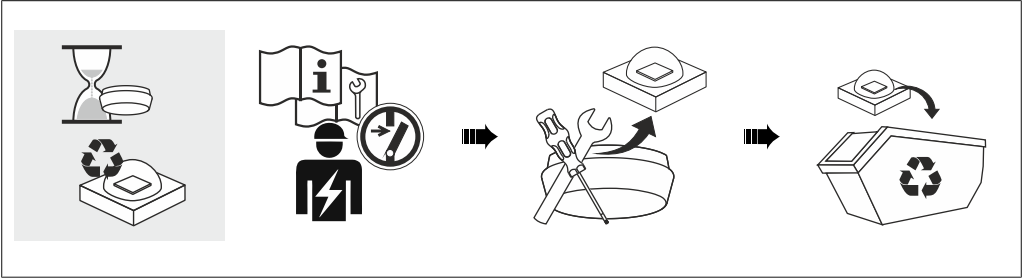

RZB - Rudolf Zimmermann, Bamberg GmbH

 Rheinstraße 16, 96052 Bamberg

 0951/7909-0

 0951/7909-198

 info@rzb-leuchten.de