

# INSTRUCTION

Planox  
672918.009.24

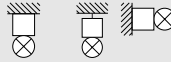

≈ 220 - 240 V 0 Hz, 50/60 Hz IP 66 IK08

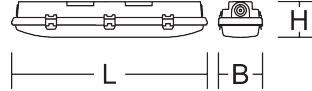
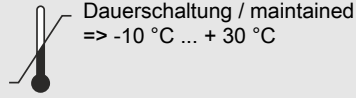

L 1454, B 102, H 81



2,4 kg

	$\Phi$ [lm]	$P_{\text{LED}}$ [W]	$\Phi$ [lm]	$P_{\text{LED}}$ [W]	$P_{\text{LED}}$
--	-------------	----------------------	-------------	----------------------	------------------

LED 7700 47 810 8 1 x 50,8 W

CCT [K]	CRI	RG	EEK		
---------	-----	----	-----	--	--

4000 80 RG 0 C

$I_{\text{max}}$ / $I_{\text{max}}/2$ [T50]	B10 [St.]	B16 [St.]	C10 [St.]	C16 [St.]	$\cos \varphi$
---	-----------	-----------	-----------	-----------	----------------

37 A / 147  $\mu$ s 17 28 29 47 0,95

$f_{\text{min}} - f_{\text{max}}$ [MHz]	$p_{\text{EIRP}}$ [mW]	
---	------------------------	--

13,553 – 13,567 0

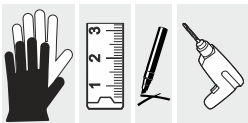



Installation erfordert  
Elektro-Fachkraft!

Symbole nach ISO 7010



### Allgemeine Sicherheitshinweise

- Der elektrische Anschluss muss ordnungsgemäß nach geltenden Normen und den nationalen sowie internationalen Sicherheits- und Unfallverhütungsvorschriften erfolgen.
- Beschädigte Leuchten dürfen nicht betrieben werden.
- Keine Haftung für Schäden durch unsachgemäßen Einsatz.
- Bei Instandsetzung nur Originalteile verwenden.
- Tragfähigkeit der Decke und Befestigungselemente sicherstellen.

### Betrieb der Leuchte

- Die unzulässigen Umgebungstemperaturen reduzieren die Lebensdauer der Leuchte, im Extremfall droht der Frühausfall.
- Zur Vermeidung von EMV-Problemen die Durchgangsverdrahtung nicht entlang der Leuchtenverdrahtung führen.
- Steuereingänge von dimmbaren Leuchten mit handelsüblichen für Netzspannung geeigneten Leitungen anschließen.

### Manipulationen unserer Produkte sind unzulässig

Veränderung, Umarbeitung, Umkennzeichnung von Produkten sowie deren Verpackung sind unzulässig und verletzen u.a. unsere eingetragenen Warenzeichenrechte. Solche Modifikationen können technische Eigenschaften unserer Produkte negativ beeinflussen, diese zerstören und möglicherweise Folgeschäden an anderen Objekten verursachen. Für durch derartige Modifikationen verursachte Schäden kann der Hersteller in keinem Fall verantwortlich gemacht werden.



Installation requires  
a qualified electrician!

Symbols according  
to ISO 7010



### General Safety Information

- Electric connection must be appropriate according to all applicable standards and other national and international safety and accident prevention regulations.
- Damaged luminaires must not be operated.
- No liability is accepted for damages resulting from improper use.
- Use genuine parts only for repair.
- Ensure stability of the ceiling and fastening elements.

### Operation of the luminaire

- Exceeding the permissible ambient temperature will reduce the luminaire's lifecycle, resulting in premature failure in extreme cases.
- Avoid ESD problems by not routing feed-through wiring directly along the wiring of the luminaire.
- Connect control inputs of dimmable luminaires with standard cables suitable for power supply voltage.

### Manipulation of our products is not permitted

Modifications, reworking, re-labelling of products as well as their package is not permitted and infringes, amongst others, our registered trademark rights. Such modifications may affect technical properties of our products, damage them and possibly cause consequential damage to other objects. The manufacturer shall not be responsible under any circumstances for damage caused by such modifications.



 Bei Fragen zu unseren Symbolen, besuchen Sie folgende Webseite:  
If you have any questions about our signs, visit the following website:



[https://www.rzb.de/fileadmin/assets/downloads/PDF/RZB\\_Symbolklaerung.pdf](https://www.rzb.de/fileadmin/assets/downloads/PDF/RZB_Symbolklaerung.pdf)

**EEK** 

Dieses Produkt enthält eine Lichtquelle der Energieeffizienzklasse C entsprechend Verordnung (EU) 2019/2015

This product contains a light source of energy efficiency class C according to regulation (EU) No 2019/2015

 Jede zersprungene Schutzabdeckung ist zu ersetzen. DIN EN 60598

Replace any cracked protective shield. IEC DIN EN 60598

 Die Lichtquelle dieser Leuchte darf nur vom Hersteller oder einem von ihm beauftragten Servicetechniker oder einer vergleichbar qualifizierten Person ersetzt werden. DIN EN 60598-1 / IEC 60598-1

The light source contained in this luminaire shall only be replaced by the manufacturer or his service agent or a similar qualified person. DIN EN 60598-1 / IEC 60598-1

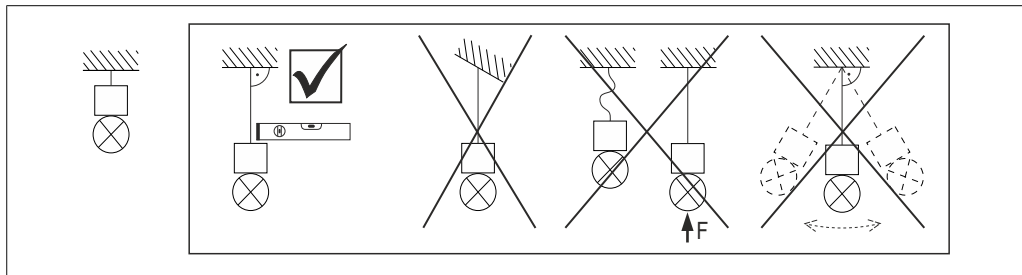

Zur Verwendung in Anlagen nach EN 50172 / DIN VDE 0108-100

For installation according to EN-50172 / DIN VDE 0108-100



### Einteilung Notleuchten

*	**	***	****
---	----	-----	------

Veränderungen am Auslieferungszustand der Leuchte sind gemäß DIN EN 60598-2-22 auf dem Typenschild zu kennzeichnen.

### Classification Emergency Lighting

*	**	***	****
---	----	-----	------

Modifications to the delivery condition of the luminaire must be documented on the product label accordingly to IEC 60598-2-22.

*	Typ (1-stellig)	Type (1-digit)
X	Einzelbatterie	Self-Contained
Z	Zentralbatterie	Central Supply

**	Betriebsart (1-stellig)	Operating Mode (1-digit)
0	Notleuchte Bereitschaftsschaltung	Emergency Lighting non-maintained
1	Notleuchte Dauerschaltung	Emergency Lighting maintained
2	Kombinierte Notleuchte Bereitschaftssch.	Combi. Emergency Lighting non-maintained
3	Kombinierte Notleuchte Dauerschaltung	Combined Emergency Lighting maintained

***	Einrichtungen (max. 7-stellig)	Installation (max. 7-digit)
A	manuelle Prüfeinrichtung	Manual Test Device
B	Fernschalter für Ruhe-Zustand	Including Remote Rest Mode
C	Fernausschaltemöglichkeit	Including Inhibiting Mode
D	Arbeitsstätten m. besonderer Gefährdung	High-Risk Task-Area Luminaire
E	Lampe oder Batterie nicht austauschbar	With non-replaceable Lamps or Battery
F	automatische Prüfeinrichtung	Automatic Test Device
G	von innen beleuchtetes Sicherheitszeich.	Inside illuminated safety sign

****	Betriebsdauer (2/3-stellig) (nur bei Einzelbatterie)	Duration Time (2/3-digit) (only for self-contained)
60	Betriebsdauer 60 Minuten	Duration Time 60 Minutes
180	Betriebsdauer 180 Minuten	Duration Time 180 Minutes
480	Betriebsdauer 480 Minuten	Duration Time 480 Minutes



Anschlussplan / Wiring diagram

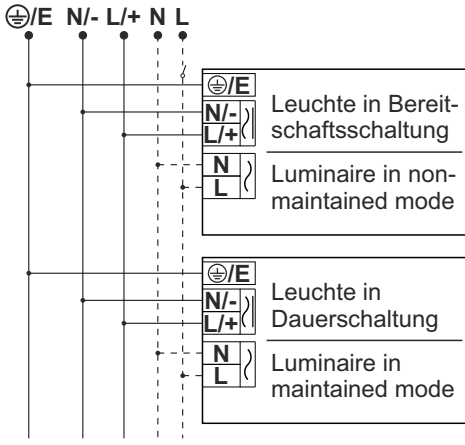

	⊕/E	Schutzleiter (SK I) // Ground Wire (IC I)
<b>E</b>		Erdung (SK II) // earthing (IC II)
<b>N/-</b>		Nullleiter, negativer Pol Neutral Wire, negative Pole
<b>L/+</b>		Dauerphase, positiver Pol Duration Wire, positive Pole
<b>N</b>		Schalteingang Switch Input
<b>L</b>		
	<b>Dauerschaltung</b> Maintained	<b>Bereitschaftsschaltung</b> non-maintained

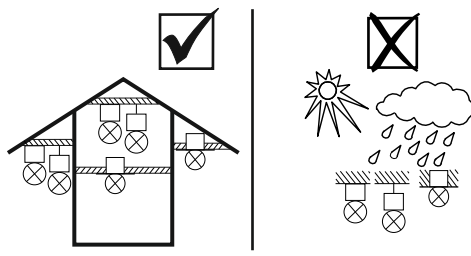
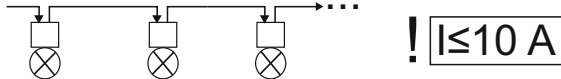

## Anschlussplan / Wiring diagram

### ELUSWITCH 981352.002

Umschaltweiche / Monitoring module

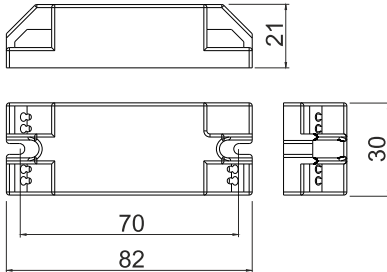

### Technische Daten / Technical Data:

Gehäuse / Housing:

Eingangsspannung / Voltage:

Umgebungstemperatur / Ambient temperature:

Schaltleistung / Connectable Load:

Kunststoff, weiß / Plastic, white

230V AC ( $\pm 10\%$ )

220V DC ( $\pm 20\%$ )

-10 ... 60 °C

250VA

### Allgemeinbeleuchtung

#### General lighting

**Lichtschalter** 230V

**Lightswitch** 50/60Hz

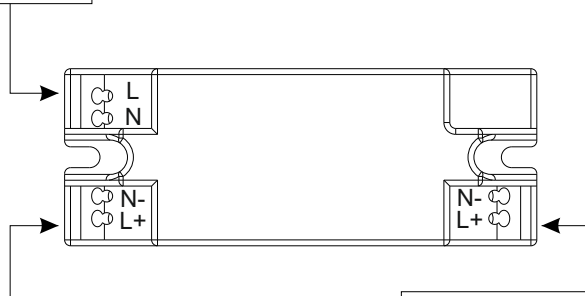

### Sicherheitsstromversorgung emergency batterie

#### Bereitschaftsschaltung

**CPS NON-Maintained**

aus der ZBA 230V AC/DC

from CPS 230V AC/DC

**Verbraucher 250VA**  
**Load 250 VA**



**EU-Konformitätserklärung**  
**EU Declaration of Conformity**  
**Déclaration UE de conformité**  
**Declaración UE de conformidad**  
**Deklaracja zgodności UE**



**Hersteller, Anschrift:**  
**Manufacturer, address:**  
**Fabricant, adresse:**  
**Fabricante, dirección:**  
**Producent, adres:**

**RZB Rudolf Zimmermann, Bamberg GmbH**  
**Rheinstrasse 16**  
**96052 Bamberg**  
**Deutschland / Germany / Allemagne / Alemania / Niemcy**

Wir erklären in alleiniger Verantwortung, dass das Produkt  
*We declare under sole responsibility that the product*  
*Nous déclarons, sous notre propre responsabilité, que le produit*  
*Declaramos bajo nuestra sola responsabilidad que el producto*  
*Deklarujemy z pełną odpowiedzialnością, że produkt*

**Produktbezeichnung:**  
**Product designation:** **Planox**  
**Description des produits:**  
**Designación de producto:** **672918.009.24**  
**Oznaczenie produktu:**

mit den folgenden EU-Richtlinien und Normen übereinstimmt:  
*complies with the following EU Directives and standards:*  
 est conforme aux normes et directives de l'UE suivantes:  
 cumple con las siguientes directivas y normas CE:  
 jest zgodny z następującymi dyrektywami UE i normami:

<p><b>RED Directive</b> 2014/53/EU</p>	<p><b>(3.1a)</b>          EN 60598-2-1:1989          EN 60598-2-1:2021          EN 60598-2-22:2014 + A1:2020          EN 62471:2008          EN 62493:2010          EN 62493:2015 + A1:2022          EN IEC 60598-1:2021 + A11:2022          EN IEC 60598-1:2024 + A11:2024  <b>(3.1b)</b>          EN 61000-3-2:2014          EN 61000-3-3:2013 + A1:2019 + A2:2021 + A2:2021/AC:2022-01          EN 61547:2009          EN IEC 55015:2019 + A11:2020          EN IEC 61000-3-2:2019 + A1:2021 + A2:2024          EN IEC 61547:2023  <b>(3.2)</b>          EN 300 330 V2.1.1</p>
<p><b>RoHS Directive</b> 2011/65/EU + (EU) 2015/863</p>	<p>EN IEC 63000:2018</p>
<p><b>ErP Directive</b> 2009/125/EC</p>	<p>(EU) 2019/2020 (EU) 2021/341</p>

Dokument-Nr. / Document No. / Document No.  
 Document No. / Nr dokumentu

**26000094**

Aussteller / Issuer / Délivré par:  
 Otorgante / Wystawca:

**RZB Rudolf Zimmermann, Bamberg GmbH**

Ort, Datum / Place, Date / Lieu, date:  
 Lugar, Fecha / Miejsce, data:

**Bamberg, den 07.01.2026**

Rechtsverbindliche Unterschrift:  
 Legally binding signature:  
 Signature juridiquement obligatore:  
 Firma legalmente vinculante:  
 Prawnie wiązacy podpis:

  
 Reiner Jürgens  
 CEO/Direktor Zarządzający/Geschäftsführer

1/1

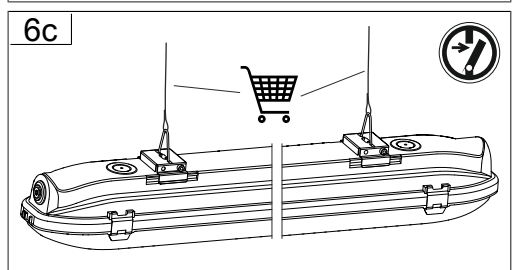
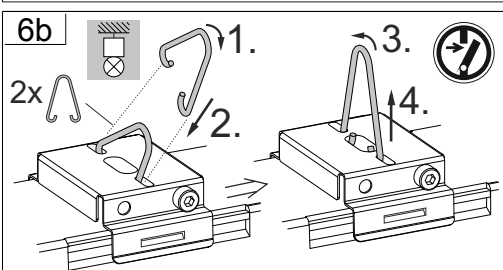
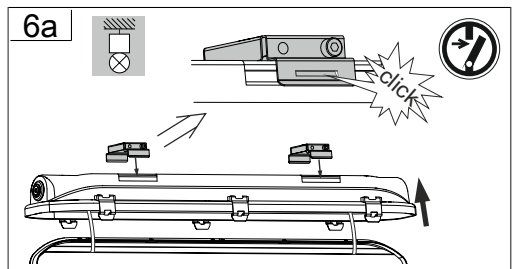
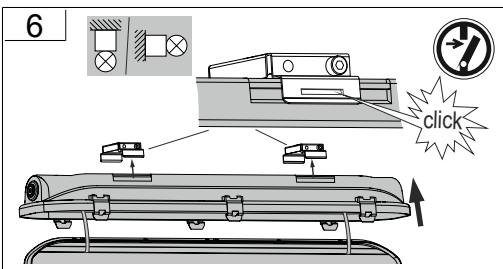
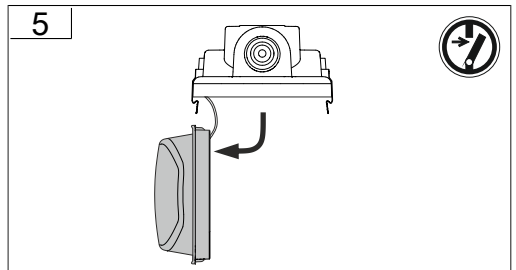
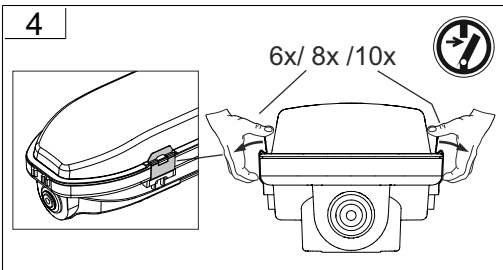
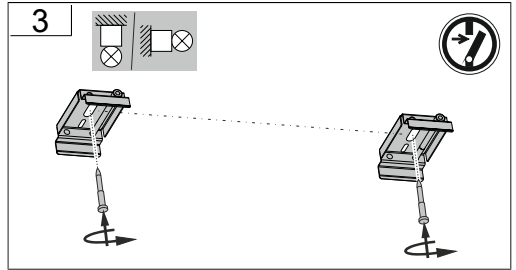
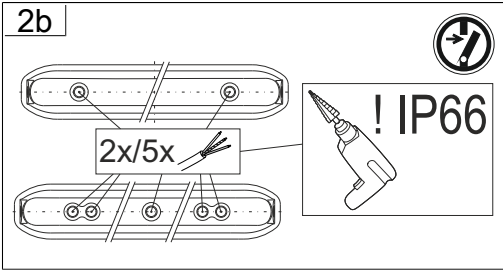
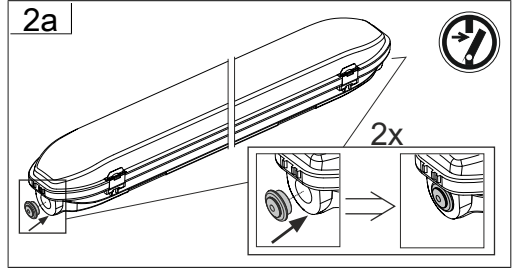
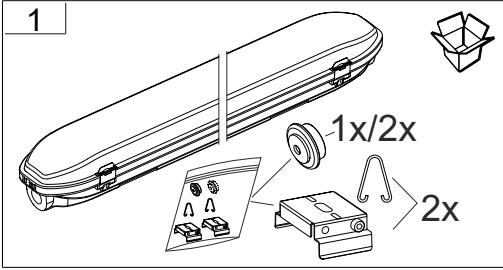

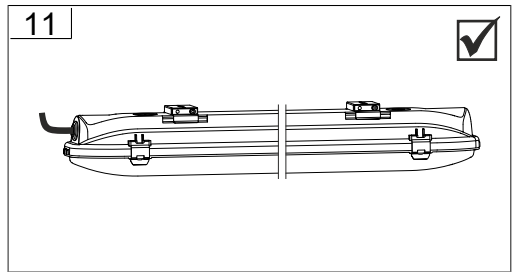
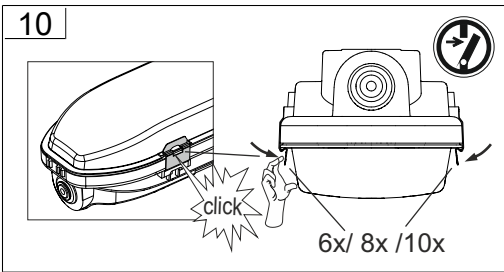
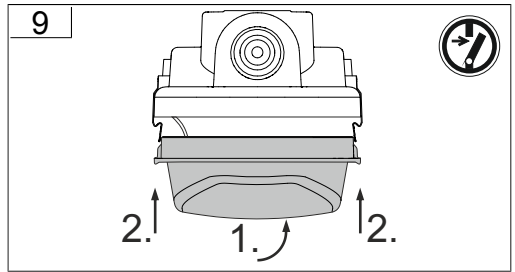
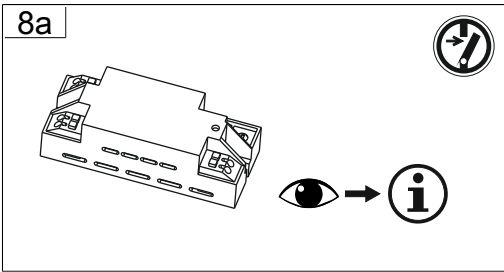
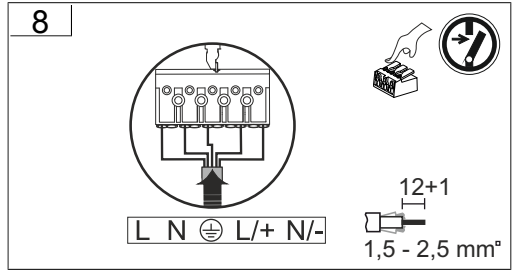
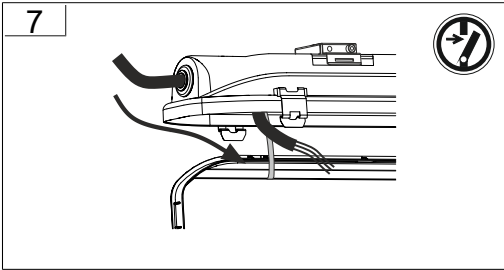
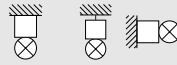

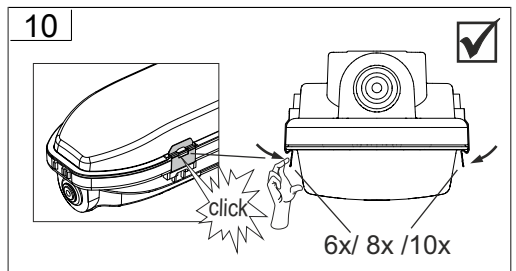
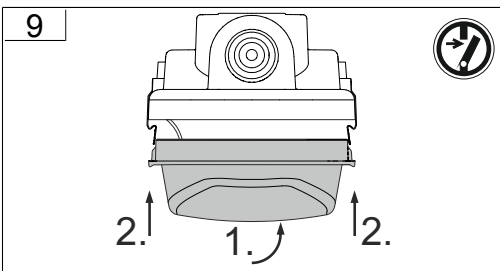
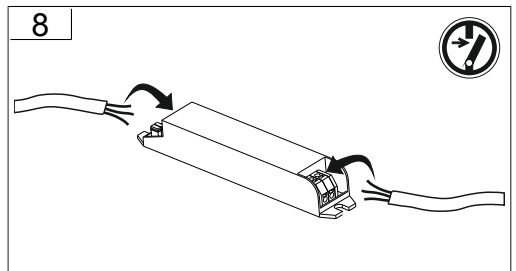
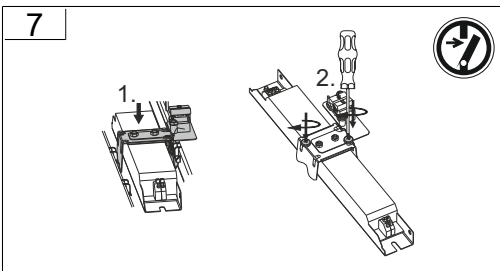
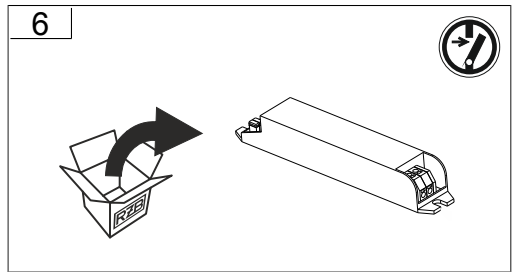
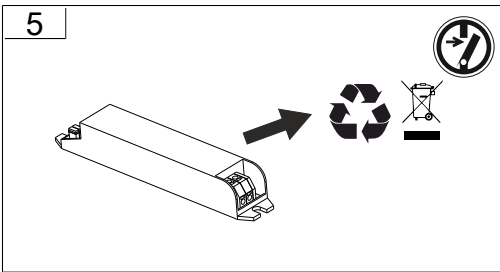
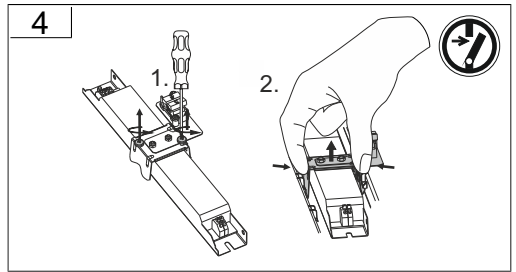
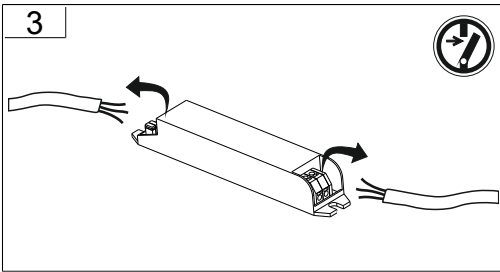
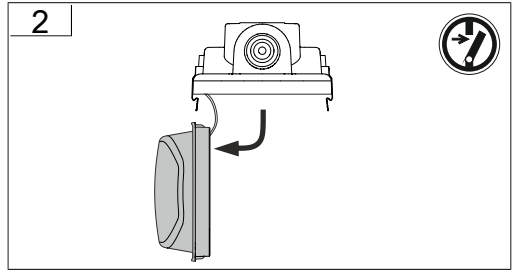
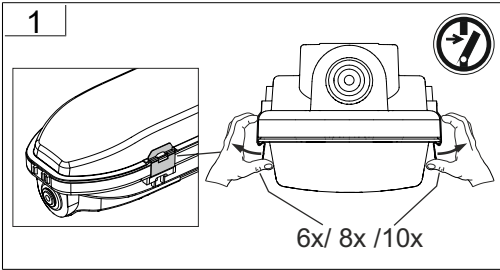

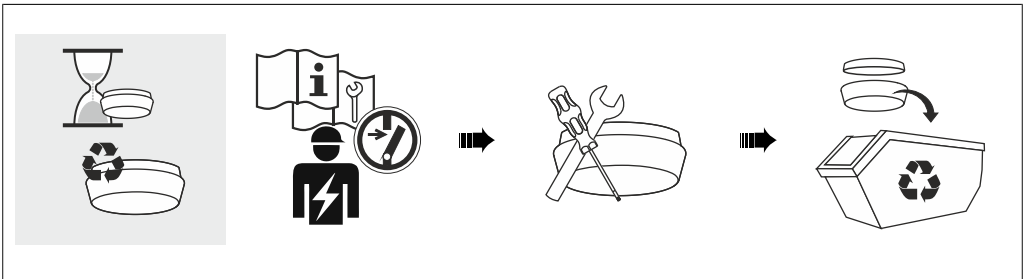
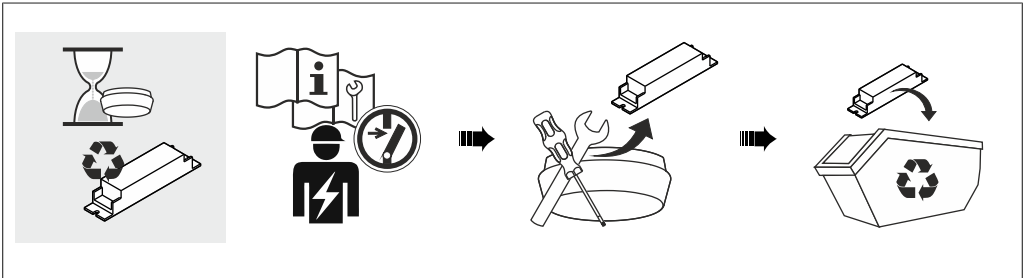
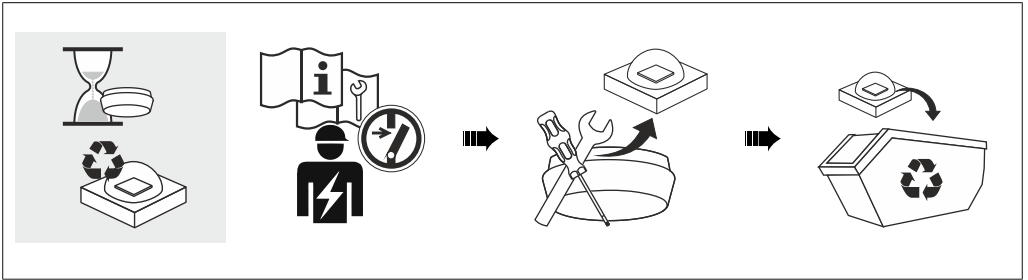



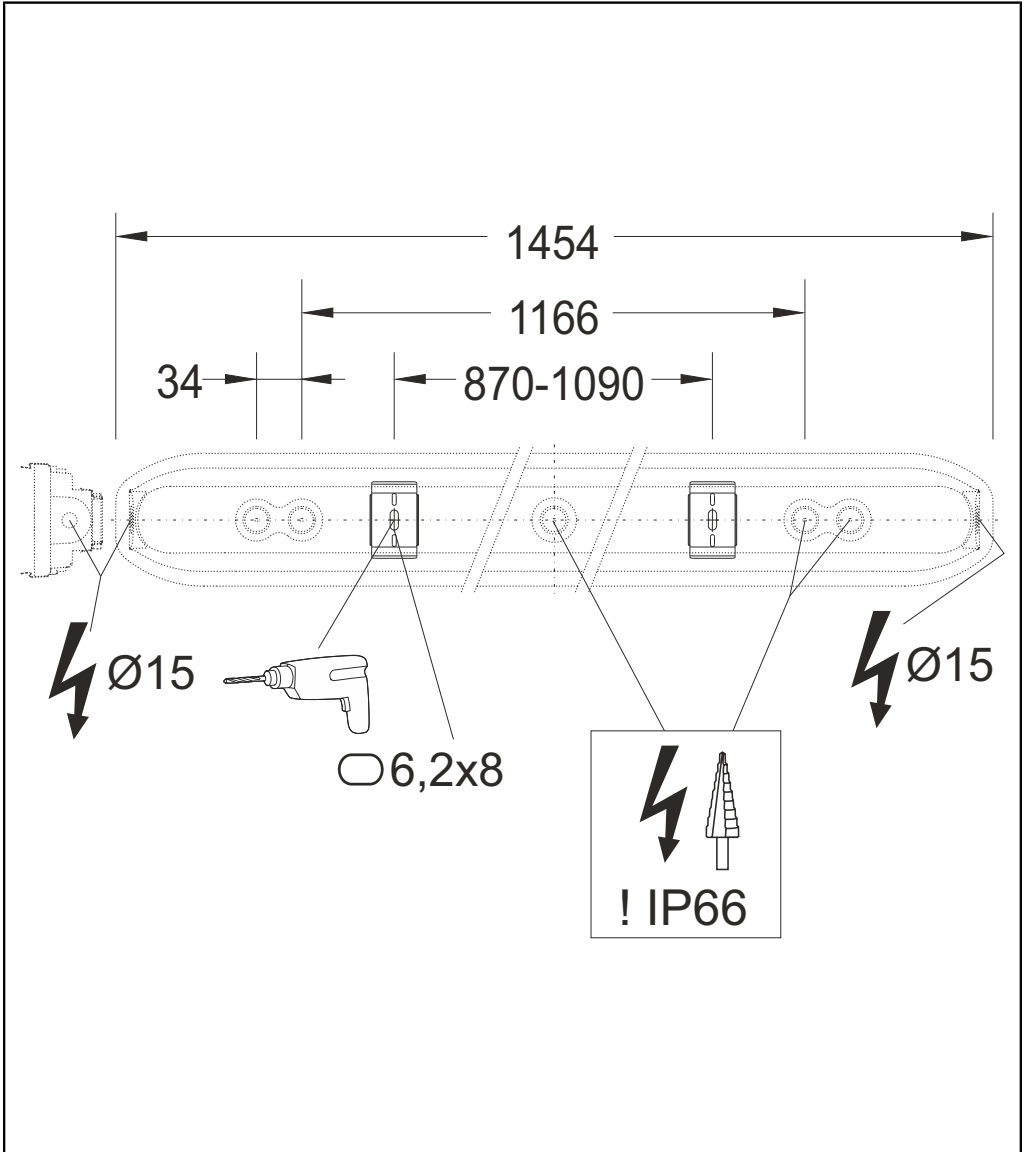

RZB - Rudolf Zimmermann, Bamberg GmbH

🏠 Rheinstraße 16, 96052 Bamberg

☎ 0951/7909-0

📠 0951/7909-198

🌐 [info@rzb-leuchten.de](mailto:info@rzb-leuchten.de)