

INSTRUCTION

Mondana
312755.002.19

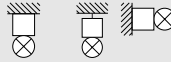

~ 220 - 240 V 50/60 Hz IP 44 IK02

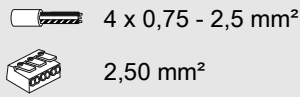

Umgebungstemperatur /
temperature ambiante
=> -20 °C ... + 35 °C

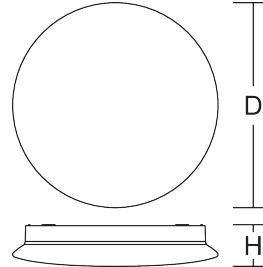

D 480, H 77

2,12 kg

	Φ [lm]	P_{in} [W]	P_{out}		
--	-------------	---------------------	------------------	--	--

LED 3950 29 1 x 26 W

CCT [K]	CRI	RG	EEK		
---------	-----	----	-----	--	--

4000 80 RG 0 C

I_{max} / I_{T50}	B10 [St.]	B16 [St.]	C10 [St.]	C16 [St.]	$\cos \varphi$
-------------------------------------	-----------	-----------	-----------	-----------	----------------

14,5 A / 150 μ s 34 54 56 92 0,9

$f_{\text{min}} - f_{\text{max}}$ [MHz]	p_{EIRP} [mW]		
---	------------------------	--	--

5725 - 5875 0,2

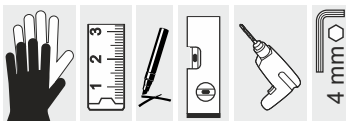



Installation erfordert
Elektro-Fachkraft!

Symbole nach ISO 7010



Allgemeine Sicherheitshinweise

- Der elektrische Anschluss muss ordnungsgemäß nach geltenden Normen und den nationalen sowie internationalen Sicherheits- und Unfallverhütungsvorschriften erfolgen.
- Beschädigte Leuchten dürfen nicht betrieben werden.
- Keine Haftung für Schäden durch unsachgemäßen Einsatz.
- Bei Instandsetzung nur Originalteile verwenden.
- Tragfähigkeit der Decke und Befestigungselemente sicherstellen.

Betrieb der Leuchte

- Die unzulässigen Umgebungstemperaturen reduzieren die Lebensdauer der Leuchte, im Extremfall droht der Frühausfall.
- Zur Vermeidung von EMV-Problemen die Durchgangsverdrahtung nicht entlang der Leuchtenverdrahtung führen.
- Steuereingänge von dimmbaren Leuchten mit handelsüblichen für Netzspannung geeigneten Leitungen anschließen.

Manipulationen unserer Produkte sind unzulässig

Veränderung, Umarbeitung, Umkennzeichnung von Produkten sowie deren Verpackung sind unzulässig und verletzen u.a. unsere eingetragenen Warenzeichenrechte. Solche Modifikationen können technische Eigenschaften unserer Produkte negativ beeinflussen, diese zerstören und möglicherweise Folgeschäden an anderen Objekten verursachen. Für durch derartige Modifikationen verursachte Schäden kann der Hersteller in keinem Fall verantwortlich gemacht werden.



Installation requires
a qualified electrician!

Symbols according
to ISO 7010



General Safety Information

- Electric connection must be appropriate according to all applicable standards and other national and international safety and accident prevention regulations.
- Damaged luminaires must not be operated.
- No liability is accepted for damages resulting from improper use.
- Use genuine parts only for repair.
- Ensure stability of the ceiling and fastening elements.

Operation of the luminaire

- Exceeding the permissible ambient temperature will reduce the luminaire's lifecycle, resulting in premature failure in extreme cases.
- Avoid ESD problems by not routing feed-through wiring directly along the wiring of the luminaire.
- Connect control inputs of dimmable luminaires with standard cables suitable for power supply voltage.

Manipulation of our products is not permitted

Modifications, reworking, re-labelling of products as well as their package is not permitted and infringes, amongst others, our registered trademark rights. Such modifications may affect technical properties of our products, damage them and possibly cause consequential damage to other objects. The manufacturer shall not be responsible under any circumstances for damage caused by such modifications.



Bei Fragen zu unseren Symbolen, besuchen Sie folgende Webseite:
If you have any questions about our signs, visit the following website:

https://www.rzb.de/fileadmin/assets/downloads/PDF/RZB_Symbolklaerung.pdf

EEK

Dieses Produkt enthält eine Lichtquelle der Energieeffizienzklasse C entsprechend Verordnung (EU) 2019/2015

This product contains a light source of energy efficiency class C according to regulation (EU) No 2019/2015

Jede zersprungene Schutzabdeckung ist zu ersetzen. DIN EN 60598

Replace any cracked protective shield. IEC DIN EN 60598

Die Lichtquelle dieser Leuchte darf nur vom Hersteller oder einem von ihm beauftragten Servicetechniker oder einer vergleichbar qualifizierten Person ersetzt werden. DIN EN 60598-1 / IEC 60598-1

The light source contained in this luminaire shall only be replaced by the manufacturer or his service agent or a similar qualified person. DIN EN 60598-1 / IEC 60598-1



Hinweis zum Einsatz von Leuchten mit D - Kennzeichnung nach EN 60598-2-24
 Reference for application of lumiaires with D - marking according to EN 60598-2-24



Umgebung ohne Staubablagerung
 Environment without dust deposit



Umgebung mit nicht elektrisch leitender Staubablagerung
 Environment with non-electrically conductive dust deposit

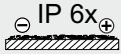

Umgebung mit elektrisch leitender Staubablagerung
 Environment with electrically conductive dust deposit

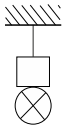

Das Zubehör zur Aufhängung der Leuchte ist vor jeder Inbetriebnahme durch den Anwender auf Schäden zu prüfen.

The accessory for suspending the luminaire must be checked by the user for damage before each commissioning.

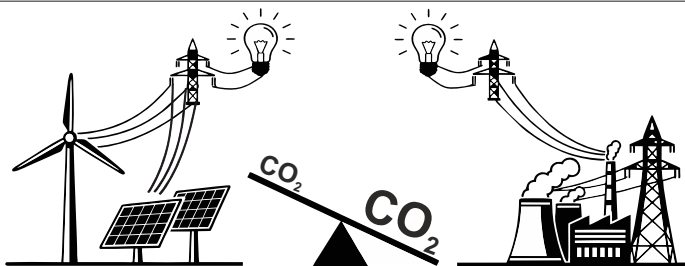
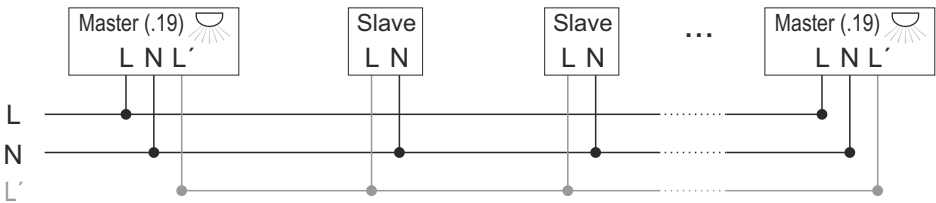



Werkseinstellung / factory setting

Erfassungsbereich / Detection Range

	1	2	3	
I	●	●	●	100%
II	●	○	●	75%
III	○	○	●	50%
IV	○	●	○	25%
V	●	○	○	10%

Haltezeit / Hold Time

	1	2	3	4	
I	●	●	●	●	30min
II	○	○	○	●	20min
III	○	○	●	○	6min
IV	○	●	○	○	90s
V	●	○	○	○	30s
VI	○	○	○	○	10s

Helligkeitsschwelle / Daylight Threshold

	1	2	3	4	
I	●	●	●	●	Disabled
II	○	○	●	○	50 lux
III	○	●	○	○	30 lux
IV	●	○	○	○	10 lux
V	○	○	○	○	5 lux

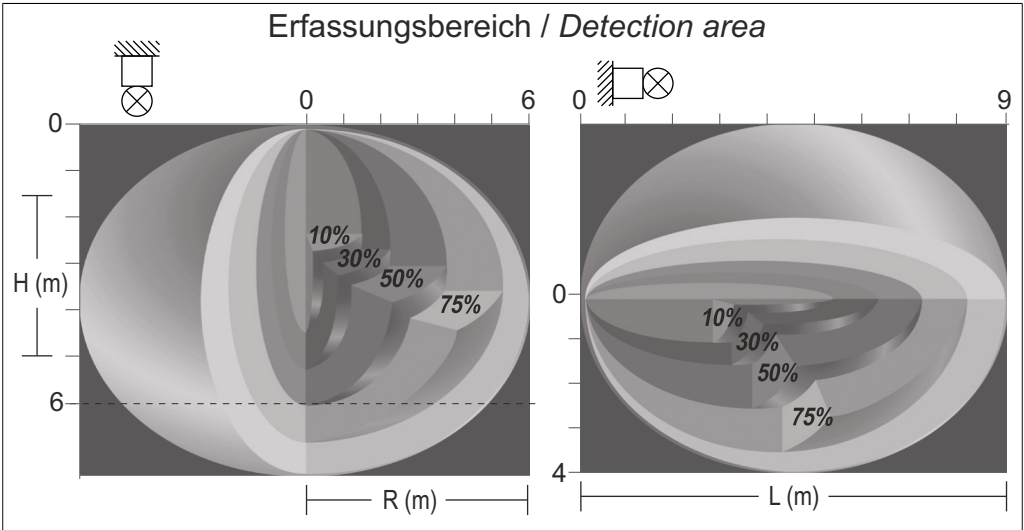



Funktionsparameter des Bewegungsmelders bei einer Deckenmontage von bis zu 6,0 m bzw. bei einer Wandmontage von bis zu 2,5 m:

- HF-Bewegungsmelder und Lichtsensor
- Betriebsfrequenz 5,8 GHz
- Erfassungswinkel 150°
- Erfassungsbereich bis zu 6 m radial, abhängig von Montagehöhe
- Als Masterleuchte bis 800 W (ohmsche Last), 400 VA (LED) schaltbar
- Funktionen über Dip-Schalter einstellbar
- Empfindlichkeit: 10 - 100 %, in 5 Stufen einstellbar
- Haltezeit: 10 Sek. - 30 Min., in 6 Stufen einstellbar
- Helligkeitsschwellenwert: Deaktiviert / 5 - 50 lx, in 5 Stufen einstellbar

Functional parameters of the motion detector when mounted on the ceiling up to 6.0 m or when mounted on the wall up to 2.5 m:

- HF motion detector and light sensor
- Operation frequency 5,8 GHz
- Detection angle 150°
- Detection range up to 6 m radial, depending on mounting height
- Can be switched as a master light up to 800 W (resistive load), 400 VA (LED) switchable
- Functions adjustable via dip switch
- Sensitivity: 10 - 100 %, adjustable in 5 levels
- Holding time: 10 sec. - 30 min., adjustable in 6 levels
- Brightness threshold: Disabled / 5 - 50 lx, adjustable in 5 levels

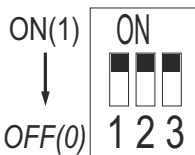

	[mA]	P _☐ [W]	CCT 3000		CCT 4000				
			Φ _☐ [lm]	Φ _☐ [lm]	Φ _☐ [lm]	Φ _☐ [lm]			
	350	15	2000	2100		550	23	3050	3200
	400	17	2250	2350		600	25	3300	3500
	450	19	2500	2600		650	27	3600	3800
	500	21	2750	2900		700	29	3750	3950



EU-Konformitätserklärung
EU Declaration of Conformity
Déclaration UE de conformité
Declaración UE de conformidad
Deklaracja zgodności UE



Hersteller, Anschrift:
Manufacturer, address:
Fabricant, adresse:
Fabricante, dirección:
Producent, adres:

RZB Rudolf Zimmermann, Bamberg GmbH
Rheinstrasse 16
96052 Bamberg
Deutschland / Germany / Allemagne / Alemania / Niemcy

Wir erklären in alleiniger Verantwortung, dass das Produkt
 We declare under sole responsibility that the product
 Nous déclarons, sous notre propre responsabilité, que le produit
 Declaramos bajo nuestra sola responsabilidad que el producto
 Deklarujemy z pełną odpowiedzialnością, że produkt

Produktbezeichnung:

Product designation: **Mondana**
Description des produits: **312755.002.19**
Designación de producto:
Oznaczenie produktu:

mit den folgenden EU-Richtlinien und Normen übereinstimmt:
 complies with the following EU Directives and standards:
 est conforme aux normes et directives de l'UE suivantes:
 cumple con las siguientes directivas y normas CE:
 jest zgodny z następującymi dyrektywami UE i normami:

<p>RED Directive 2014/53/EU</p>	<p>(3.1a) EN 60598-1:2021/A11:2022 EN 60598-2-1:1989 EN 60598-2-24:2013 EN 62471:2008 EN 62493:2010 (3.1b) EN 55015:2019/A11:2020 EN 61000-3-2:2019/A1:2021 EN 61000-3-3:2013+A1:2019+A2:2021+A2:2021/AC:2022 EN 61547:2023 (3.2) EN 300 440 V2.1.1</p>
<p>RoHS Directive 2011/65/EU</p>	<p>EN 63000:2018</p>
<p>ErP Directive 2009/125/EC</p>	<p>(EU) 2019/2020</p>

Dokument-Nr. / Document No. / Document No.
 Document No. / Nr dokumentu

24031724

Aussteller / Issuer / Délivré par:
 Otagante / Wystawca:

RZB Rudolf Zimmermann, Bamberg GmbH

Ort, Datum / Place, Date / Lieu, date:
 Lugar, Fecha / Miejsce, data:

Bamberg, 25.10.2024

Rechtsverbindliche Unterschrift:
 Legally binding signature:
 Signature juridiquement obligatore:
 Firma legalmente vinculante:
 Prawnie wiązacy podpis:

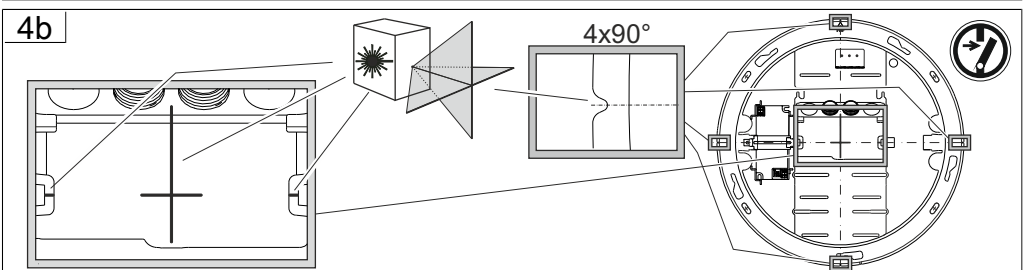
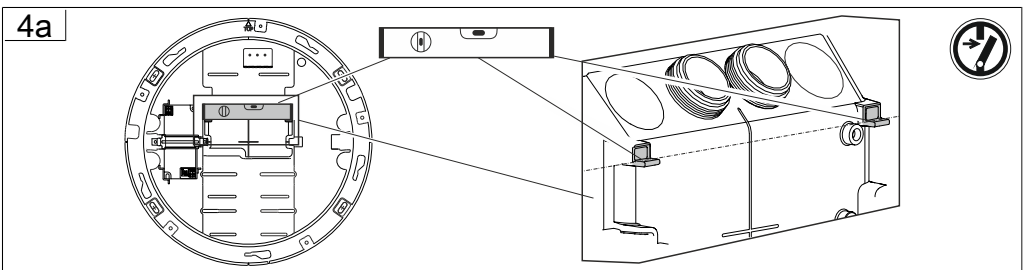
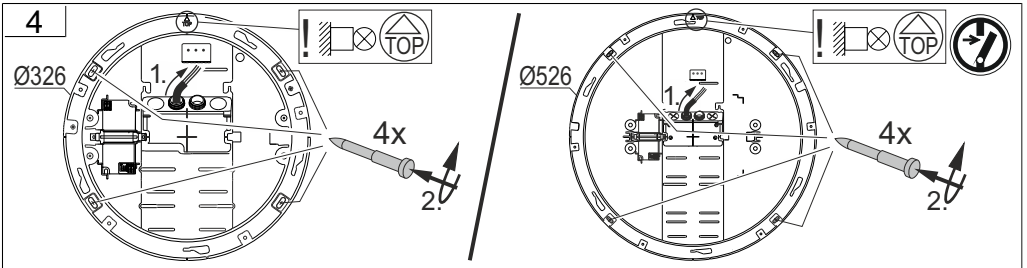
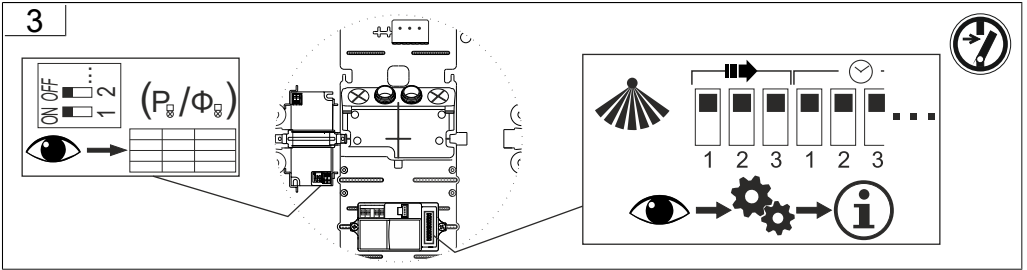
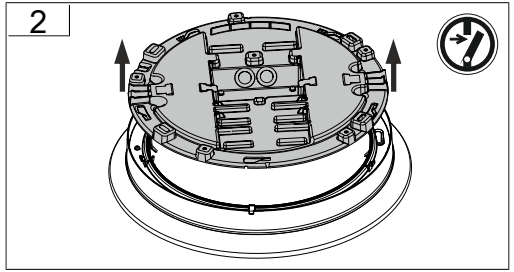
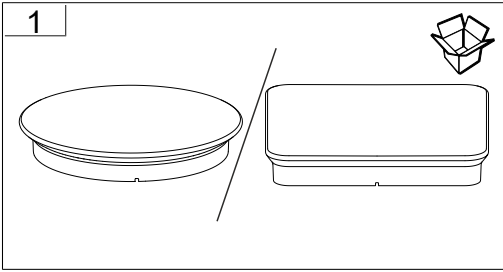

 Reiner Jürgens
 CEO/Direktor Zarządzający/Geschäftsführer

1/1



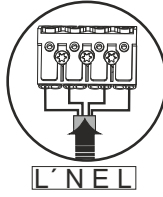

5



12+1
1,5 - 2,5 mm²

6

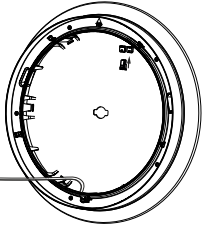
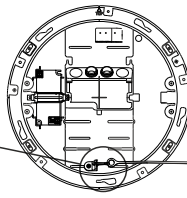
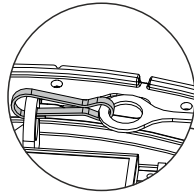
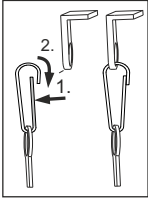

7

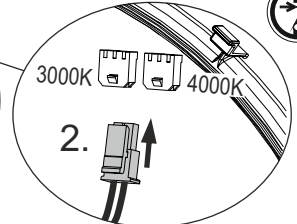
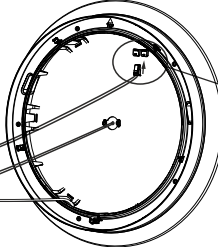
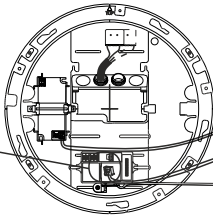
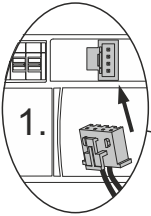

8

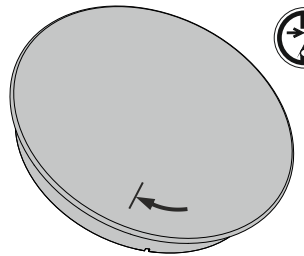
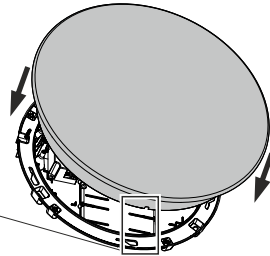
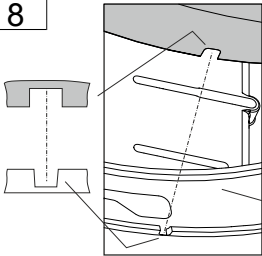

9

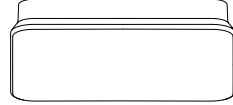
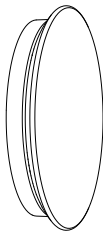

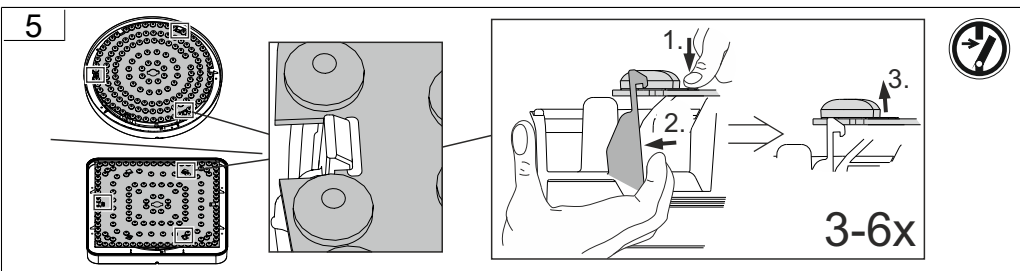
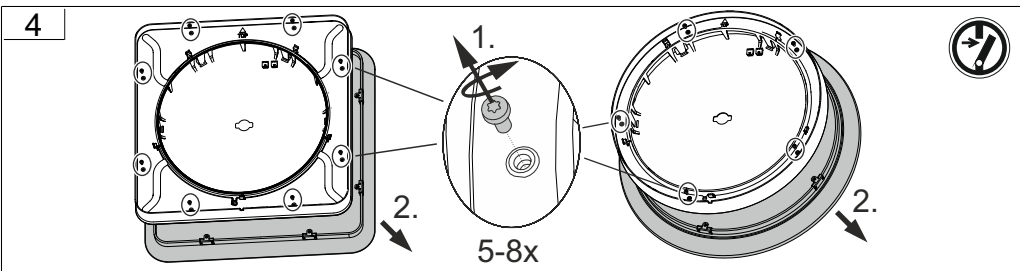
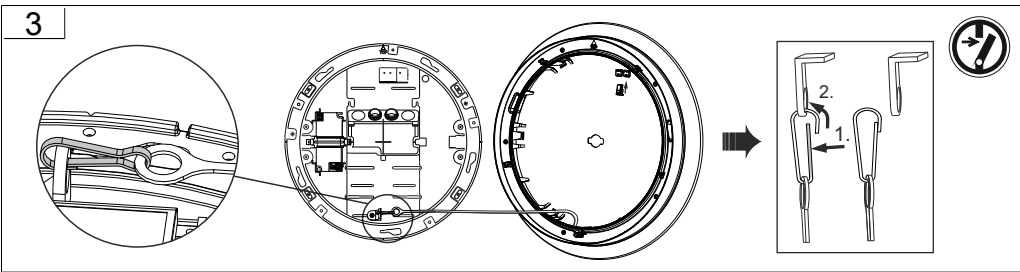
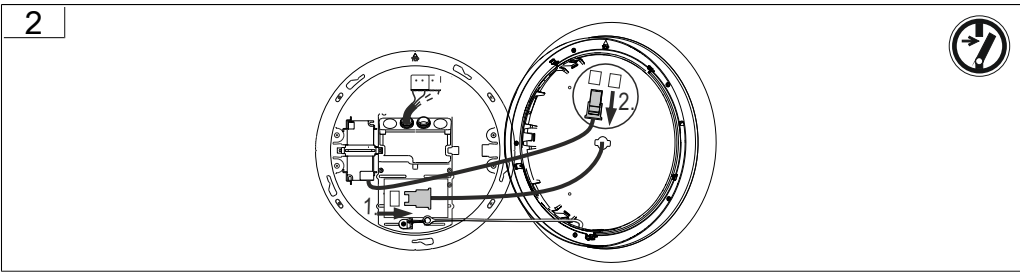
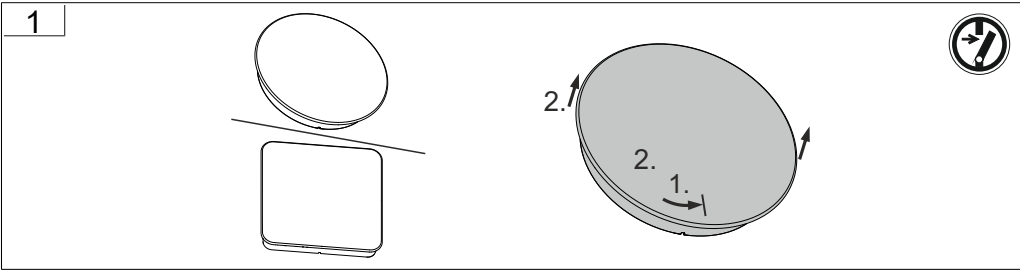

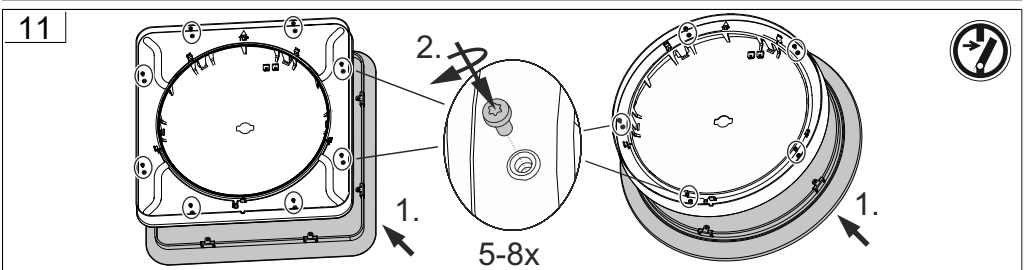
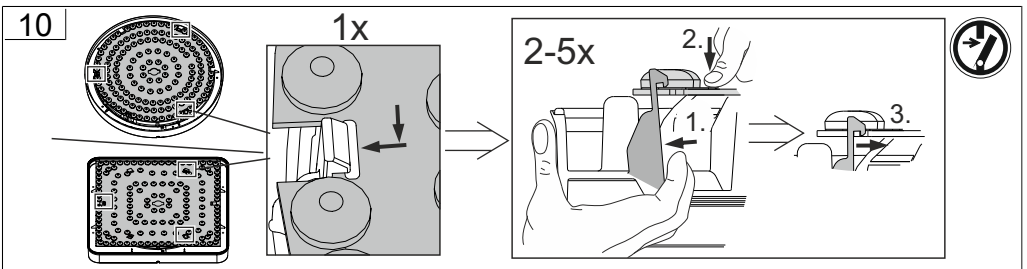
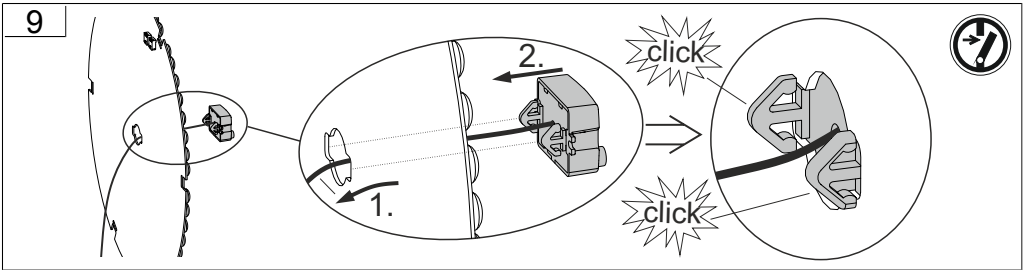
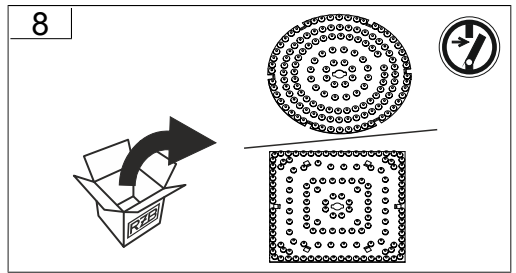
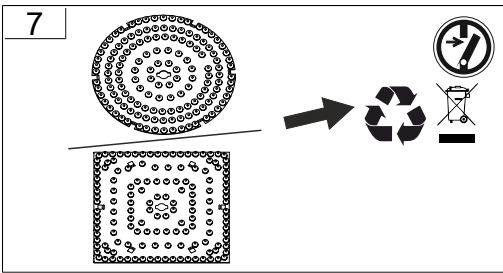
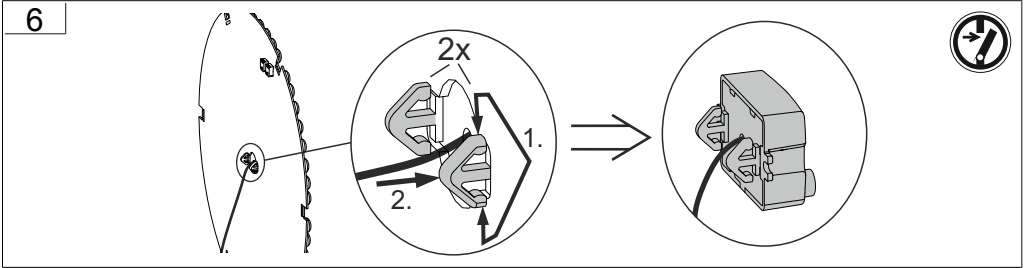



12

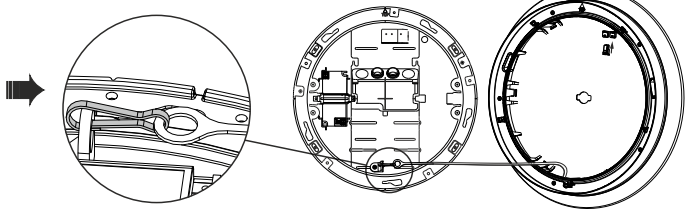
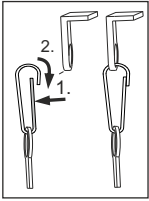

13

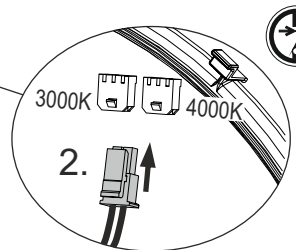
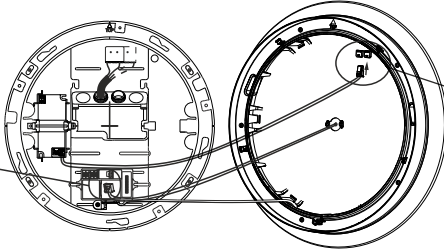
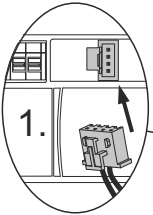

14

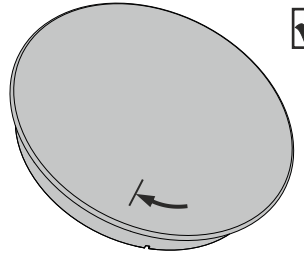
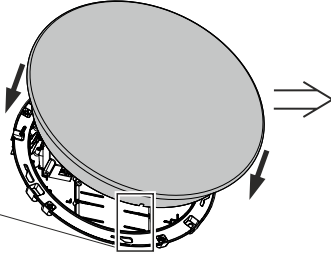
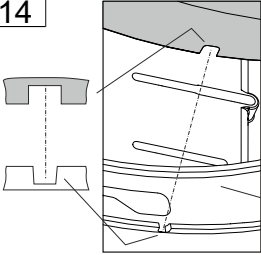

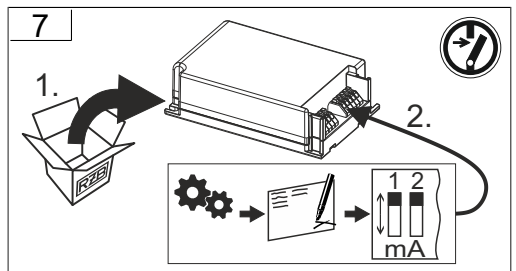
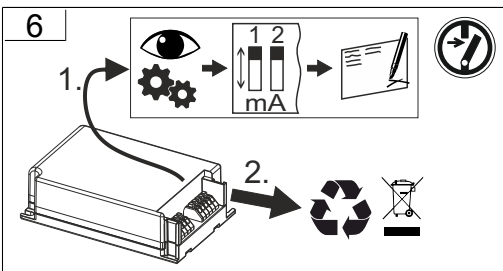
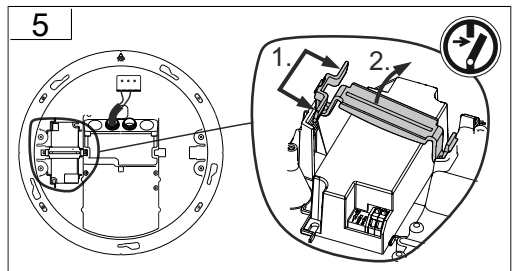
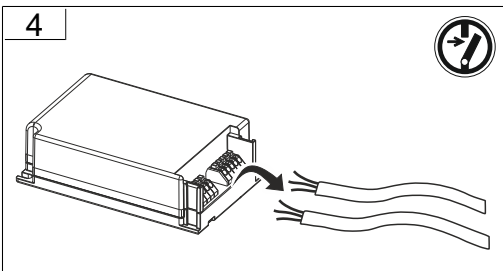
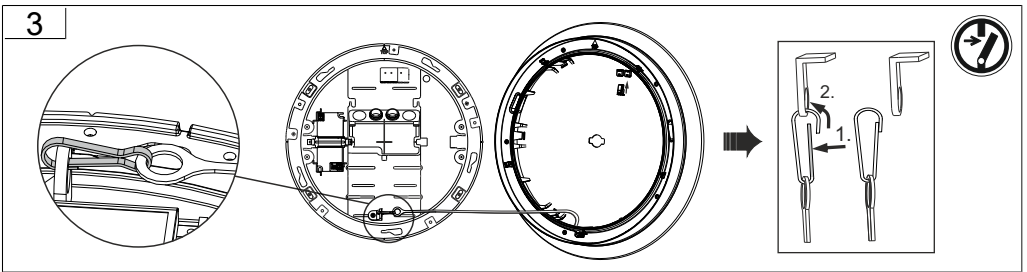
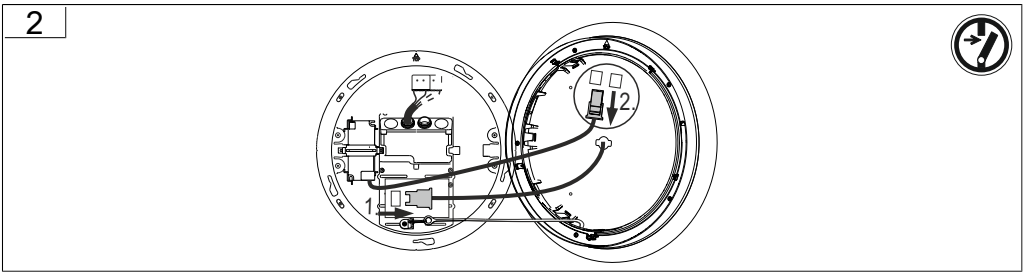
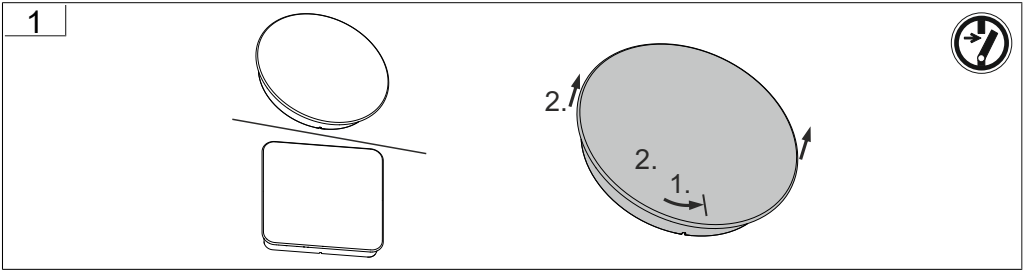



8

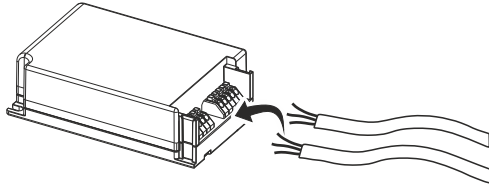

9

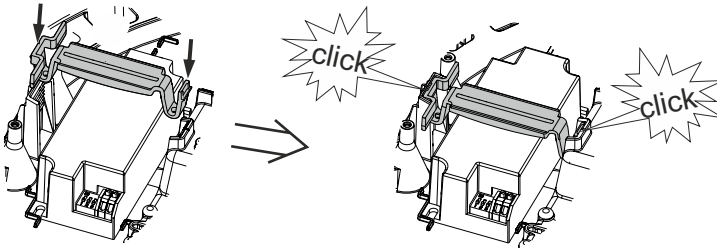

10

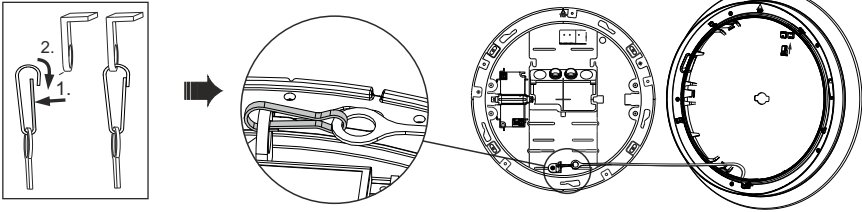

11

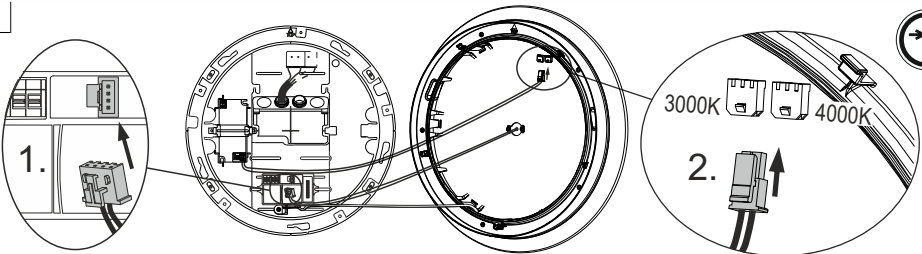

12

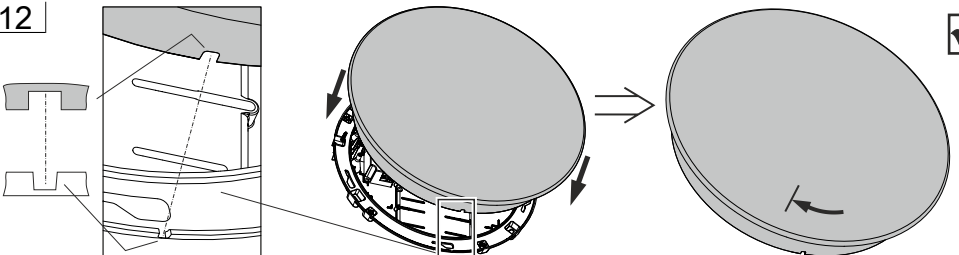

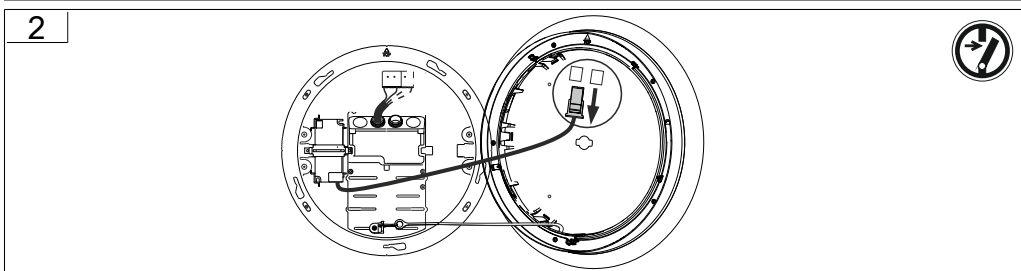
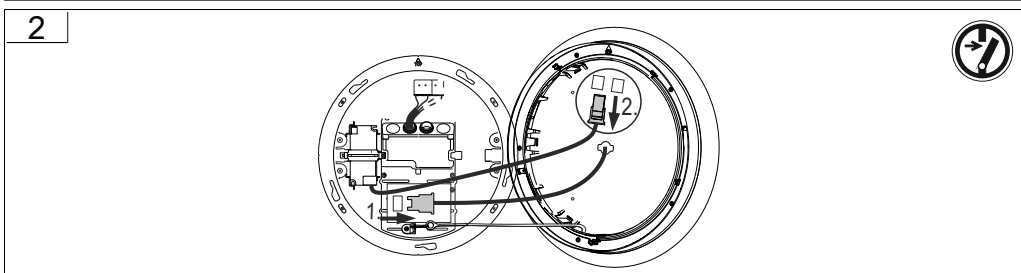
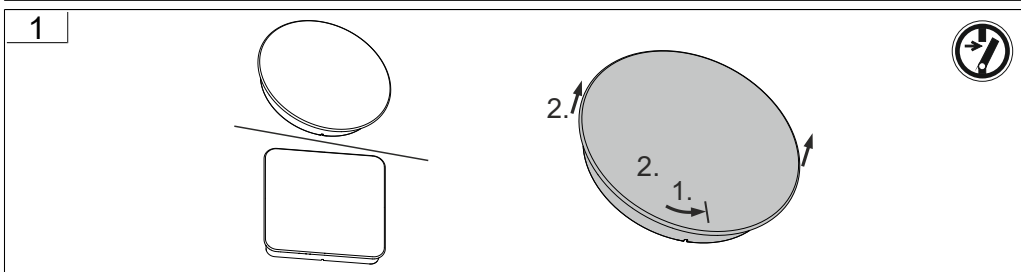
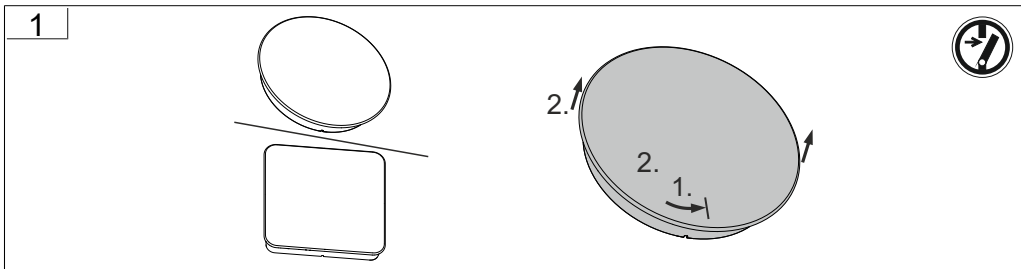



3

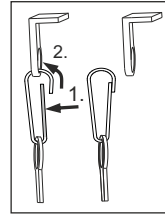
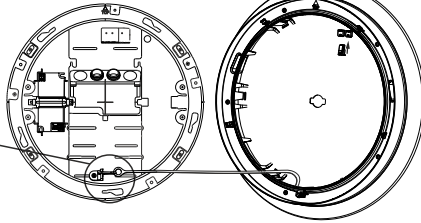
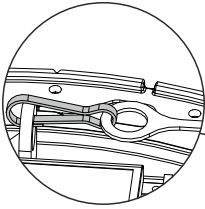

3

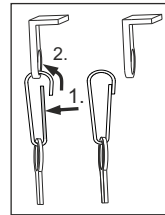
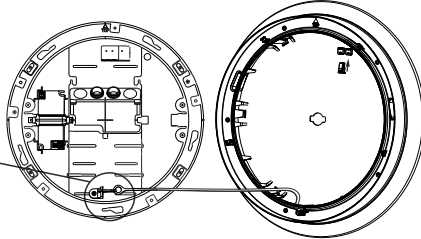
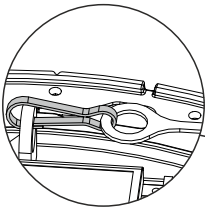

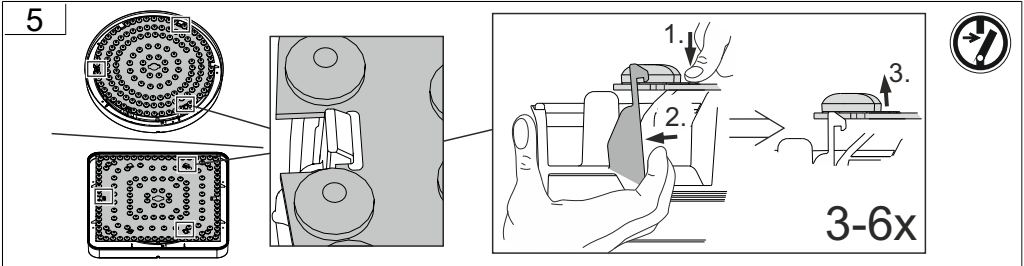
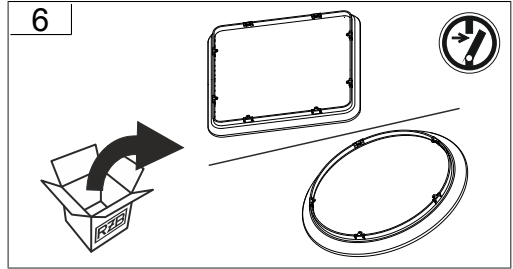
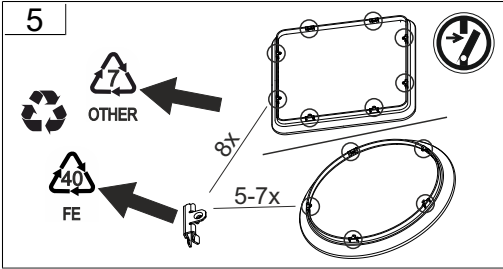
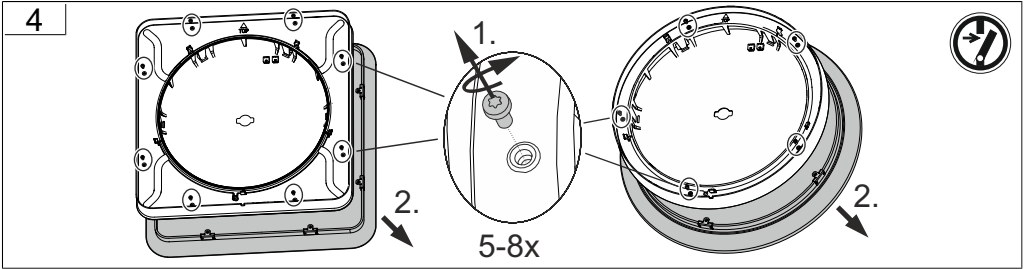
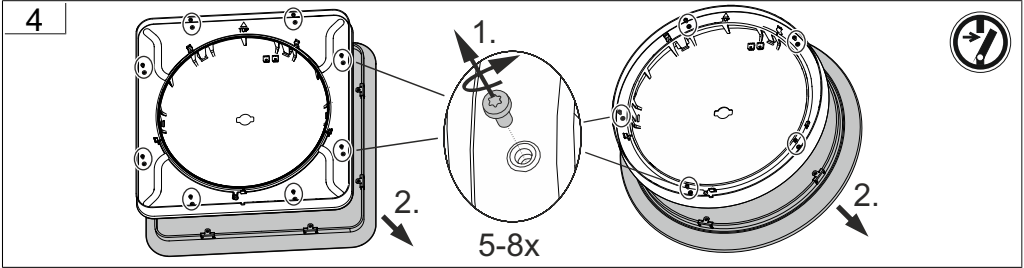

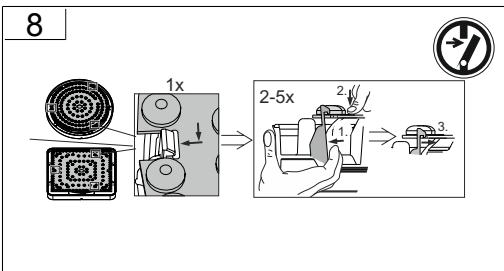
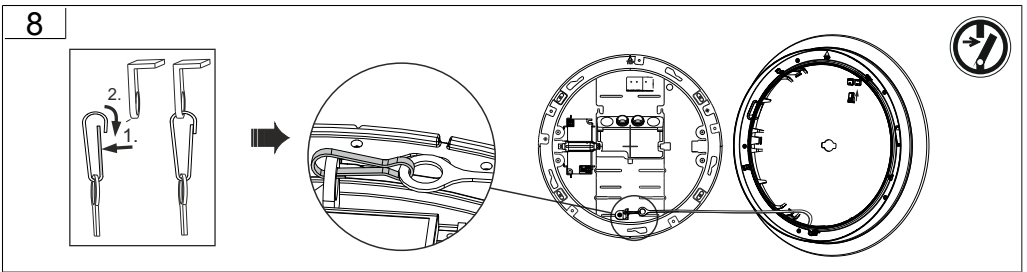
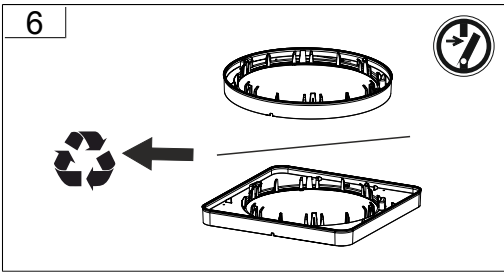
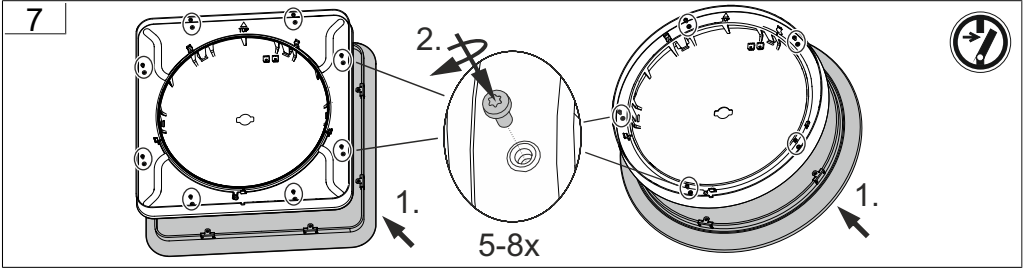

9

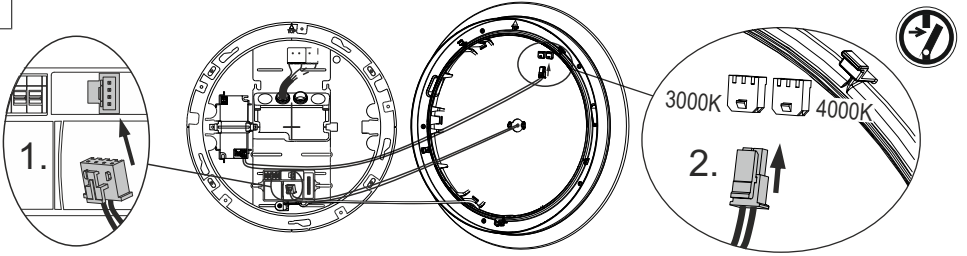

9

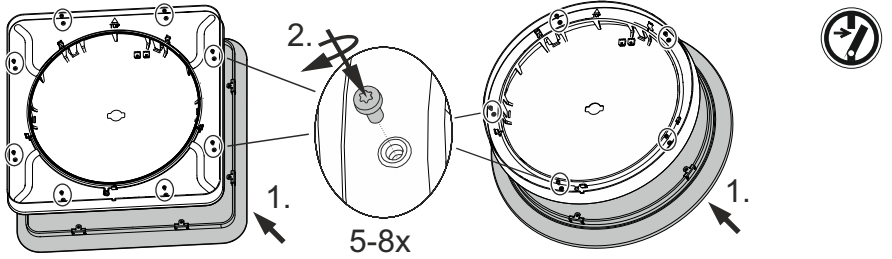

10

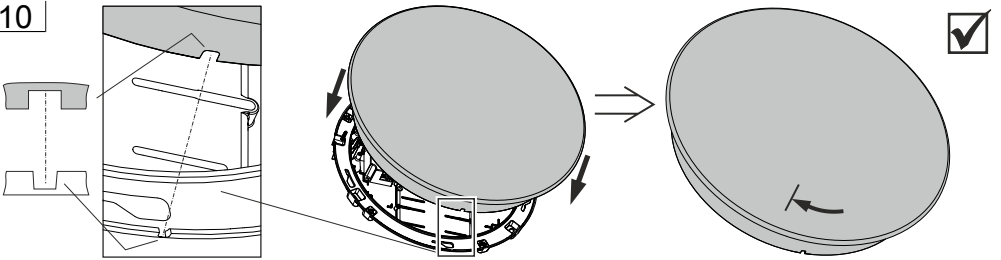

10

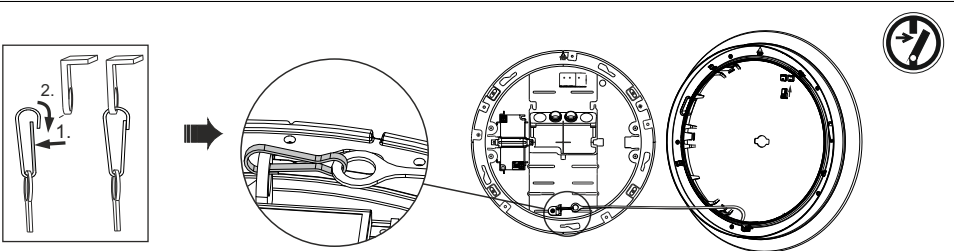

11

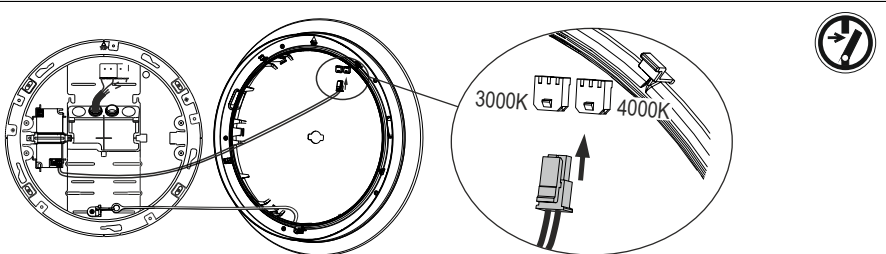

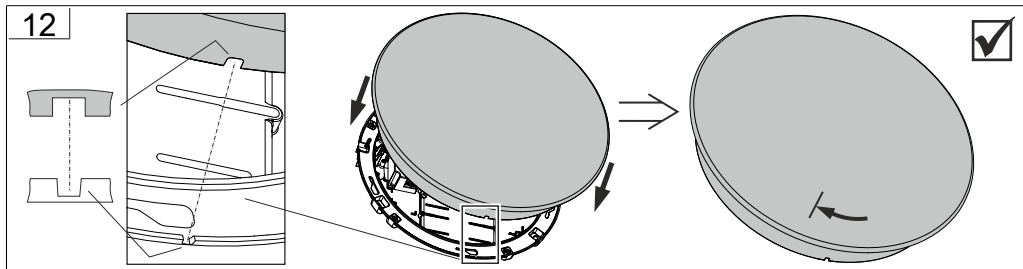

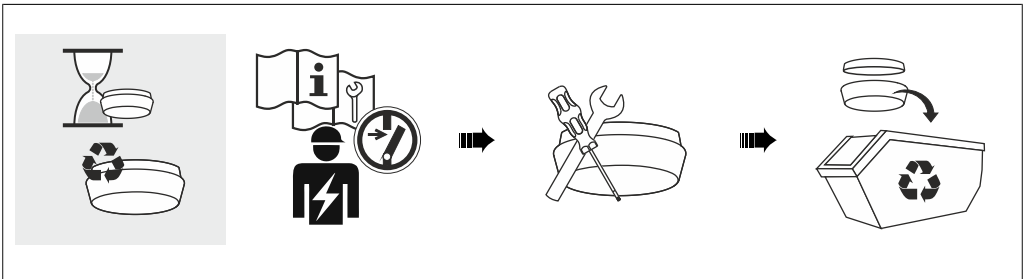
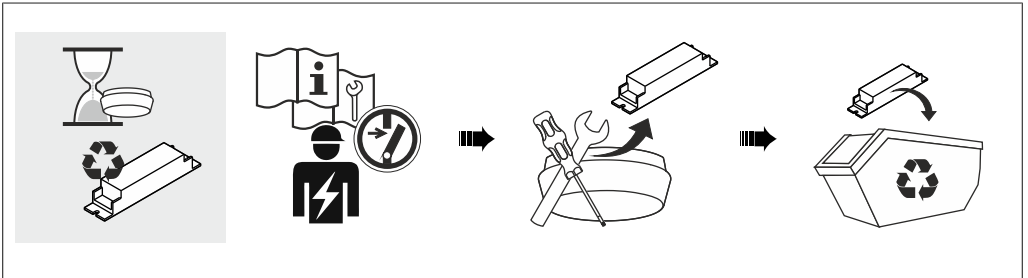
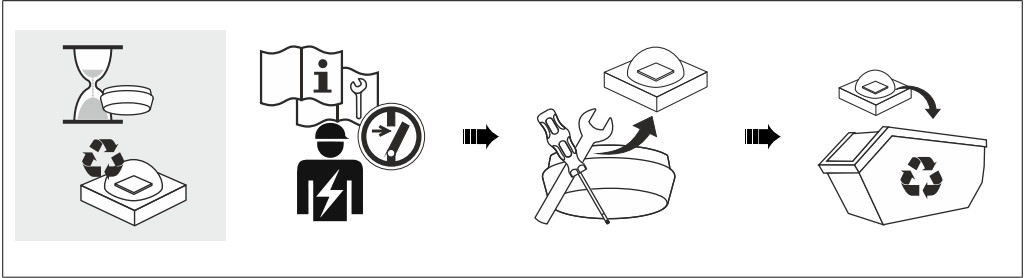





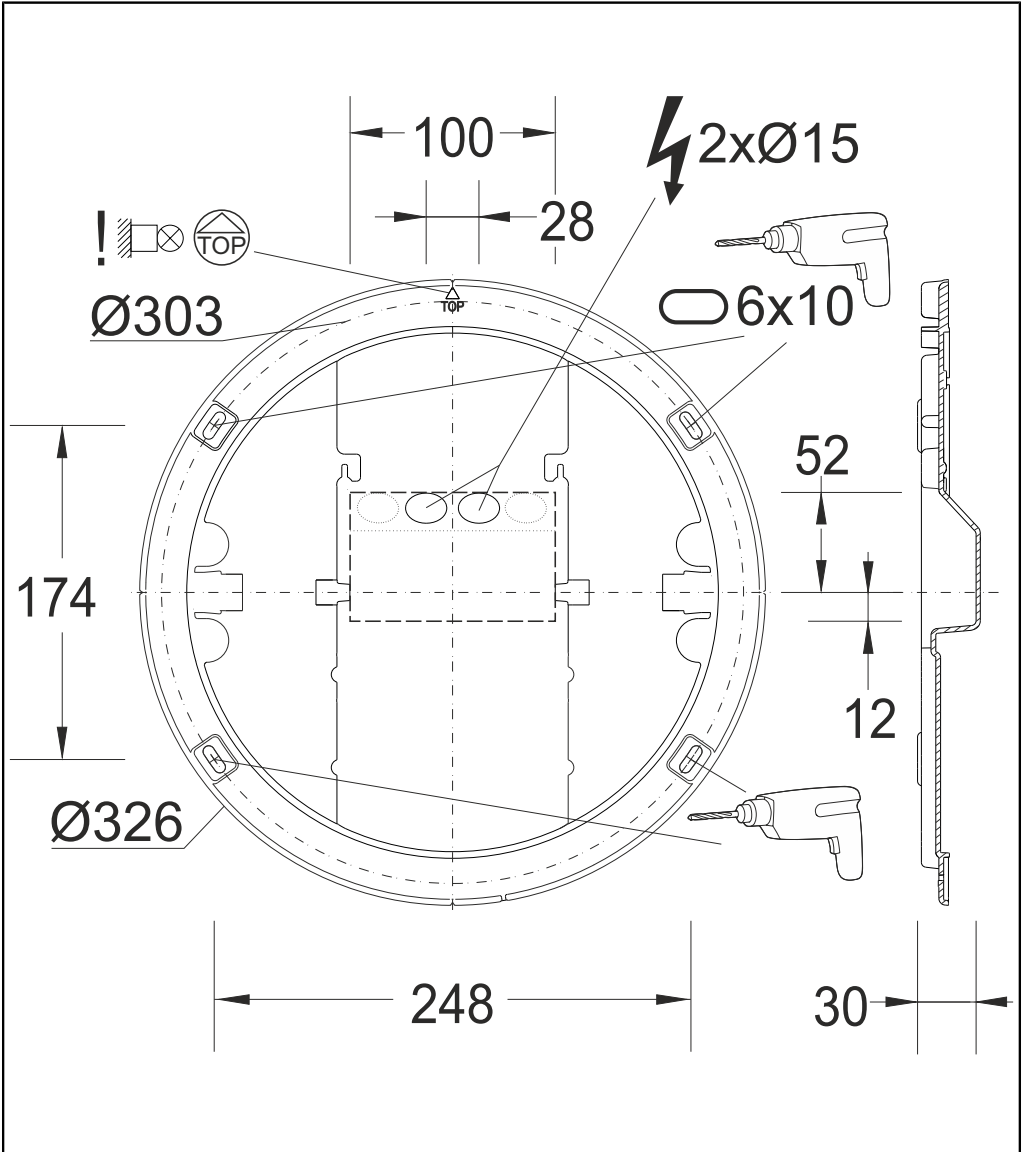

RZB - Rudolf Zimmermann, Bamberg GmbH

🏠 Rheinstraße 16, 96052 Bamberg

☎ 0951/7909-0

📠 0951/7909-198

🌐 info@rzb-leuchten.de