

INSTRUCTION

Mondana
672835.002.3.19.F1

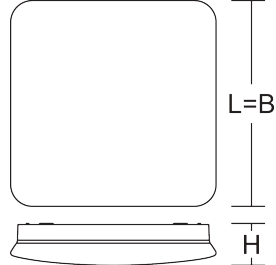

<p>5 x 2,5 mm² 2,50 mm²</p>		<p>Dauerschaltung / maintained => 5 °C ... + 30 °C Bereitschaftsschaltung / non maintained => 5 °C ... + 30 °C</p>	<p>3 h LiFePo4 3,2 V - 4,5 Ah</p>
---	--	--	---



<p>1 2 3 [mm]</p>	<p>4,1 kg</p>
-------------------	---------------

L 580, B 580, H 77

<p>LED</p>	<p>Φ 350</p>	<p>P 1 x 42 W</p>	
------------	------------------------------	-------------------	--

<p>CRI 80</p>	<p>RG 0</p>	<p>EEK D</p>	
---------------	-------------	--------------	--

<p>I_{max} 15,6 A / 248 μs</p>	<p>B10 [St.] 16</p>	<p>B16 [St.] 26</p>	<p>C10 [St.] 27</p>	<p>C16 [St.] 44</p>	<p>COS φ 0,9</p>
--	---------------------	---------------------	---------------------	---------------------	-------------------------------------

<p>$f_{min} - f_{max}$ [MHz] 2400 - 2483</p>	<p>p_{EIRP} [dBm] 6</p>
---	--------------------------------------

--	--	--	--	--	--

--	--

--	--





Installation erfordert
Elektro-Fachkraft!
Symbole nach ISO 7010



Allgemeine Sicherheitshinweise

- Der elektrische Anschluss muss ordnungsgemäß nach geltenden Normen und den nationalen sowie internationalen Sicherheits- und Unfallverhütungsvorschriften erfolgen.
- Beschädigte Leuchten dürfen nicht betrieben werden.
- Keine Haftung für Schäden durch unsachgemäßen Einsatz.
- Bei Instandsetzung nur Originalteile verwenden.
- Tragfähigkeit der Decke und Befestigungselemente sicherstellen.

Betrieb der Leuchte

- Die unzulässigen Umgebungstemperaturen reduzieren die Lebensdauer der Leuchte, im Extremfall droht der Frühausfall.
- Zur Vermeidung von EMV-Problemen die Durchgangsverdrahtung nicht entlang der Leuchtenverdrahtung führen.
- Steuereingänge von dimmbaren Leuchten mit handelsüblichen für Netzspannung geeigneten Leitungen anschließen.

Manipulationen unserer Produkte sind unzulässig

Veränderung, Umarbeitung, Umkennzeichnung von Produkten sowie deren Verpackung sind unzulässig und verletzen u.a. unsere eingetragenen Warenzeichenrechte. Solche Modifikationen können technische Eigenschaften unserer Produkte negativ beeinflussen, diese zerstören und möglicherweise Folgeschäden an anderen Objekten verursachen. Für durch derartige Modifikationen verursachte Schäden kann der Hersteller in keinem Fall verantwortlich gemacht werden.



Installation requires
a qualified electrician!
Symbols according
to ISO 7010



General Safety Information

- Electric connection must be appropriate according to all applicable standards and other national and international safety and accident prevention regulations.
- Damaged luminaires must not be operated.
- No liability is accepted for damages resulting from improper use.
- Use genuine parts only for repair.
- Ensure stability of the ceiling and fastening elements.

Operation of the luminaire

- Exceeding the permissible ambient temperature will reduce the luminaire's lifecycle, resulting in premature failure in extreme cases.
- Avoid ESD problems by not routing feed-through wiring directly along the wiring of the luminaire.
- Connect control inputs of dimmable luminaires with standard cables suitable for power supply voltage.

Manipulation of our products is not permitted

Modifications, reworking, re-labelling of products as well as their package is not permitted and infringes, amongst others, our registered trademark rights. Such modifications may affect technical properties of our products, damage them and possibly cause consequential damage to other objects. The manufacturer shall not be responsible under any circumstances for damage caused by such modifications.



DIN EN IEC 61340-5-1

Bei Fragen zu unseren Symbolen, besuchen Sie folgende Webseite:

If you have any questions about our signs, visit the following website:



https://www.rzb.de/fileadmin/assets/downloads/PDF/RZB_Symbolklaerung.pdf

EEK

Dieses Produkt enthält eine Lichtquelle der Energieeffizienzklasse D entsprechend Verordnung (EU) 2019/2015

This product contains a light source of energy efficiency class D according to regulation (EU) No 2019/2015



Jede zersprungene Schutzabdeckung ist zu ersetzen. DIN EN 60598



Replace any cracked protective shield. IEC DIN EN 60598

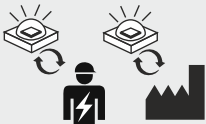

Die Lichtquelle dieser Leuchte darf nur vom Hersteller oder einem von ihm beauftragten Servicetechniker oder einer vergleichbar qualifizierten Person ersetzt werden. DIN EN 60598-1 / IEC 60598-1

The light source contained in this luminaire shall only be replaced by the manufacturer or his service agent or a similar qualified person. DIN EN 60598-1 / IEC 60598-1

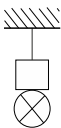
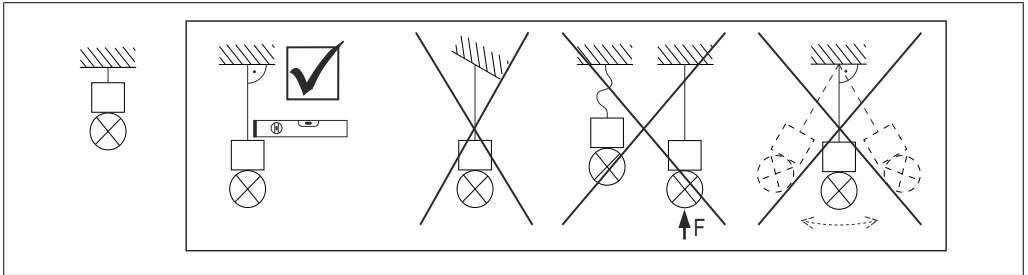

Das Zubehör zur Aufhängung der Leuchte ist vor jeder Inbetriebnahme durch den Anwender auf Schäden zu prüfen.

The accessory for suspending the luminaire must be checked by the user for damage before each commissioning.



Zur Verwendung in Anlagen nach EN 50172 / DIN VDE 0108-100

For installation according to EN-50172 / DIN VDE 0108-100

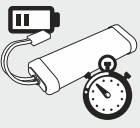

Die Sicherheitsleuchten werden generell mit entladenen oder teilentladenen Akkus ausgeliefert und müssen für die volle Funktionstüchtigkeit die vorgegebene Inbetriebnahme durchlaufen.

The emergency luminaires are delivered with either discharged or only partially charged batteries and run through the specified commissioning before reaching their fully operability.



Einteilung Notleuchten

* ** *** ****

Veränderungen am Auslieferungszustand der Leuchte sind gemäß DIN EN 60598-2-22 auf dem Typenschild zu kennzeichnen.

Classification Emergency Lighting

* ** *** ****

Modifications to the delivery condition of the luminaire must be documented on the product label accordingly to IEC 60598-2-22.

*	Typ (1-stellig)	Type (1-digit)
X	Einzelbatterie	Self-Contained
Z	Zentralbatterie	Central Supply

**	Betriebsart (1-stellig)	Operating Mode (1-digit)
0	Notleuchte Bereitschaftsschaltung	Emergency Lighting non-maintained
1	Notleuchte Dauerschaltung	Emergency Lighting maintained
2	Kombinierte Notleuchte Bereitschaftssch.	Combi. Emergency Lighting non-maintained
3	Kombinierte Notleuchte Dauerschaltung	Combined Emergency Lighting maintained

***	Einrichtungen (max. 7-stellig)	Installation (max. 7-digit)
A	manuelle Prüfeinrichtung	Manual Test Device
B	Fernschalter für Ruhe-Zustand	Including Remote Rest Mode
C	Fernausschaltemöglichkeit	Including Inhibiting Mode
D	Arbeitsstätten m. besonderer Gefährdung	High-Risk Task-Area Luminaire
E	Lampe oder Batterie nicht austauschbar	With non-replaceable Lamps or Battery
F	automatische Prüfeinrichtung	Automatic Test Device
G	von innen beleuchtetes Sicherheitszeich.	Inside illuminated safety sign

****	Betriebsdauer (2/3-stellig) (nur bei Einzelbatterie)	Duration Time (2/3-digit) (only for self-contained)
60	Betriebsdauer 60 Minuten	Duration Time 60 Minutes
180	Betriebsdauer 180 Minuten	Duration Time 180 Minutes
480	Betriebsdauer 480 Minuten	Duration Time 480 Minutes



Anschlussplan / Wiring diagramm

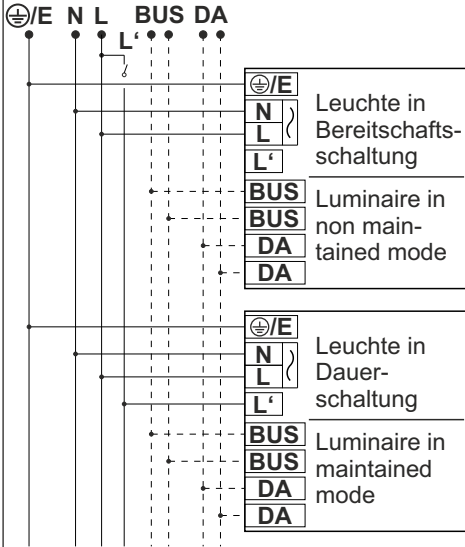

	Schutzleiter (SK I) // Ground Wire (IC I)
E	Erdung (SK II) // earthing (IC II)
N	Nullleiter // Neutral Wire
L	Dauerphase // Duration Wire
L'	Geschaltete Phase für Dauerschaltung Connected phase for maintained operation
DA	DALI .76 Standardsignal // Standard Signal (~230V) DALI-Leitungen können vertauscht werden! Connection wires may be interchanged!
	MultiDigit .04 Standardsignal // Standard Signal (<36V)
BUS	DALI .07 Standardsignal // Standard Signal (<23V) BUS-Leitungen können vertauscht werden! Connection wires may be interchanged!

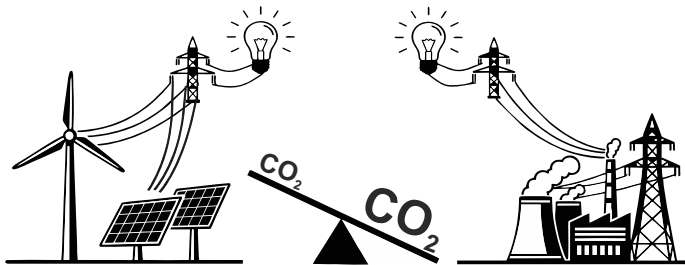

Erfassungsbereich / *Detection area*

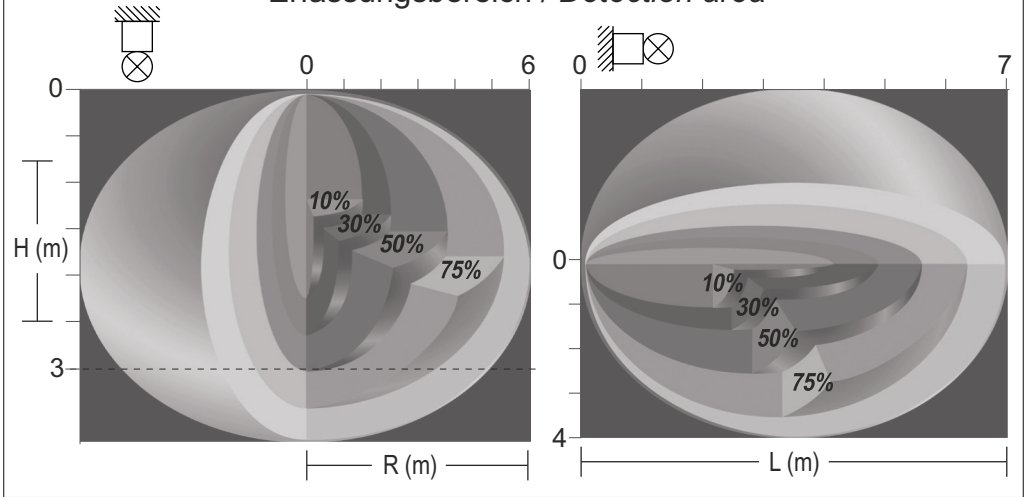



Funktionsparameter des Bewegungsmelders bei einer Deckenmontage von bis zu 3,0 m bzw. bei einer Wandmontage von bis zu 2,5 m:

- HF-Bewegungsmelder und Lichtsensor mit Bluetooth und DALI Schnittstelle
- Betriebsfrequenz 5,8 GHz
- Erfassungswinkel 150°
- Erfassungsbereich bis zu 6 m radial, abhängig von Montagehöhe
- Sensoren via Bluetooth vernetzbar
- Bis zu 15 DALI Konverter Broadcast steuerbar (30 mA integrierte DALI-Stromversorgung)
- Corridor Function
- Funktionen via App einstellbar
- Empfindlichkeit: 10 - 100 %, stufenlos einstellbar
- Haltezeit: 4 Sek. - 10 h, stufenlos einstellbar
- Helligkeitsschwellenwert: 2 - 1000 lx, stufenlos einstellbar

Functional parameters of the motion detector when mounted on the ceiling up to 3.0 m or when mounted on the wall up to 2.5 m:

- HF motion detector and light sensor with Bluetooth and DALI interface
- Operation frequency 5,8 GHz
- Detection angle 150°
- Detection range up to 6 m radial, depending on mounting height
- Sensors can be networked via Bluetooth
- Up to 15 DALI converters broadcast controllable (30 mA integrated DALI power supply)
- Corridor function
- Functions adjustable via app
- Sensitivity: 10 - 100 %, continuously adjustable
- Holding time: 4 sec. - 10 h, continuously adjustable
- Brightness threshold: 2 - 1000 lx, continuously adjustable

Funktionsanzeige LED / Indicator LED

	<u>intermittierend grün (8s)</u> <u>intermittently green (8s)</u>	<u>Akku Regenerierung</u> <u>battery regeneration</u>
	<u>permanent grün</u> <u>permanently green</u>	<u>keine Störung</u> <u>no fault</u>
	<u>permanent rot blinkend</u> <u>continuously flashing red</u>	<u>Fehler Akku</u> <u>battery fault</u>
	<u>intermittierend rot blinkend</u> <u>intermittently flashing red</u>	<u>Fehler Leuchtmittel</u> <u>luminaire fault</u>
	<u>dunkel</u> <u>dark</u>	<u>Notbetrieb / kein Netz</u> <u>emergency operation / no mains</u>

Kontrolle nach der Installation

30 Minuten nach der Inbetriebnahme muss die Status-LED grün leuchten. Wenn die LED nicht leuchtet, ist die Ladung durch fehlende Netzspannung, unterbrochene Leitung zum Akku oder defekte Ladeinheit nicht gewährleistet.

Optimierung der Lebensdauer des Akkus

Bei jeder Inbetriebnahme bzw. jedem Akkuwechsel wird ein Regenerierungsverfahren ausgeführt. Das Verfahren dauert ca. 3 - 4 Tage. Erst danach ist die Leuchte uneingeschränkt einsatzbereit.

Dauertests

Der erste Dauertest erfolgt ca. 8 Tage nach dem Regenerierungsverfahren. Dieser wird alle 12 Wochen durchgeführt, um die Lebensdauer der Akkus zu optimieren.

Prüfungen

Einzelbatterieleuchten sind gemäß der Vorschriften am Montageort zu testen. Mängel sind sofort zu beheben. Prüfergebnisse sind im Prüfbuch zu dokumentieren.

Quittieren

Wenn beim Test Fehler auftreten, werden diese durch die farbige Status LED an der Leuchte angezeigt. Um die Fehleranzeige nach Behebung des Fehlers zurückzusetzen, muss die Versorgungsspannung der Leuchte kurzfristig abgeschaltet werden.

Check after installation

30 minutes after start up must the green LED on. If the LED is off, it must be detected that the charging is not inhibited due to a missing voltage supply, due to a lineinterruption to the battery or due to a faulty electronic.

Optimizing the lifetime of the battery

With every start up or battery change a regeneration process will be performed. The process takes a time of 3 until 4 days. After that the luminaire is absolutely ready for use.

Endurance test

The first duration test occurs after 8 days after the regeneration process. This one will carried out every 12 weeks, to optimize the battery life.

Tests

Self-contained luminaires had to tested at their mounting location in compliance with the regulations. Any defects have to be repaired immediately. Test results need to noted.

Acknowledging error status

If failure will displayed, these are indicated by colored status LED on luminaire. Reset the error status after testing, the luminaire has to be disconnected from mains voltage temporarily.



MULTIDIGIT air

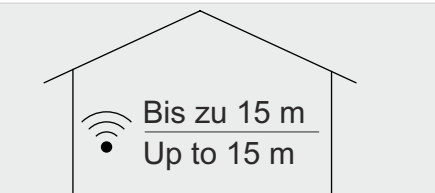

Die Reichweite des Funksignals hängt von der Umgebung ab.
The range of the radio signal depends on the environment.

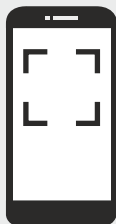

App Guide MULTIDIGIT air

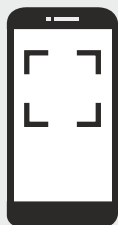

MULTIDIGIT air



1. Schritt: Sensor im Bluetooth Mesh Netzwerk koppeln
2. Schritt: Sicherheitsbeleuchtung im MULTIDIGIT AIR Netzwerk koppeln

1. Step: Pair the sensor in the bluetooth Mesh network
2. Step: Pair the emergency lighting in MULTIDIGIT AIR network

● ON

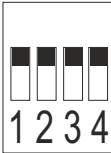

○ OFF

[mA]	P ₀ [W]	CCT 3000		CCT 4000			
		Φ [lm]	Φ [lm]	Φ [lm]	Φ [lm]		
300	13	1700	1750	700	30	4100	4200
350	16	2050	2100	750	32	4400	4500
400	18	2350	2400	800	34	4650	4800
450	20	2650	2700	850	36	4950	5100
500	22	2950	3000	900	38	5250	5400
550	24	3200	3300	950	40	5550	5700
600	26	3500	3600	1000	43	5850	6000
650	28	3800	3900	1050	44	5950	6150

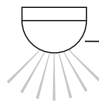

<https://www.rzb.de/fileadmin/assets/downloads/PDF/Koolmesh-App-Bedienungsanleitung-DE-210115.pdf>

<https://www.rzb.de/fileadmin/assets/downloads/PDF/Koolmesh-App-User-Manual-EN-2.0.pdf>

Bluetooth 5.0 SIG mesh



for iOS



for Android



EU-Konformitätserklärung
EU Declaration of Conformity
Déclaration UE de conformité
Declaración UE de conformidad
Deklaracja zgodności UE



Hersteller, Anschrift:
Manufacturer, address:
Fabricant, adresse:
Fabricante, dirección:
Producent, adres:

RZB Rudolf Zimmermann, Bamberg GmbH
Rheinstrasse 16
96052 Bamberg
Deutschland / Germany / Allemagne / Alemania / Niemcy

Wir erklären in alleiniger Verantwortung, dass das Produkt
We declare under sole responsibility that the product
Nous déclarons, sous notre propre responsabilité, que le produit
Declaramos bajo nuestra sola responsabilidad que el producto
Deklarujemy z pełną odpowiedzialnością, że produkt

Produktbezeichnung:
Product designation:
Description des produits:
Designación de producto:
Oznaczenie produktu:

Mondana
672835.002.3.19.F1

mit den folgenden EU-Richtlinien und Normen übereinstimmt:
complies with the following EU Directives and standards:
est conforme aux normes et directives de l'UE suivantes:
cumple con las siguientes directivas y normas CE:
jest zgodny z następującymi dyrektywami UE i normami:

RED Directive 2014/53/EU	(3.1a) EN 60598-1:2021/A11:2022 EN 60598-2-1:1989 EN 60598-2-2:2022 EN 62471:2008 EN 62493:2010 (3.1b) EN 55015:2019/A11:2020 EN 61000-3-2:2019/A1:2021 EN 61000-3-3:2013/A2:2021 EN 61547:2023 (3.2) EN 300 328 V2.2.2
RoHS Directive 2011/65/EU	EN 63000:2018
ErP Directive 2009/125/EC	(EU) 2019/2020

Dokument-Nr. / Document No. / Document No.
Document No. / Nr dokumentu

25060171

Aussteller / Issuer / Délivré par:
Otagante / Wystawca:

RZB Rudolf Zimmermann, Bamberg GmbH

Ort, Datum / Place, Date / Lieu, date:
Lugar, Fecha / Miejsce, data:

Bamberg, 30.04.2025

Rechtsverbindliche Unterschrift:
Legally binding signature:
Signature juridiquement obligatore:
Firma legalmente vinculante:
Prawnie wiazacy podpis:

Reiner Jürgens
CEO/Direktor Zarządzający/Geschäftsführer

INSTRUCTION

672835.002.3.19.F1

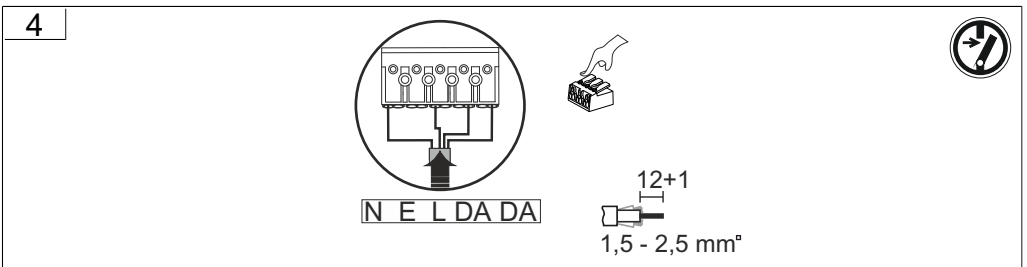
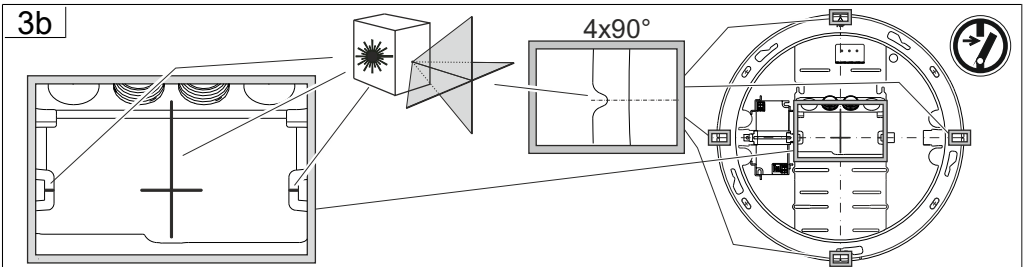
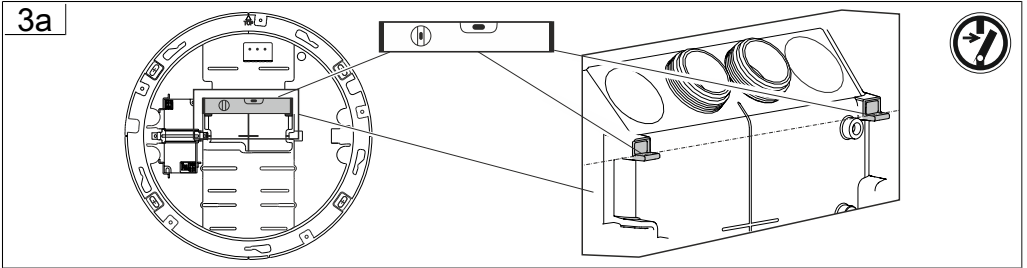
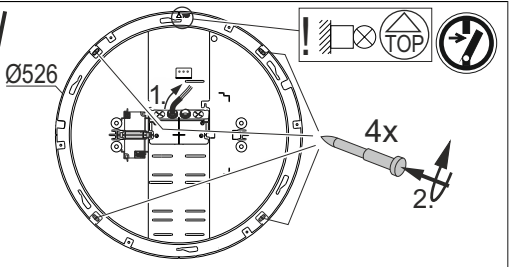
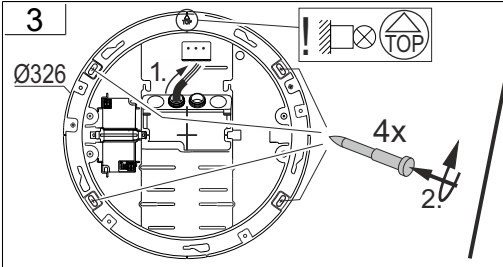
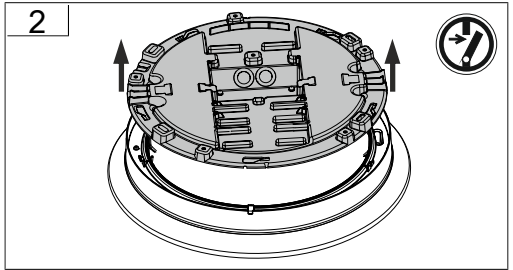
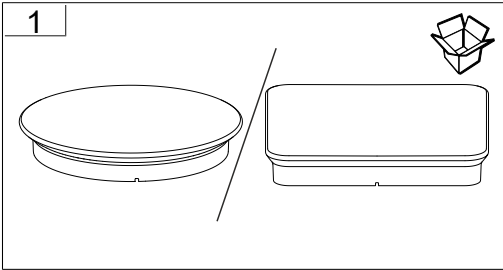
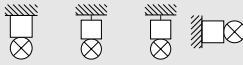



5

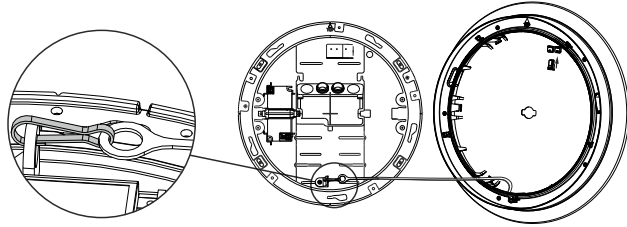
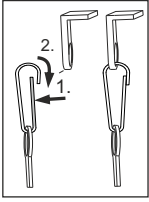

6

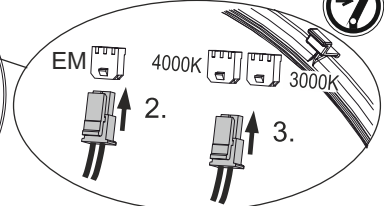
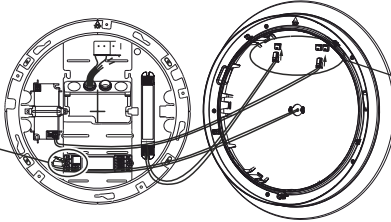
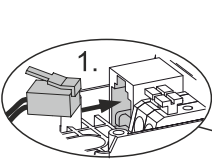

7

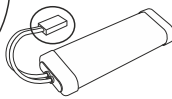
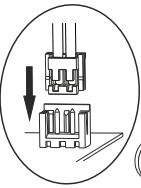
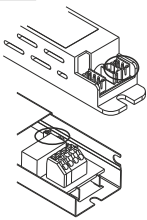

8

Inbetriebnahme Akku / Installation Battery

Datum / Date: XXXX.XXXX

Unterschrift / Signature: *Max Mustermann*

RZB 67XXXX.XXXX Battery X.X V X.X Ah
 X cells type: X-XX
 Permanent charge: XX mA $t_p = XX^\circ\text{C}$
 Production date: 2021 2022 2023 2024 2025 2026
 Installation date: 2021 2022 2023 2024 2025 2026
 WW/YYYY



9

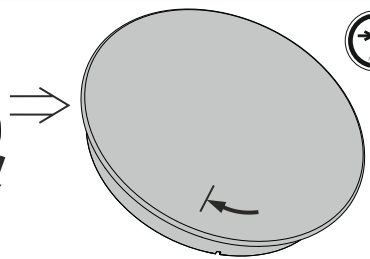
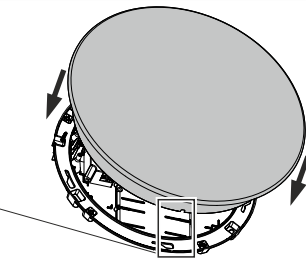
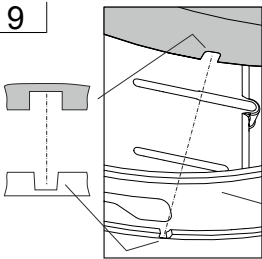

10

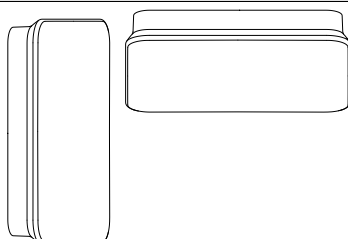
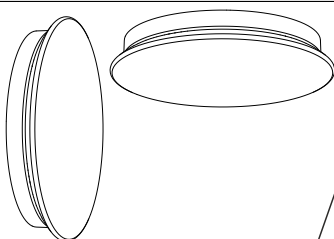



1

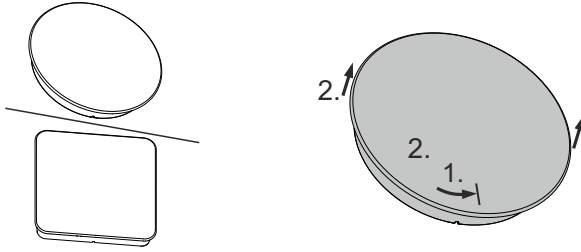

2

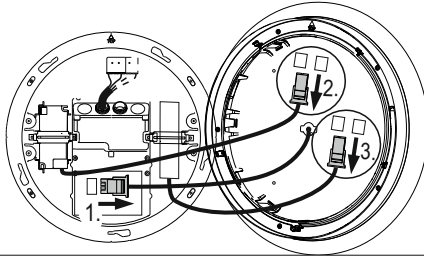

3

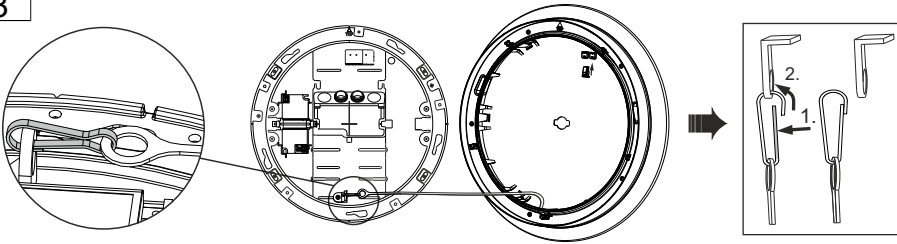

4

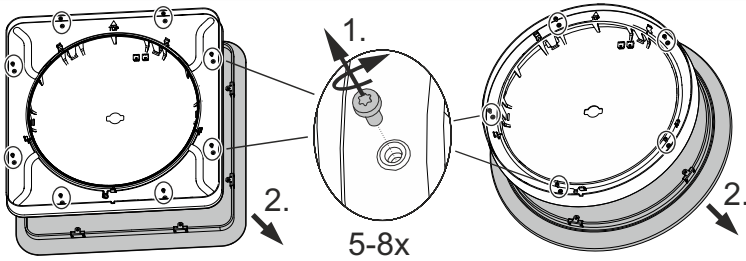

5

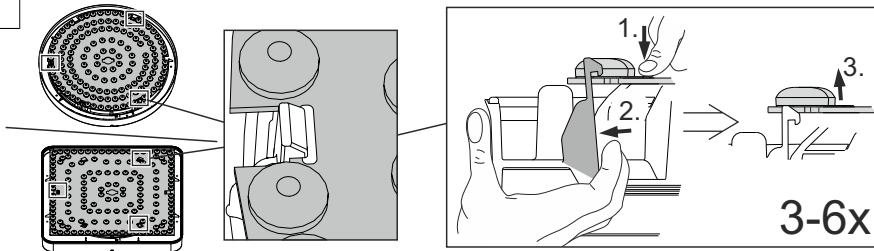

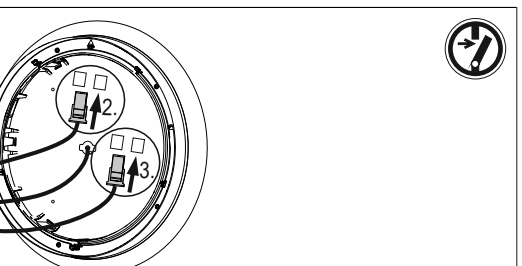
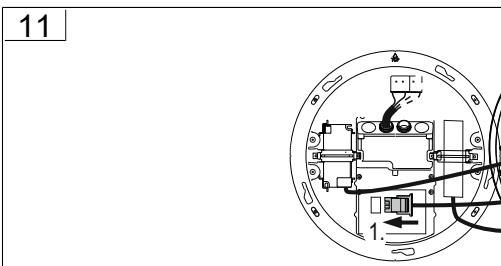
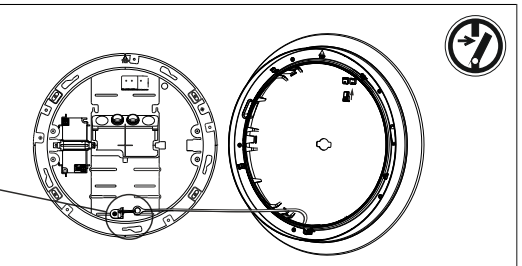
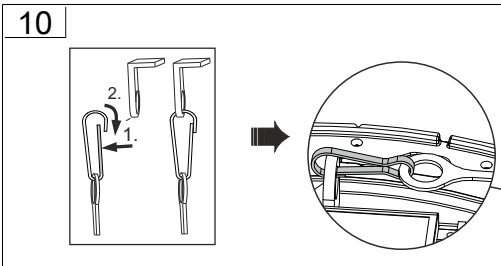
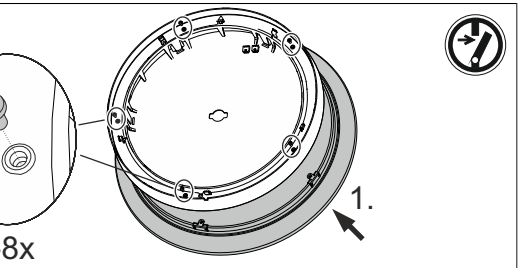
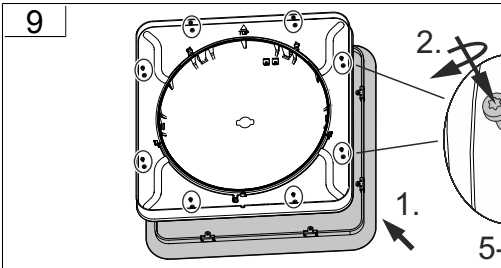
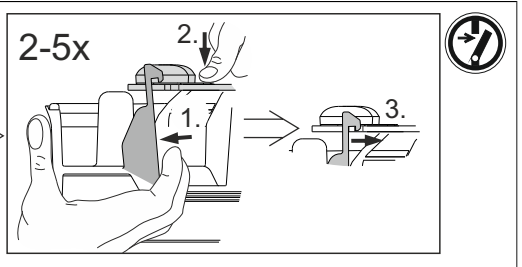
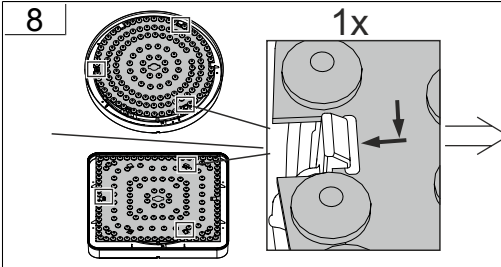
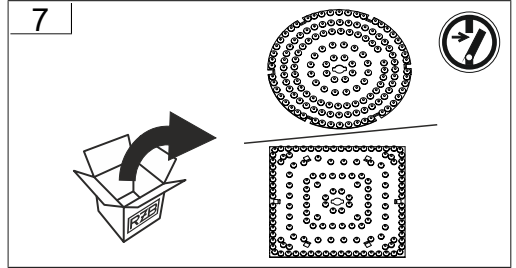
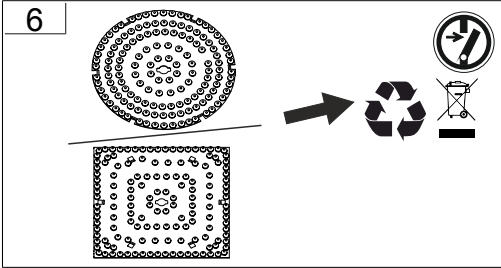



12

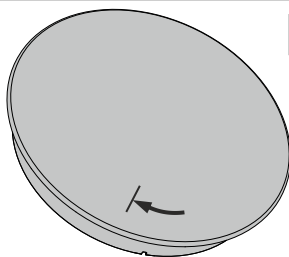
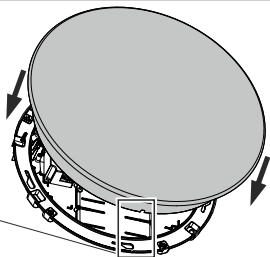
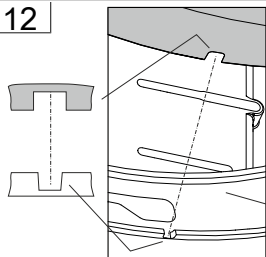

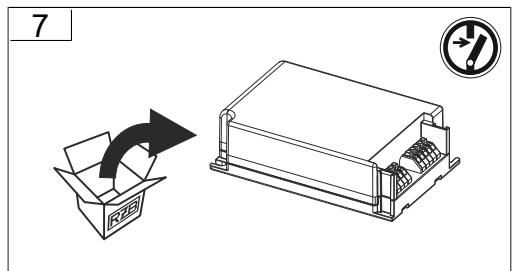
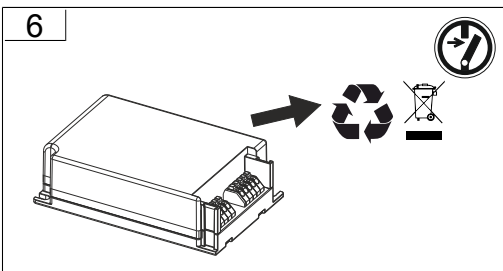
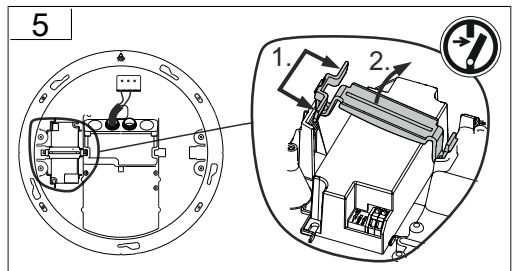
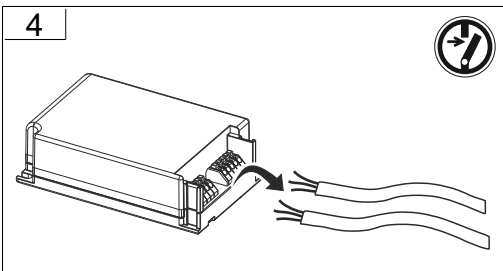
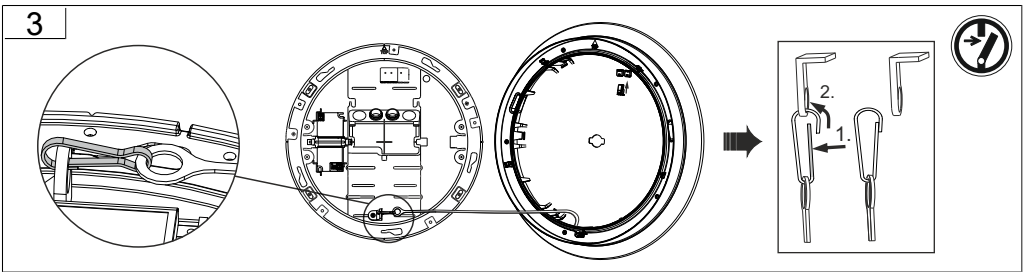
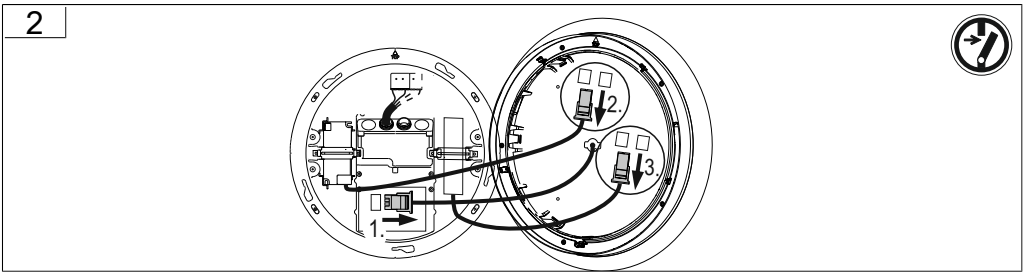
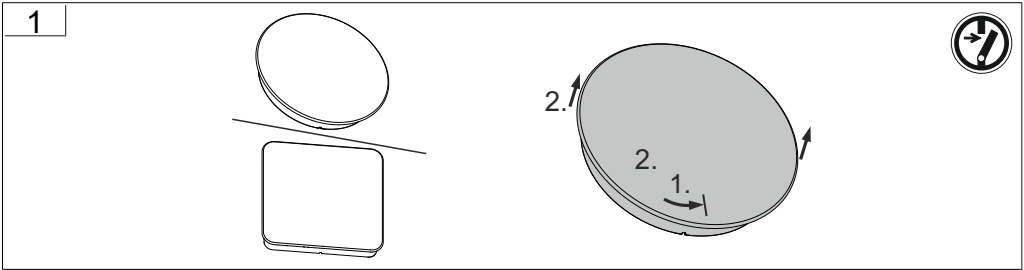



8

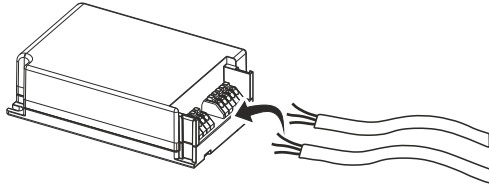

9

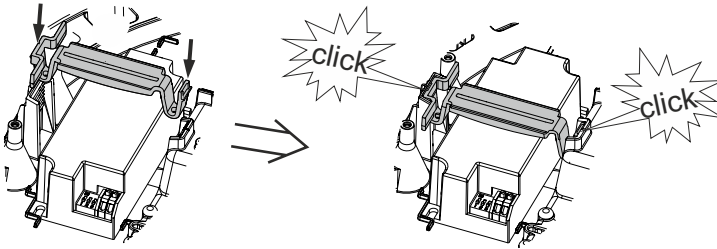

10

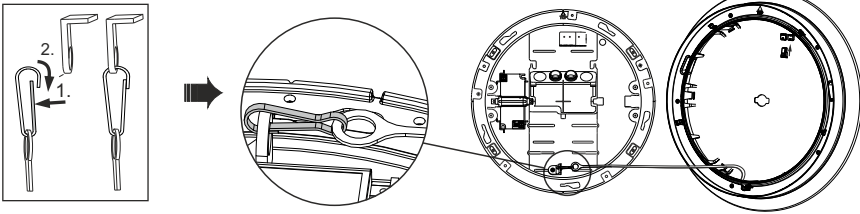

11

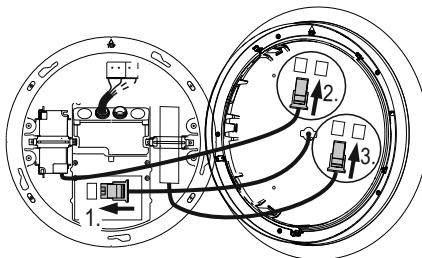

12

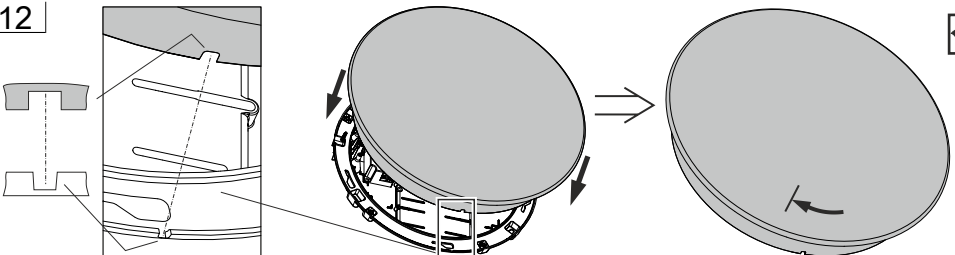

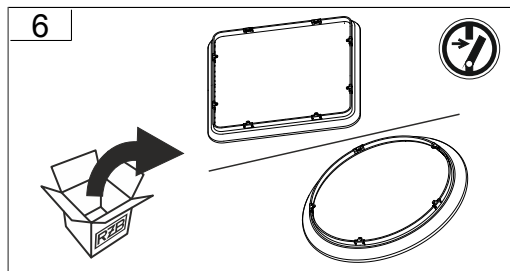
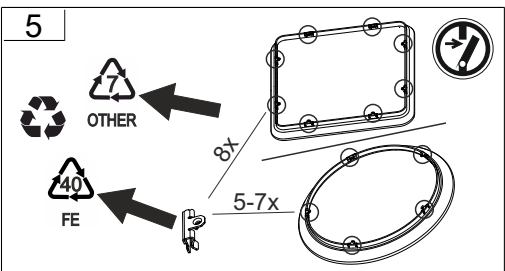
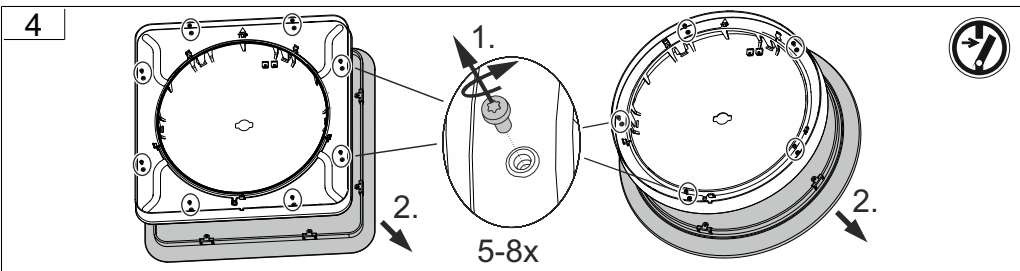
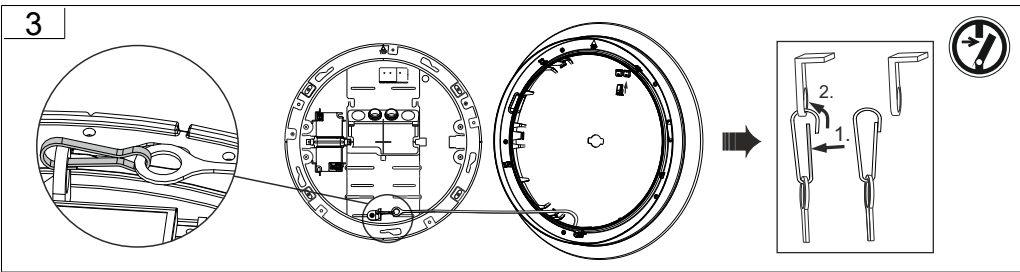
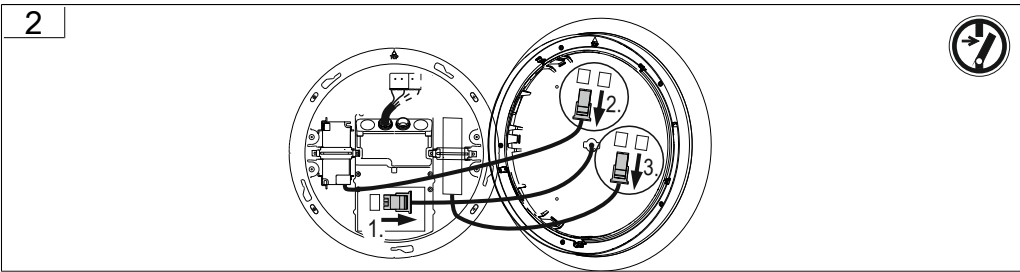
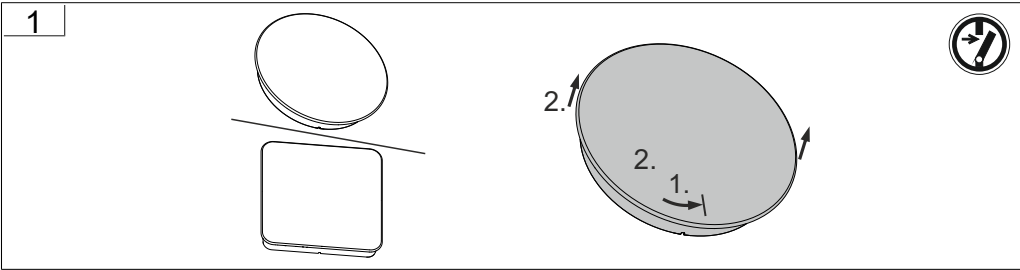

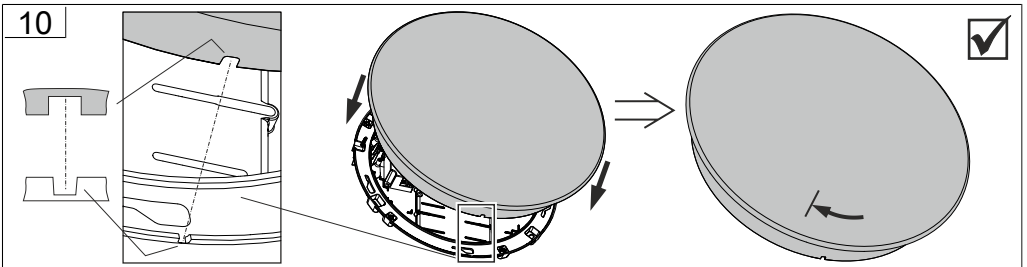
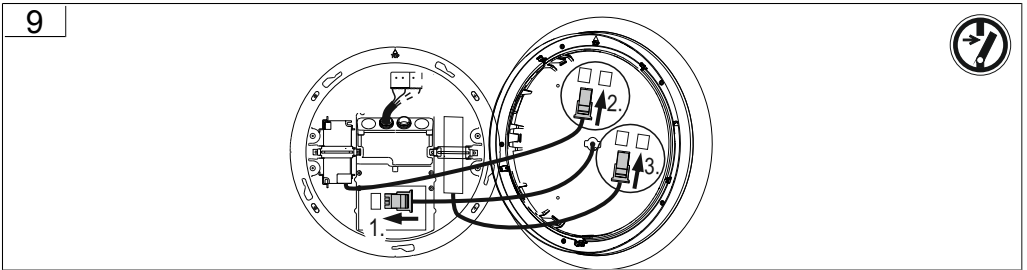
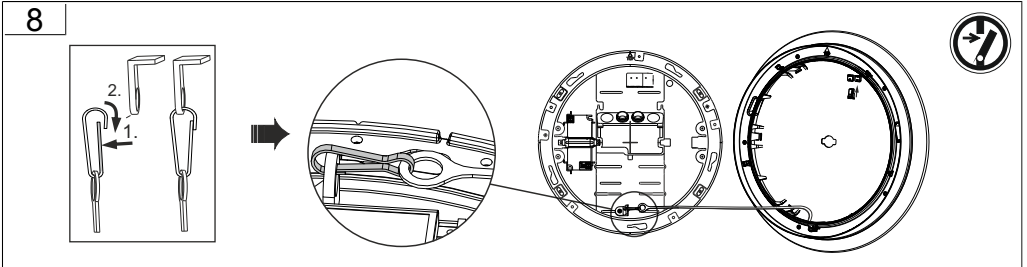
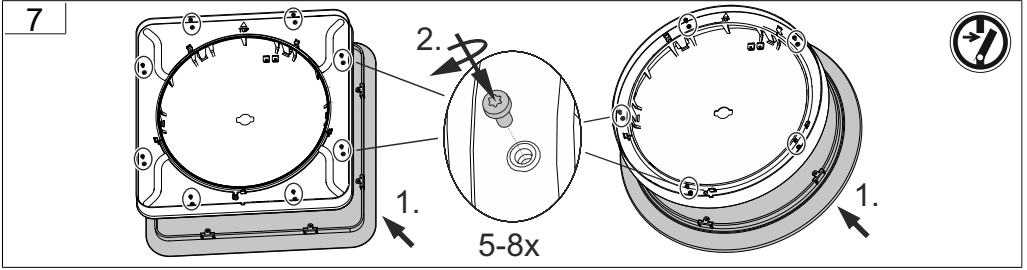

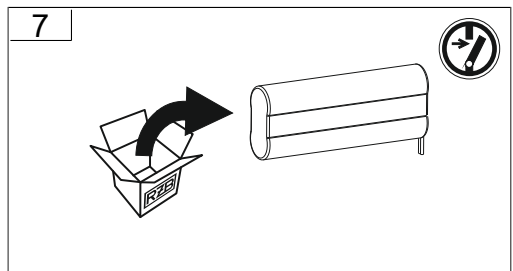
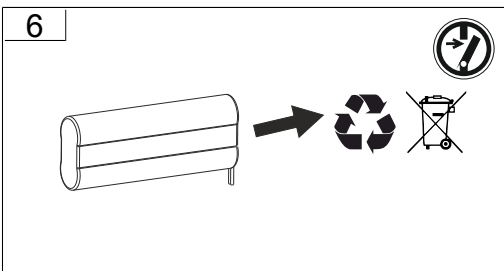
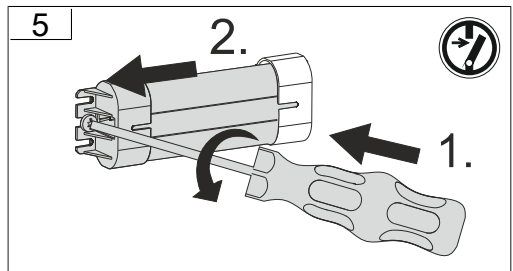
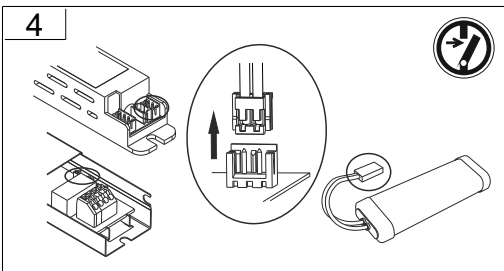
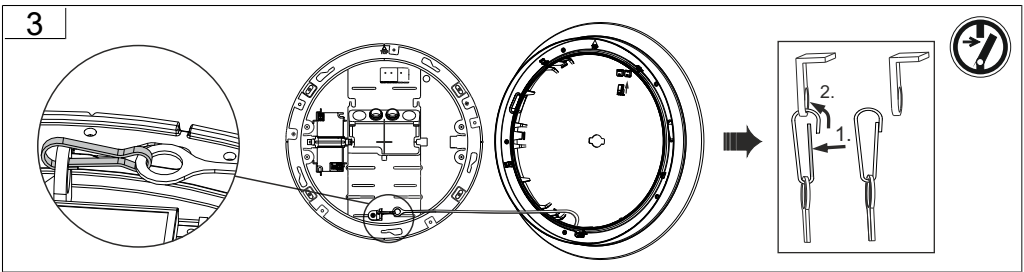
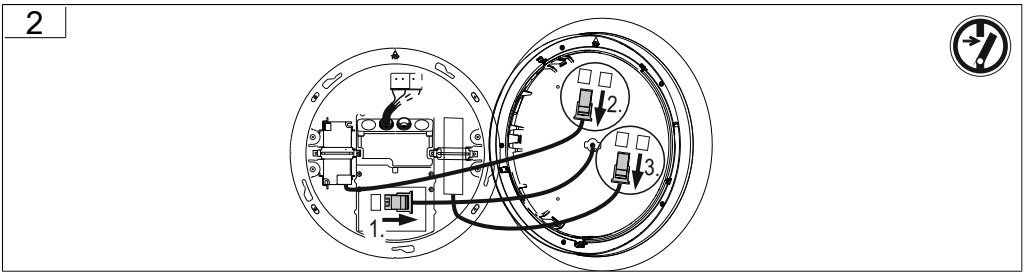
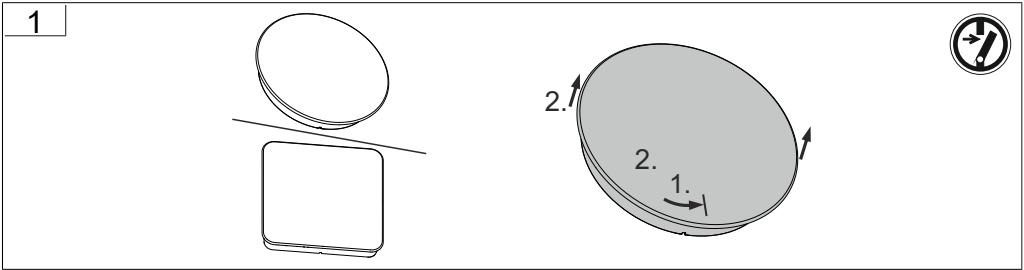
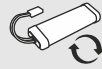

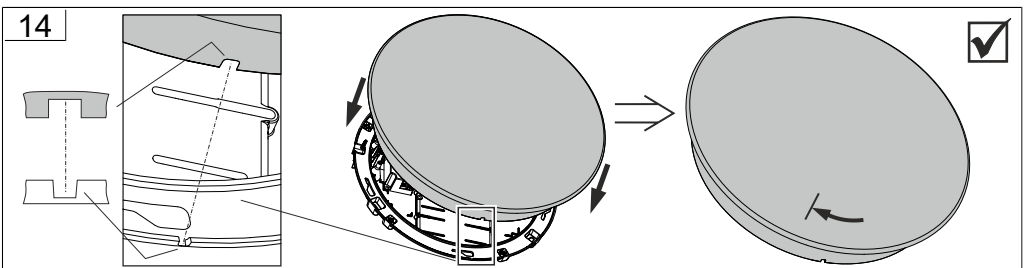
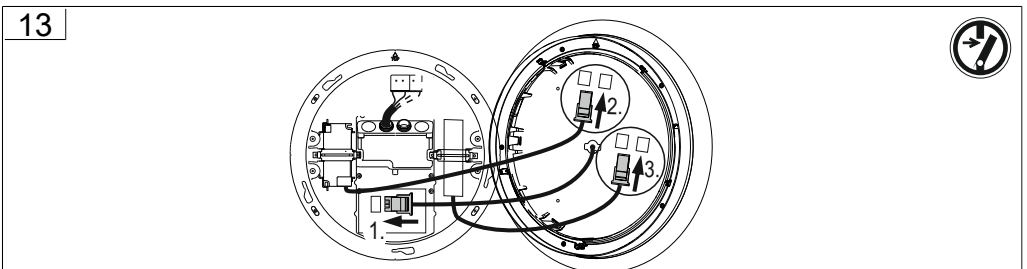
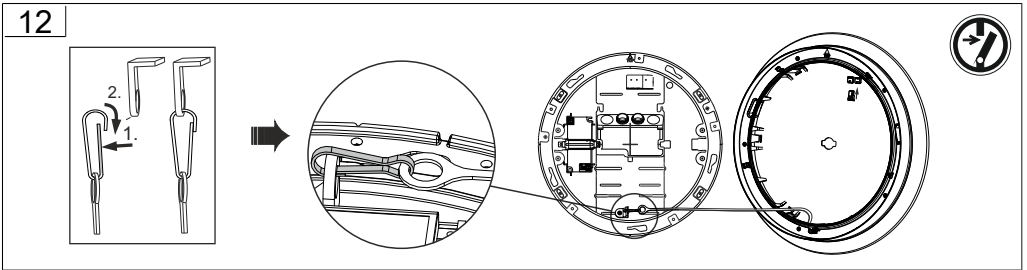
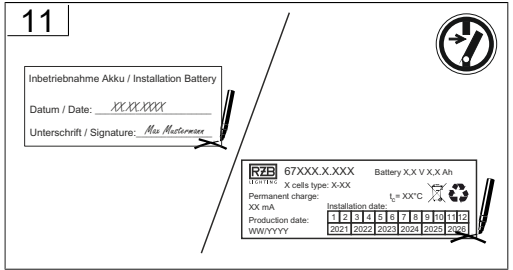
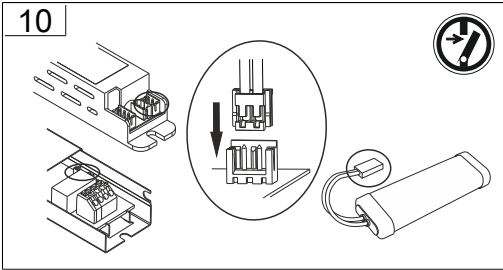
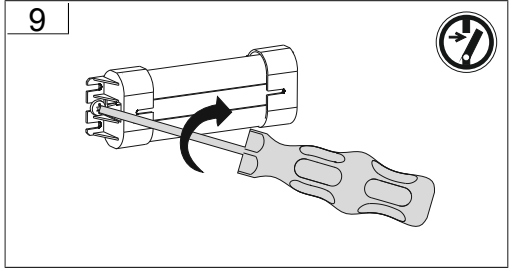
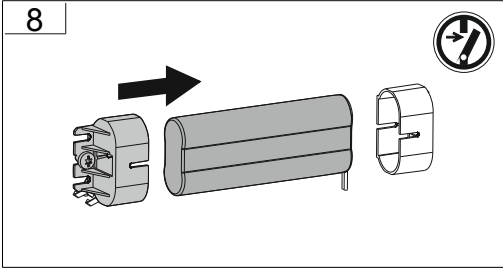
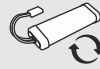

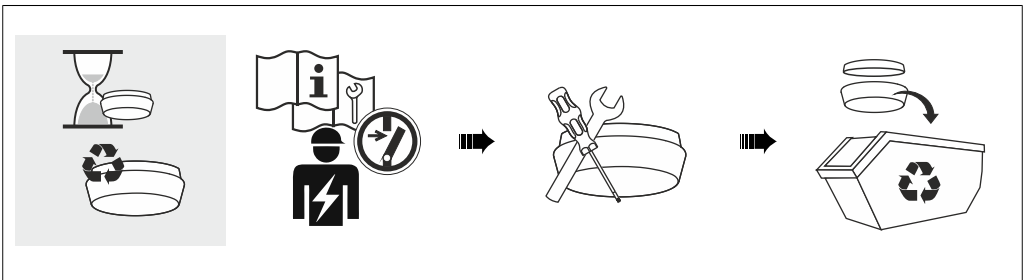
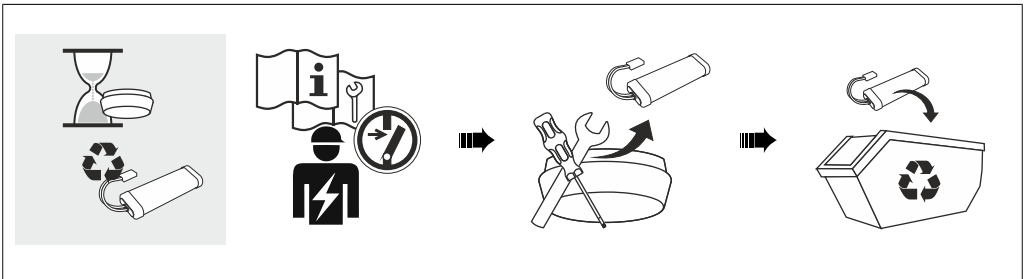
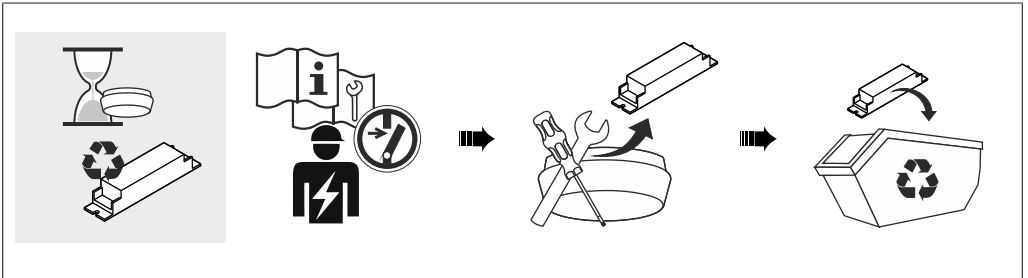
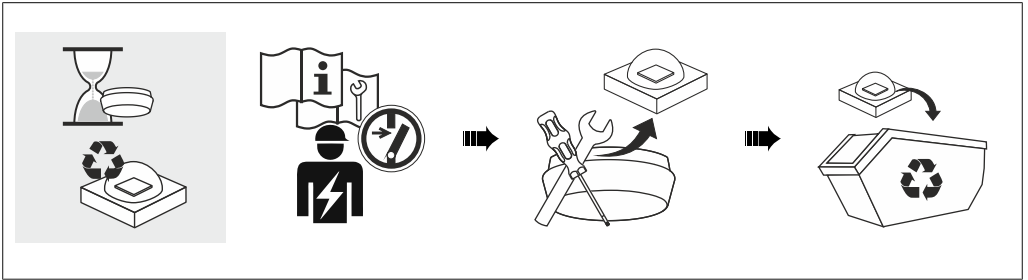



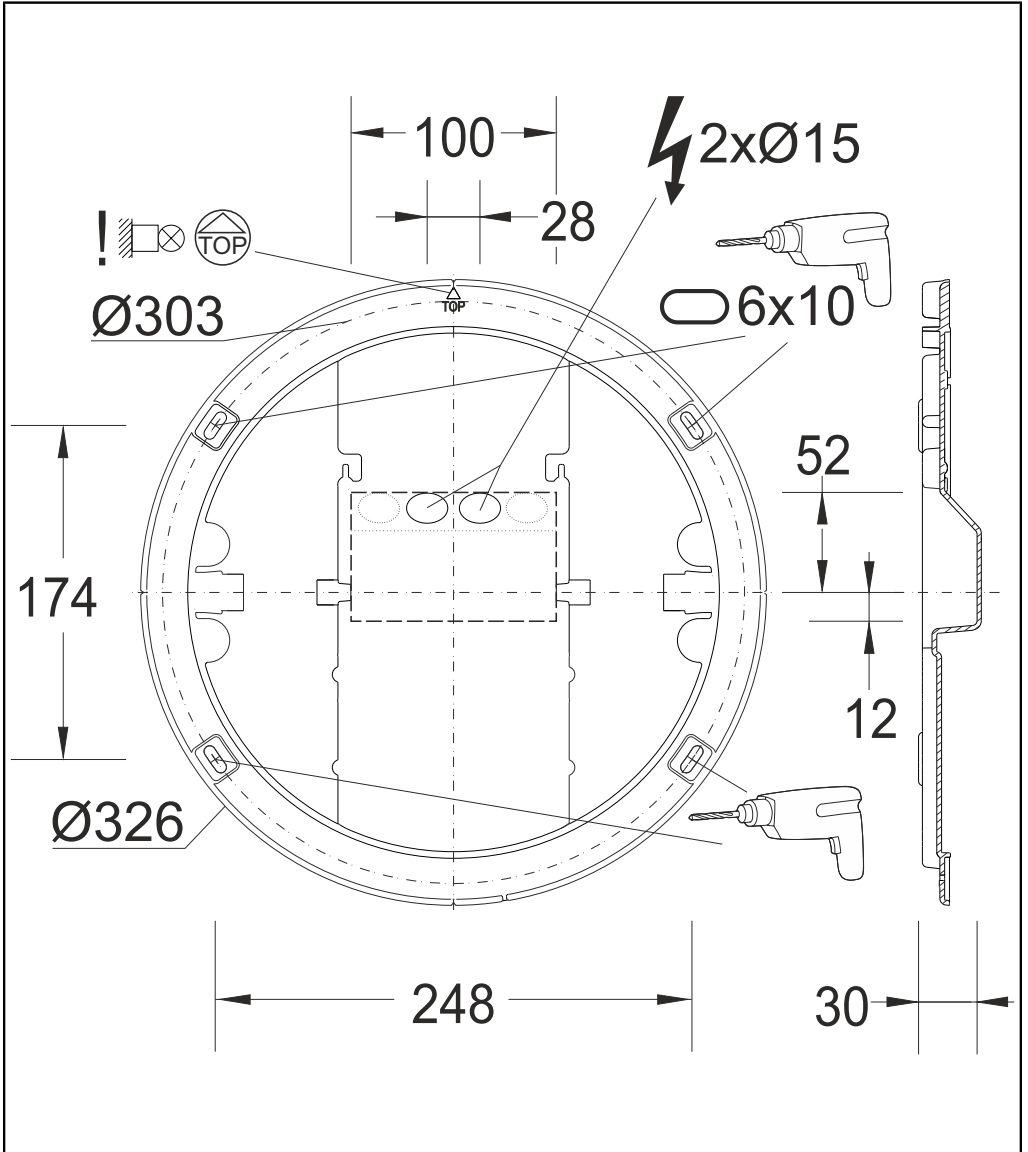

RZB - Rudolf Zimmermann, Bamberg GmbH

🏠 Rheinstraße 16, 96052 Bamberg

☎ 0951/7909-0

📠 0951/7909-198

🌐 info@rzb-leuchten.de