

INSTRUCTION

LINEDO
9523AD.853.400.003

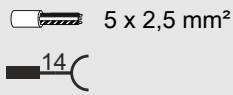

≈ 220 - 240 V 0/50/60 Hz IP 54 IK03



Umgebungstemperatur /
temperature ambiente
=> -25 °C ... + 45 °C

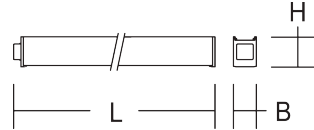
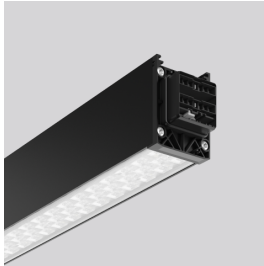

L 2291, B 58, H 76



5,25 kg



Φ [lm]

P_{in} [W]

P_{out}

LED

15300

104

4 x 19,7 W

CCT [K]

CRI

RG

EEK

5000

80

RG 1

C

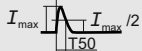

5 A / 1700 μ s



18



32



21



34

$\cos \varphi$

0,98

$f_{\text{min}} - f_{\text{max}}$
[MHz]

13,553 – 13,567

p_{EIRP} [mW]

0



SW 7

SW 14

T25



Allgemeine Sicherheitshinweise

- Der elektrische Anschluss muss ordnungsgemäß nach geltenden Normen und den nationalen sowie internationalen Sicherheits- und Unfallverhütungsvorschriften erfolgen.
- Beschädigte Leuchten dürfen nicht betrieben werden.
- Keine Haftung für Schäden durch unsachgemäßen Einsatz.
- Bei Instandsetzung nur Originalteile verwenden.
- Tragfähigkeit der Decke und Befestigungselemente sicherstellen.

Betrieb der Leuchte

- Die unzulässigen Umgebungstemperaturen reduzieren die Lebensdauer der Leuchte, im Extremfall droht der Frühausfall.
- Zur Vermeidung von EMV-Problemen die Durchgangsverdrahtung nicht entlang der Leuchtenverdrahtung führen.
- Steuereingänge von dimmbaren Leuchten mit handelsüblichen für Netzspannung geeigneten Leitungen anschließen.

Manipulationen unserer Produkte sind unzulässig

Veränderung, Umarbeitung, Umkennzeichnung von Produkten sowie deren Verpackung sind unzulässig und verletzen u.a. unsere eingetragenen Warenzeichenrechte. Solche Modifikationen können technische Eigenschaften unserer Produkte negativ beeinflussen, diese zerstören und möglicherweise Folgeschäden an anderen Objekten verursachen. Für durch derartige Modifikationen verursachte Schäden kann der Hersteller in keinem Fall verantwortlich gemacht werden.



General Safety Information

- Electric connection must be appropriate according to all applicable standards and other national and international safety and accident prevention regulations.
- Damaged luminaires must not be operated.
- No liability is accepted for damages resulting from improper use.
- Use genuine parts only for repair.
- Ensure stability of the ceiling and fastening elements.

Operation of the luminaire

- Exceeding the permissible ambient temperature will reduce the luminaire's lifecycle, resulting in premature failure in extreme cases.
- Avoid ESD problems by not routing feed-through wiring directly along the wiring of the luminaire.
- Connect control inputs of dimmable luminaires with standard cables suitable for power supply voltage.

Manipulation of our products is not permitted

Modifications, reworking, re-labelling of products as well as their package is not permitted and infringes, amongst others, our registered trademark rights. Such modifications may affect technical properties of our products, damage them and possibly cause consequential damage to other objects. The manufacturer shall not be responsible under any circumstances for damage caused by such modifications.



Bei Fragen zu unseren Symbolen, besuchen Sie folgende Webseite:
If you have any questions about our signs, visit the following website:

https://www.rzb.de/fileadmin/assets/downloads/PDF/RZB_Symbolklaerung.pdf

EEK

Dieses Produkt enthält eine Lichtquelle der Energieeffizienzklasse C entsprechend Verordnung (EU) 2019/2015

This product contains a light source of energy efficiency class C according to regulation (EU) No 2019/2015

Jede zersprungene Schutzabdeckung ist zu ersetzen. DIN EN 60598

Replace any cracked protective shield. IEC DIN EN 60598

Die Lichtquelle dieser Leuchte darf nur vom Hersteller oder einem von ihm beauftragten Servicetechniker oder einer vergleichbar qualifizierten Person ersetzt werden. DIN EN 60598-1 / IEC 60598-1

The light source contained in this luminaire shall only be replaced by the manufacturer or his service agent or a similar qualified person. DIN EN 60598-1 / IEC 60598-1



Hinweis zum Einsatz von Leuchten mit D - Kennzeichnung nach EN 60598-2-24

Reference for application of lumiaires with D - marking according to EN 60598-2-24



Umgebung ohne Staubablagerung

Environment without dust deposit



Umgebung mit nicht elektrisch leitender Staubablagerung

Environment with non-electrically conductive dust deposit

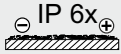

Umgebung mit elektrisch leitender Staubablagerung

Environment with electrically conductive dust deposit

| | |
|--|--------------------------------------|
| | Stecker / Plug |
| | Buchse / Socket |
| | Pendelmontage / Pendant mounting |
| | Deckenmontage / Ceiling mounting |
| | Verdrahtung anpassen / Adapt wiring |
| | Werkseinstellungen / Factory setting |

| | |
|--|--|
| | Pendelmontage / Pendant mounting |
| | Deckenmontage / Ceiling mounting |
| | Einspeisung Mitte / Feed in the middle |
| | Einspeisung Mitte / Feed in the middle |
| | Pendelmontage / Pendant mounting |
| | Einspeisung Anfang von oben / Feed beginning from above |
| | Deckenmontage / Ceiling mounting |
| | Einspeisung Anfang von oben / Feed beginning from above |
| | Pendelmontage / Pendant mounting |
| | Einspeisung Anfang seitlich / Feed beginning from the side |
| | Deckenmontage / Ceiling mounting |
| | Einspeisung Anfang seitlich / Feed beginning from the side |
| | Pendelmontage / Pendant mounting |
| | L-Verbinder / L-Connector |
| | Deckenmontage / Ceiling mounting |
| | L-Verbinder / L-Connector |
| | Deckenmontage / Ceiling mounting |
| | X,T-Verbinder / X,T-Connector |
| | Pendelmontage / Pendant mounting |
| | X,T-Verbinder / X,T-Connector |

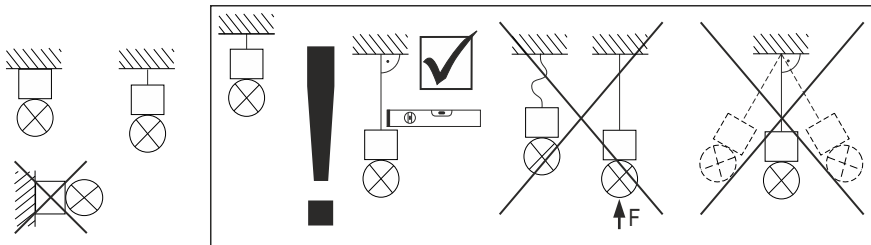



| | L | X* |
|---------|-----------|------------|
| 4547 mm | ≤ 4500 mm | ≤ 60000 mm |
| 2291 mm | ≤ 2270 mm | ≤ 50000 mm |

* $R_{PE} < 0,5 \Omega$
EN 60598

| | L | X* |
|---------|-----------|------------|
| 4547 mm | ≤ 4500 mm | ≤ 60000 mm |
| 2291 mm | ≤ 2270 mm | ≤ 50000 mm |

* $R_{PE} < 0,5 \Omega$
EN 60598

$< 2291 \text{ mm} \geq 1x$

✓

✓

| | L | X* |
|---------|-----------|------------|
| 4547 mm | ≤ 4400 mm | ≤ 60000 mm |
| 2291 mm | ≤ 2100 mm | ≤ 50000 mm |

* $R_{PE} < 0,5 \Omega$
EN 60598

| | L | X* |
|---------|-----------|------------|
| 4547 mm | ≤ 4400 mm | ≤ 60000 mm |
| 2291 mm | ≤ 2100 mm | ≤ 50000 mm |

* $R_{PE} < 0,5 \Omega$
EN 60598

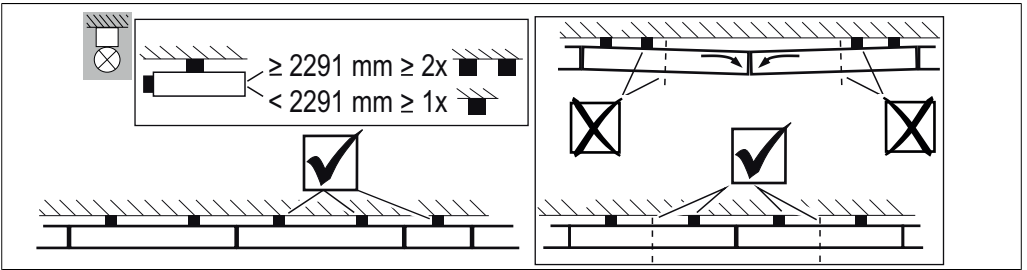



EG-Konformitätserklärung
EC-Declaration of Conformity
Déclaration UE de conformité
Declaración de conformidad CE
Deklaracja zgodności UE



Hersteller, Anschrift:
Manufacturer, address:
Fabricant, adresse:
Fabricante, dirección:
Producent, adres:

RZB Rudolf Zimmermann, Bamberg GmbH
Rheinstrasse 16
96052 Bamberg
Deutschland / Germany / Allemagne / Alemania / Niemcy

Wir erklären in alleiniger Verantwortung, dass das Produkt
 We declare under sole responsibility that the product
 Nous déclarons, sous notre propre responsabilité, que le produit
 Declaramos bajo nuestra sola responsabilidad que el producto
 Deklarujemy z pełną odpowiedzialnością, że produkt

Produktbezeichnung:**Product designation:****LINEDO****Description des produits:****9523AD.853.400.003****Designación de producto:****Oznaczenie produktu:**

mit den folgenden EG-Richtlinien und Normen übereinstimmt:

complies with the following EC Directives and standards:

est conforme aux normes et directives de l'UE suivantes:

cumple con las siguientes directivas y normas CE:

jest zgodny z następującymi dyrektywami UE i normami:

| | |
|---|---|
| <p>RED Directive 2014/53/EU</p> | <p>(3.1a) EN 60598-1:2021/A11:2022 EN 60598-2-1:1989 EN 62471:2008 EN 62493:2010 (3.1b) EN 55015:2019/A11:2020 EN 61000-3-2:2019/A1:2021 EN 61000-3-3:2013+A1:2019+A2:2021+A2:2021/AC:2022 EN 61547:2023 (3.2) EN 300 330:V2.1.1</p> |
| <p>RoHS Directive 2011/65/EU</p> | <p>EN 63000:2018</p> |
| <p>ErP Directive 2009/125/EC</p> | <p>(EU) 2019/2020</p> |

Dokument-Nr. / Document No. / Document No.
 Document No. / Nr dokumentu

24012227

Aussteller / Issuer / Délivré par:
 Otorgante / Wystawca:

RZB Rudolf Zimmermann, Bamberg GmbH

Ort, Datum / Place, Date / Lieu, date:

Bamberg, 02.02.2024

Lugar, Fecha / Miejsce, data:

Rechtsverbindliche Unterschrift:

Legally binding signature:

Signature juridiquement obligatoire:

Firma legalmente vinculante:

Prawnie wiązacy podpis:

 Reiner Jürgens
 CEO/Direktor Zarządzający/Geschäftsführer

1/1



1



2



3

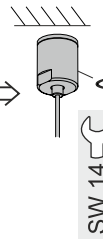
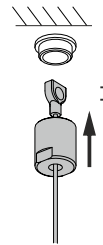
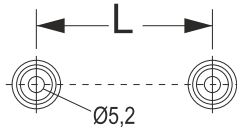

4

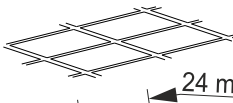
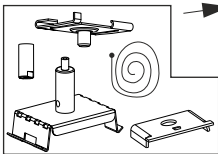

24 mm

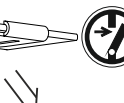
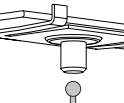
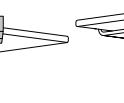
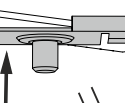
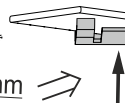

5a

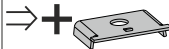
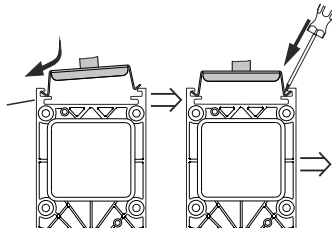
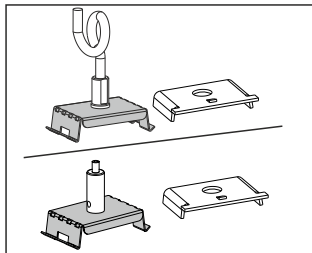

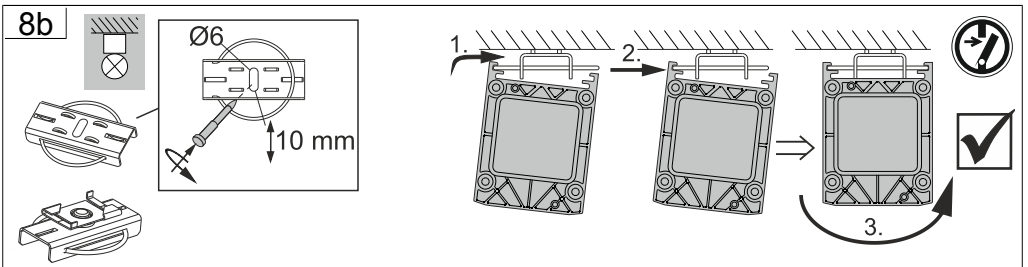
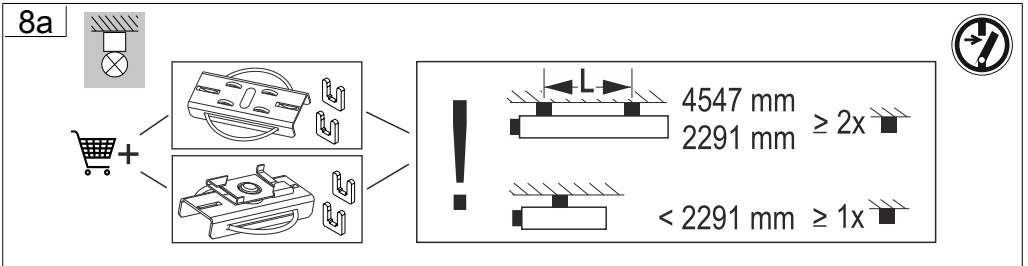
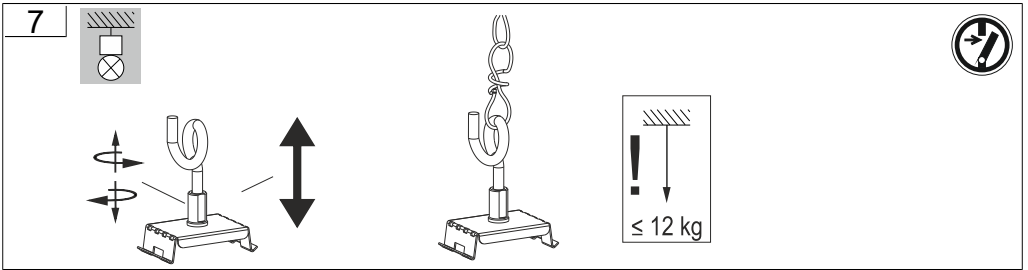
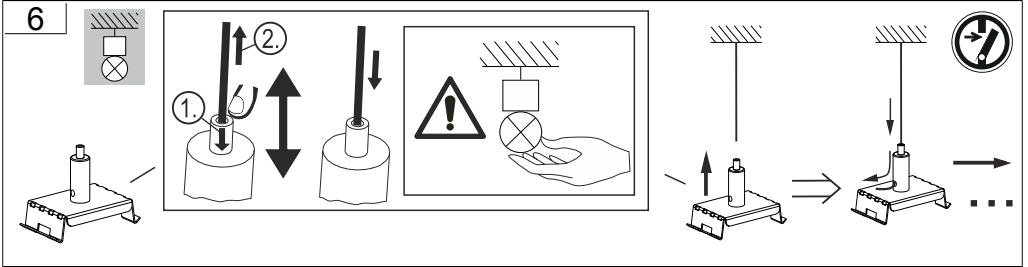
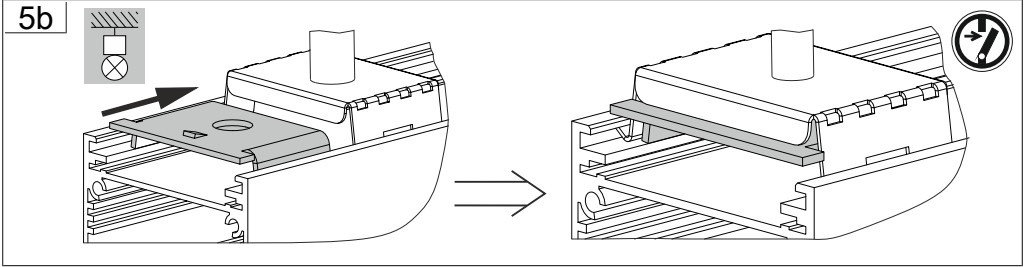

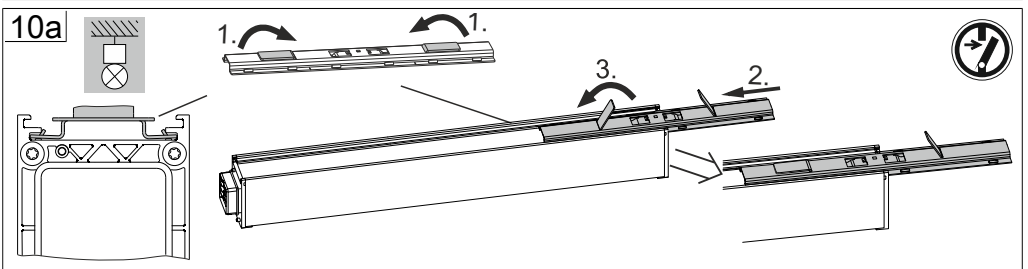
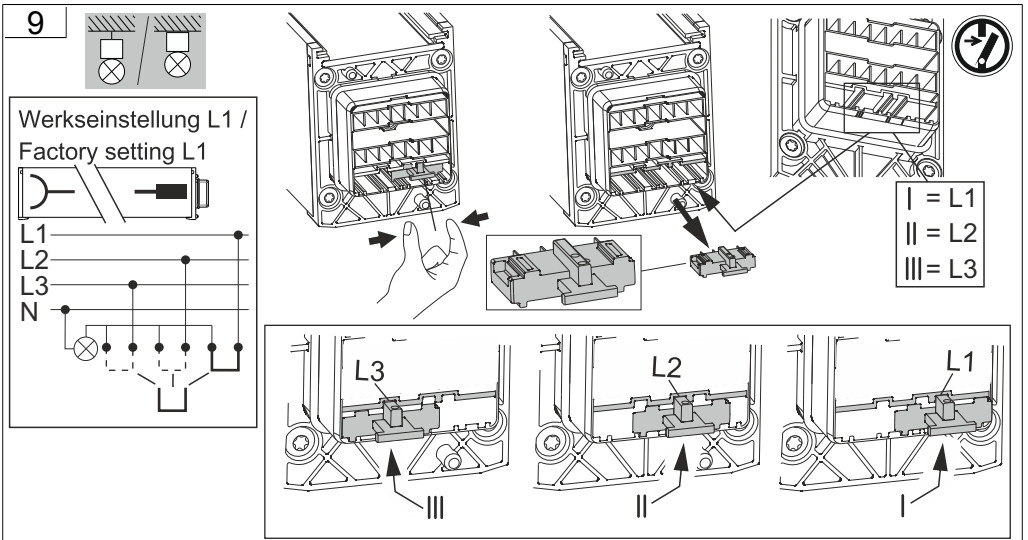
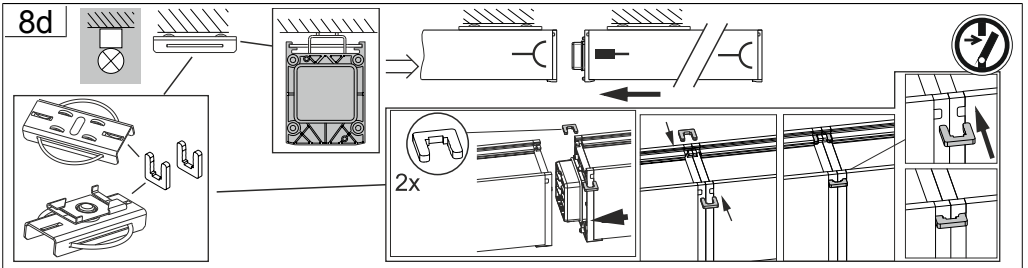
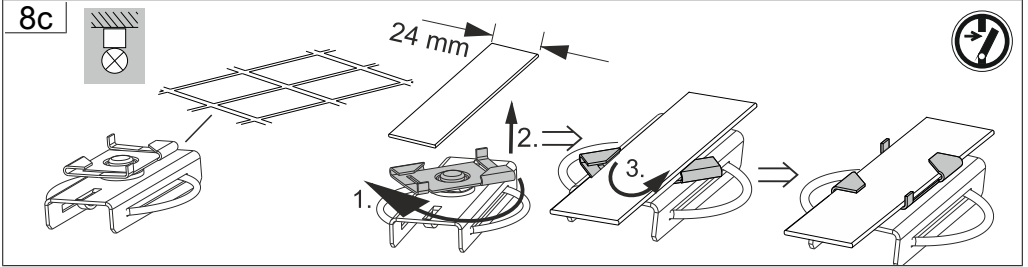



10b



10c



11



12a

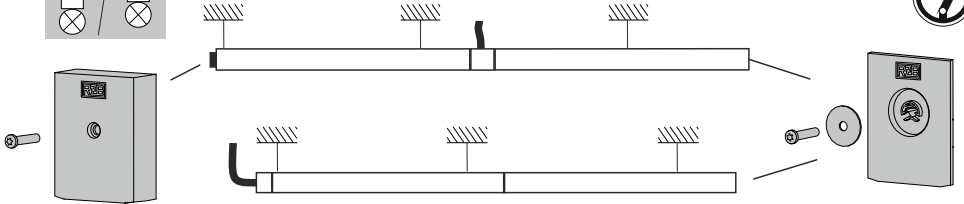
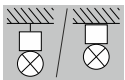

12b

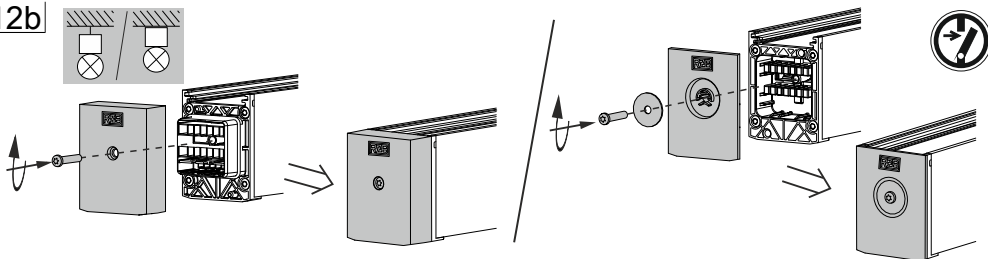
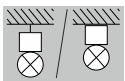



13

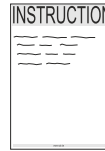
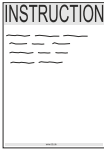
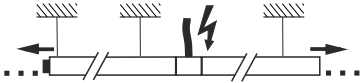

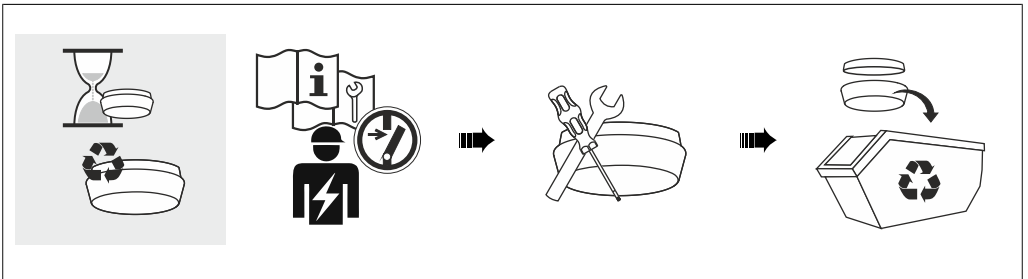
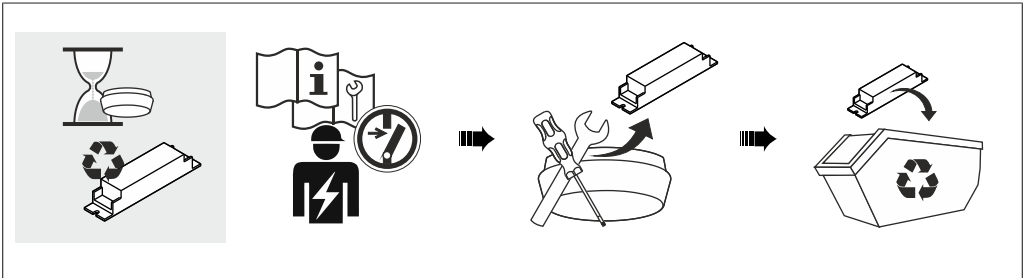
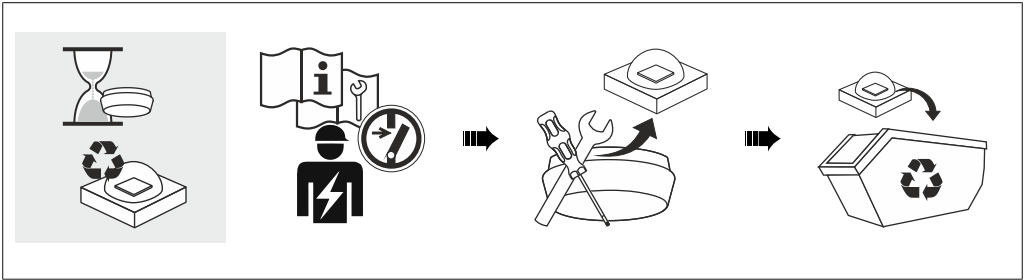





RZB - Rudolf Zimmermann, Bamberg GmbH

 Rheinstraße 16, 96052 Bamberg

 0951/7909-0

 0951/7909-198

 info@rzb-leuchten.de