

INSTRUCTION

09-0664.022
04-2014



TENUO | Deckeneinbauleuchte
recessed ceiling luminaire

Zentralbatterie/ central battery

IP40 (IP20)

 LED
 220 - 240 V / 0/50-60 Hz
 3 x 1,5mm²(2,5mm²)
 0,5mm² - 2,5mm²
 3 x 1,5mm²(2,5mm²) + 2 x 1,5mm²(2,5mm²) nur bei .72/.82 only for .72/.82

5-35

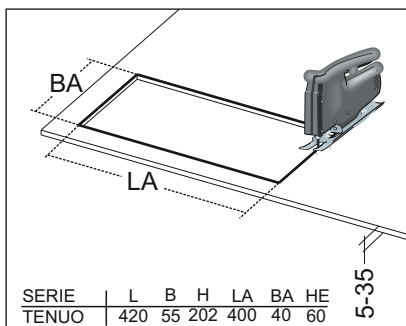
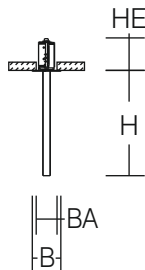
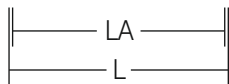
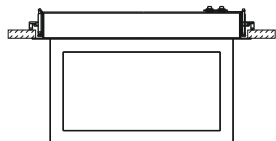

SERIE	L	B	H	LA	BA	HE
TENUO	420	55	202	400	40	60



Zentralbatterie/central battery

	671940.004	L 420, B 55, H 202	LED Modul 5W	5,6W	30m	1,97
	671940.004.71	L 420, B 55, H 202	LED Modul 5W	5,6W	30m	2,03
	671940.004.72	L 420, B 55, H 202	LED Modul 5W	5,6W	30m	2,05
	671940.004.81	L 420, B 55, H 202	LED Modul 5W	5,6W	30m	2,01
	671940.004.82	L 420, B 55, H 202	LED Modul 5W	5,6W	30m	2,02
	672030.004	L 420, B 55, H 202	LED Modul 2,5W	4,5W	30m	2,07
	672030.004.71	L 420, B 55, H 202	LED Modul 2,5W	4,5W	30m	2,13
	672030.004.72	L 420, B 55, H 202	LED Modul 2,5W	4,5W	30m	2,15
	672030.004.81	L 420, B 55, H 202	LED Modul 2,5W	4,5W	30m	2,11
	672030.004.82	L 420, B 55, H 202	LED Modul 2,5W	4,5W	30m	2,12

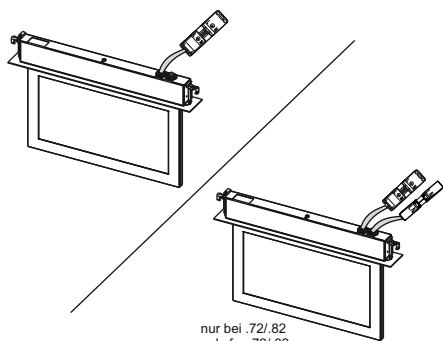

nur bei .72/.82
only for .72/.82

Unsere Sicherheitsleuchten sind entsprechend den aktuell gültigen Leuchtenbauvorschriften gekennzeichnet. Die Form der Kennzeichnung ist wie folgt, als Beispiel dargestellt.

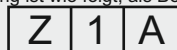

Feld 1: Bauart, Feld 2: Betriebsart, Feld 3: Einrichtungen wie Selbsttest u.s.w.

Die von uns gelieferten Leuchten sind als Leuchten in Dauerschaltung gekennzeichnet. Wollen Sie die Leuchten in Bereitschaftsschaltung betreiben, muß der Eintrag in Feld 2 geändert werden. Bitte kennzeichnen Sie dann 1-lampige Leuchten mit 0 anstatt der 1 und mehrlampige Leuchten mit 2 anstatt der 3.

Our safety luminaires are marked according to the currently valid construction standards.

The type of marking can be seen in the following example.

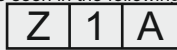

Field 1: Type of construction, Field 2: Type of operation, Field 3: Additional features such as self test etc.

The default type of operation of our luminaires is maintained. If you change the type of operation to non-maintained you will have to change the entry in field 2 Please change the "1" to "0" for luminaires equipped with 1 lamp and "3" to "2" for luminaires equipped with more than one lamp.

EN 12464



EN 12464



RZB Rudolf Zimmermann, Bamberg GmbH
Rheinstraße 16
D-96052 Bamberg
Deutschland
Telefon +49 951/79 09-0
Telefax +49 951/79 09-198
www.rzb.de
info@rzb-leuchten.de



1

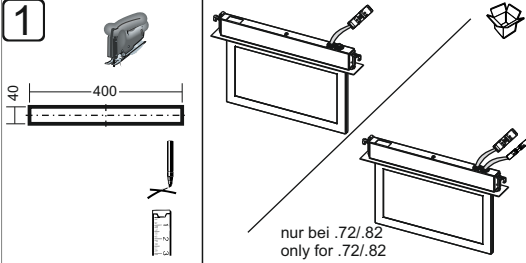

nur bei .72/.82
only for .72/.82

2.1

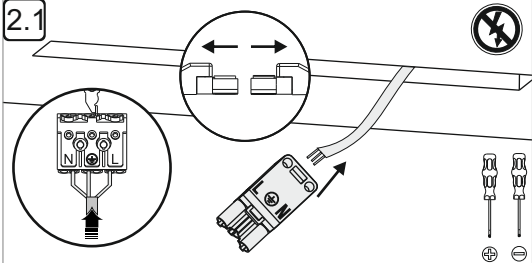

2.2 nur bei .72/.82
only for .72/.82

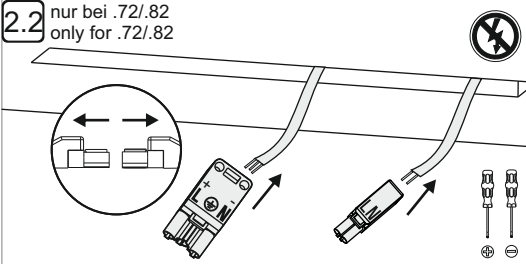

3.1 nur bei .71/.72/.81/.82
only for .71/.72/.81/.82

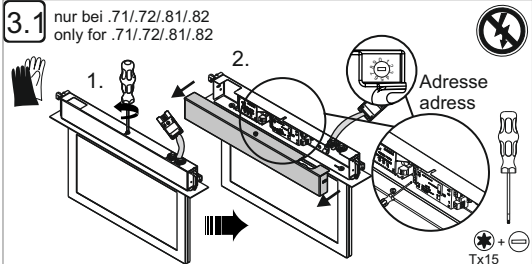

Adresse
address

Tx15

3.2 nur bei .71/.72/.81/.82
only for .71/.72/.81/.82

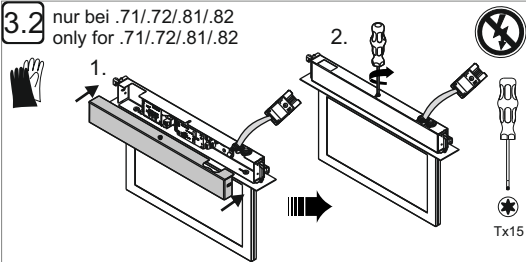

Tx15

4

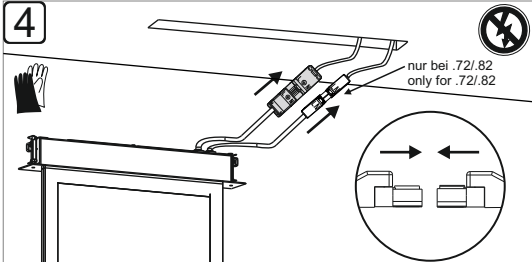

nur bei .72/.82
only for .72/.82

5

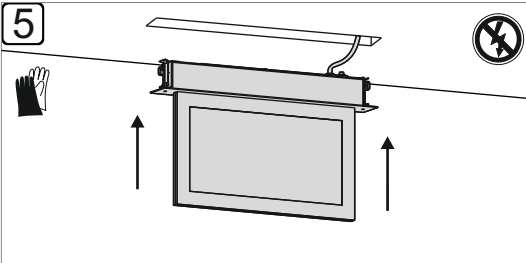

6

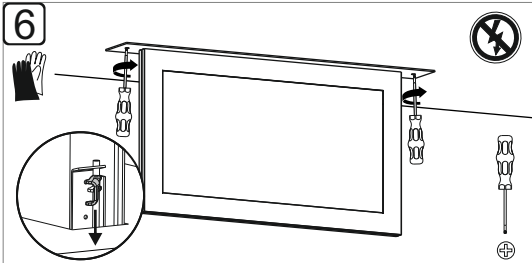

7

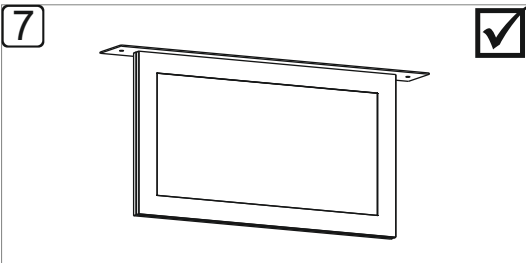

!

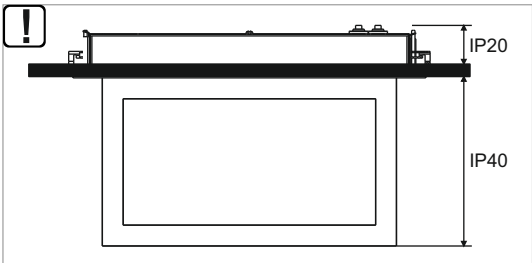

IP20
IP40